

SUSTAINABLE AGRICULTURE LITERATURE REVIEW

March 2011



**Prepared for Boulder County Parks and Open Spaces by:
NATURAL CAPITALISM SOLUTIONS**

Cropland Policy

The mission of Boulder County Parks and Open Space (BCPOS) is to conserve natural, cultural, and agricultural resources and provide public uses that reflect sound resource management and community values. The Department manages 25,000 acres of agricultural land 18,000 of those acres are managed as cropland or irrigated pastureland.

BCPOS is in the process of developing a cropland policy to guide management of these lands. The Cropland Policy will tie the Department's daily management practices and the County Comprehensive Plan's broad directives regarding the management of open space and agricultural land. The policy will outline the guiding principles staff will use to make management decisions on open space properties managed as cropland. Defining these principles will streamline decision-making processes during planning and make it easier for open space tenants and the residents of Boulder County to understand the goals of our cropland program.

Visit the department's webpage at www.BoulderCountyOpenSpace.org for more information.

About this Report

This literature review will examine sustainable agriculture practices in an effort to inform the discussion for Cropland Policy for Boulder County Parks and Open Space. It will explore some of the challenges faced by producers and ways in which producers can continue to take a leadership role in making their operations and their communities more sustainable. Agriculture is a critically important part of Boulder County. It helps to keep land as open space, preserve the rural culture, and increase the economic security of the county and its residents. Making wise decisions about the future of agriculture in the county is important to all of its citizens. This report seeks to provide a fact-based foundation for such conversations.

The scope of this literature review is restricted to data-based considerations about approaches and practices related to sustainable agriculture. This report is not intended to give exact answers to problems on specific farms. No opinions, unless supported by experimental results, will be discussed. The emphasis will be on papers published in peer-reviewed journals, with additional non-peer-reviewed journals included only if they influence the development of science-based ideas or if data were unavailable. In these instances, the non-peer reviewed data will be noted.

If printing this report, please print on recycled content paper.

This publication was prepared by Natural Capitalism Solutions (NCS)
a 501c3 non-profit based in Hygiene, Colorado.
www.natcapsolutions.org



Table of Contents

Executive Summary	7
1. Climate	9
1.1 Climate of Northern High Plains Colorado	10
1.2 Potential Impacts of Climate Change	14
1.3 Agricultural Impacts to the Atmospheric Climate.....	17
1.4 Mitigation and Sequestration of GHG Emissions in Agriculture	19
2. Energy	24
2.1 Breakdown of Energy Use.....	25
2.2 Energy Generation	31
3. Water Use	36
3.1 Supply and Demand.....	37
3.2 Irrigation Management	40
3.3 Water Conservation.....	45
4. Water Pollution	48
4.1 Agricultural Water Pollution	49
4.2 Sediment Pollution	50
4.3 Fertilizers as Water Pollutants.....	51
4.4 Pesticides as Water Pollutants.....	53
5. Soil Health	55
5.1 Overview of Soils in Boulder County	56
5.2 Soil Conservation	56
5.3 Organic Matter, Cover Crops, and Green Manures	64
5.4 Soil Amendments	69
6. Inputs	73
6.1 Agricultural Use of Inputs	74
6.2 Fertilizers.....	76
6.3 Pesticides	79
6.4 Seeds	79
6.5 Current Regulations	82
7. Pest Management	87
7.1 Pesticide Usage	88
7.2 Application Rates of Pesticides	92
7.3 Pesticide Resistance	98
7.4 Integrated Pest Management.....	100
8. Biodiversity	101
8.1 Food Security	102
8.2 Impact of Reduced Biodiversity.....	104
8.3 Management	108
9. Labor	112
9.1 Agricultural Employment	113
9.2 Demographics	115
9.3 Occupational Health and Performance	117

10. Human Health	121
10.1 Food Safety.....	122
10.2 Health Effects.....	123
11. Local Economy	129
11.1 Income.....	130
11.2 Farm Size.....	130
11.3 Infrastructure.....	133
11.4 Competing Resource Use.....	134
11.5 Direct Marketing.....	137
Glossary of Terms	139



List of Figures

Figure 1: Precipitation Rates for Western U.S. 2009-2010	12
Figure 2: Projected Change in Spring Precipitation, 2080-2099	15
Figure 3: Historical and Forecast GHG Emissions for Boulder County by Sector (tCO ₂ e)	18
Figure 4: Global GHG Emissions of Agricultural Practices.....	18
Figure 5: Potential Measures for Mitigating GHG Emissions from Agricultural Land and Operations	20
Figure 6: Farm Energy Use by Source	25
Figure 7: Direct Energy Use (DEU) and Agricultural Output (productivity per acre) 1965-1999 ...	27
Figure 8: Correlation Between Natural Gas and Nitrogen Fertilizers	28
Figure 9: Factors Reducing Fuel Efficiency in a Diesel Tractor.....	30
Figure 10: Wind Power Potential in Colorado.....	32
Figure 11: Increasing Competition for Water Resources Globally.....	37
Figure 12: Major Geologic Regions and River Basins.....	38
Figure 13: Irrigated Agricultural Land in Boulder County.....	39
Figure 14: Range of Field Efficiency for Irrigation Systems	41
Figure 15: Estimated Seasonal Water Requirement (consumptive use) in Longmont, CO (inches/season)	42
Figure 16: Root Zone Depth and Allowable Depletion Percentages for Various Crops'	43
Figure 17: Potential On-farm Conveyance Efficiencies	46
Figure 18: Potential Soil Erosion Due to Wind and Water in Boulder County	58
Figure 19: Potential Disadvantages of Cover Crops	66
Figure 20: Potential Advantages of Cover Crops	67
Figure 21: Average Biomass and Nitrogen Yields from Sample Legumes.....	68
Figure 22: Approximate Nutrient Content of Various Types of Manure at the Time of Land Application	71
Figure 23: Manure Application and Distribution Costs	71
Figure 24: Dollar Amount of Manufactured Inputs in Colorado	75
Figure 25: U.S. Ammonia Production Plants, 2005-06.....	78
Figure 26: Agencies Responsible for Regulating Genetically Engineered Organisms.....	83
Figure 27: External Costs of Pesticides.....	91
Figure 28: Percentages of U.S. 2005 Crop Acreage Planted to Insecticidal, Herbicidal, and Stacked-Gene Varieties.....	94
Figure 29: Summary of the Effects of Genetically Engineered Crops on Yields, Pesticide Use, and Returns	96
Figure 30: Tillage and Cover Crop Effect on Weed Production.....	100
Figure 31: Environmental Effects of Agroecosystem Management on the Biodiversity of Pests	105
Figure 32: Managing Biodiversity'	107
Figure 33: Summary of the Effects of Organic Farming on Individual Taxon, in Comparison to Conventional.....	110
Figure 34: Distribution of Farm Ownership by Age for Boulder County.....	115
Figure 35: Change in Farm Tenure from 1945 to 2007'	116
Figure 36: Comparison of Low-skilled Compensation Rates.....	117
Figure 37: Frequency of Non-Farm Work for Farm Operators in Boulder County.....	119
Figure 38: Common Fatal Injury Events Among Farm Workers.....	120
Figure 39: Associations Between Various Classes of Pesticide and Various Forms of Cancer.	123
Figure 40: Relative Likelihood of Unintended Genetic Effects	125
Figure 41: Methods for Genetically Altering Plants	126
Figure 42: Farm Size	130
Figure 43: Commodities Where Small Farms Have a Strong Market Presence	132
Figure 44: 2007 U.S. Organic Produce Output.....	138



List of Graphs

Graph 1: Average Precipitation and Temperature for Boulder County	11
Graph 2: Boulder County GHG Emissions by Sector, 1990-2012	17
Graph 3: U.S. Biofuel Production, 1990-2008	33
Graph 4: Identified Energy Balance of Corn Ethanol from Selected Studies	34
Graph 5: Nitrate Levels from Sampled Groundwater in the Front Range.....	51
Graph 6: Statewide Detection of Pesticides in Groundwater (Colorado).....	53
Graph 7: Common Causes of Soil Degradation on Agricultural Lands in the U.S.....	57
Graph 8: Irrigated Continuous Corn Grain Yields in Comparison to Nitrogen Fertilizer Rates for Conventional-till and No-till Farming, 2000-2004	61
Graph 9: Irrigated Continuous Corn Net Returns in Comparison to Nitrogen Fertilizer Rates for Conventional-till and No-till Farming, 2000-2005	61
Graph 10: Increasing Cost of Inputs in U.S. Agriculture	74
Graph 11: U.S. Commercial Fertilizer Use, 1965-2002	76
Graph 12: U.S. Ammonia Imports, Exports, and Net Imports.....	77
Graph 13: U.S. Nitrogen Supply from Domestic Production and Net Imports.....	77
Graph 14: Seed Expenditures' Share of Total Farm Expenditures	79
Graph 15: Overall Pesticide Usage 1964 to 2001	88
Graph 16: Most Common Insecticides in the U.S.....	89
Graph 17: Most Common Herbicides in the U.S.	89
Graph 18: Pesticide Use in Major Field Crops	92
Graph 19: Rate of Adoption for Genetically Engineered Crops in the U.S	93
Graph 20: Herbicide Use on Soybeans in the U.S.	95
Graph 21: Growth in Herbicide Resistant Biotypes	98
Graph 22: Number of Weeds with Evolved Glyphosate Resistance	99
Graph 23: Number of Honey Producing Colonies in the U.S. (Data were not available from 1982 to 1985)	109
Graph 24: Farm Employment (Full and Part-time), U.S. and Rockies Region, 1969 - 2000	113
Graph 25: Percent of Workforce in Poverty by Occupation.....	117
Graph 26: U.S. Unemployment Rates by Occupation in 2006	118
Graph 27: Average Farmer Household Income by Source from 1998-2004	118



Executive Summary

Agriculture lies at the heart of civilization. Modern agriculture seems in many ways to be the pinnacle of human achievement, enabling fewer farmers to continue to feed more of humanity than ever before. Uses of improved crop varieties, fertilizers, pest control, and irrigation have all helped to increase food security, yields, and economic growth. Despite increases in agricultural productivity per acre and per person, environmental, social, and economic problems have raised concerns about the sustainability of current agricultural production systems.

Sustainable agriculture recognizes the complex interactions between soil, water, plants, animals, climate, and people. The overarching goal of sustainable agriculture is to integrate all of these factors into a production system that is appropriate for the environment, people, and local economic conditions. UC Davis's Agricultural Sustainability Institute (ASI) is calling for sustainable food and agricultural systems that integrate environmental health, economic profitability, and social and economic fairness. ASI points to major efforts under way by farmers, extension educators, and researchers to develop and implement practices that are both more environmentally sound than conventional practices and, at the same time, more economically rewarding for farmers.

The literature review that follows discusses important research findings in this effort and highlights where each practice and system has limitations and opportunities. The findings are drawn from the studies conducted both in the Northern High Plains of Colorado and throughout the U.S. Over the past twenty years the quality and quantity of research on sustainable agriculture has increased, providing a body of data sufficient to help discern larger patterns and evaluate specific practices.

While the studies reviewed have provided valuable information, it is clear that research gaps still exist which new studies could help to address. While much remains to study and learn about sustainable agriculture – especially regarding specific impacts on profitability – the literature shows that sustainable agriculture can improve soil, protect water quality, enhance rural communities and ensure economic viability, though the extent of these impacts depends on the individual system.

A number of key drivers affect the sustainability of agriculture in Boulder County, including climate change, increasing competition for water resources, soil erosion, rising costs of energy, changing farm demographics, and increased market pressures. In order to review the broad themes and goals of sustainable agriculture, this literature review will consider specific strategies related to sustainable agriculture across key areas including *Climate, Energy, Water Use, Water Pollution, Soil Quality, Inputs, Pest Management, Biodiversity, Labor, Human Health, and Local Economy*.

Overview of Findings

Climate change has already begun to affect agricultural ecosystems across the Western U.S., directly impacting the types of crops that can be grown and indirectly impacting biodiversity and the prevalence of invasive species. As the climate continues to change, both positive and negative impacts are expected for agriculture in Boulder County. The challenge for agriculture will be to adapt to these changes fast enough to protect productivity while working to shift production practices to those that reduce greenhouse gas emissions from the agricultural system.



In Boulder County, demand and competition for water is expected to increase as the urban population continues to grow and as shifting climate impacts the regional water cycle. Currently, only a quarter of agricultural land is irrigated in the County, however, this is expected to increase even as water resources become increasingly limited due to climate changes. This will force agricultural systems to enhance the capture and utilization of precipitation, to reduce use or improve the efficiency of current irrigation methods.

In the past decade, the number of farms in the County has grown, with new operations demonstrating more diversified production, generally on smaller acreage. Additionally, the demographics of farm operators have shifted gradually to include more women operators, but have seen a continued increase in the average farm operator age. This increase in age reflects a changing pattern of employment with principal operators continuing to work well past standard retirement ages and younger generations seeking off-farm employment. Despite the growth in the market value of agriculture in the County and the addition of new operations, the majority of farm operators still have to work off the farm for a secondary income.

Sustainable production practices can help to increase the economic viability of farms. These practices involve a variety of approaches depending on site specific conditions, but key considerations include managing soil to enhance and protect quality, diversification of crops and livestock, and efficient use of inputs. The quality, yield, and viability of agricultural crops are directly dependent upon a healthy and fertile soil. Improving soil quality is considered to be a key element of a sustainable agriculture production system.

As farmers continue to take on the challenge of transforming agriculture, new agricultural technologies emerge, from simple infrastructure improvements to more complex biologic and genetic developments. Evaluation of these technologies for their potential to advance sustainable agriculture presents many challenges. Improving the linkages between the social, scientific, and environmental communities will better define the ways in which technological advances can benefit society and continue to advance sustainability.

Sustainable agriculture is not a prescribed set of specific practices, rather, it is an integrated system that considers a more complete account of both the costs and benefits of agriculture as it applies to environmental, social, and financial well-being. Recognizing there is no singular definition of sustainable agriculture, this literature review seeks to illustrate both the commonality and the controversy that arises when reviewing current sustainable agricultural practices and methodologies.

1. Climate

Summary

The climate in Boulder County determines to a great extent which crops can grow efficiently in the local agricultural ecosystem due to precipitation, temperature, and wind constraints. Overall, the climate in Boulder County is characterized by low annual precipitation, strong temperature variations, and periods of drought. Temperatures range from an average daily maximum of 64.3° F and average daily minimum of 38.2° F with extremes reaching -15° F to 115° F. The growing season averages about 140 days annually for Northeastern Colorado, with the average period of frost-free days occurring between May 3rd to October 2nd (Boulder) and May 8th to October 2nd (Longmont).

Without the presence of a large body of water nearby, precipitation is generally light with about 15-18 inches of rainfall annually. Of this precipitation, about seventy to eighty percent falls between the months of April and September. During lower precipitation years Boulder County is heavily dependent upon snowmelt from the Rocky Mountains to feed the local network of ditches, rivers, lakes, and reservoirs for both irrigation and power. The area has experienced eight periods of drought since 1930, with an average of one significant drought every 9.34 years.

Colorado is expected to see the affects of human induced climate change in the coming decades. In this report, the implications of climate change for agriculture are focused on two main areas; (1) the potential impacts to the local climate and weather patterns and the associated impacts to agriculture in the area and (2) the role of land use in mitigation efforts to reduce greenhouse gas (GHG) emissions and atmospheric concentrations of carbon.

Climate change has already begun to affect agricultural ecosystems across the Western U.S., directly impacting the types of crops that can be grown and indirectly impacting biodiversity and the prevalence of invasive species. The main impacts expected are an increase in both the average temperature and occurrence of extreme weather events (heat waves, intense hail, strong thunderstorms, etc.). Periods with decreased precipitation are also expected, which will likely increase competition with other sectors for water resources as well as reliance on the storage capacity of lakes and reservoirs.

As the climate continues to change, agriculture in Boulder County will experience both positive and negative impacts. For example, a low or gradual increase in the level of carbon dioxide (CO₂) and average temperature may bring a positive response in overall growth of crops, but will likely negatively impact the yields of crops such as corn, wheat, sorghum, and beans due to a shorter grain filling time. The challenge for agriculture will be to adapt to these changes fast enough to protect productivity, while working to shift production practices to reduce agricultural greenhouse gas emissions.

1.1 Climate of Northern High Plains Colorado

Boulder County is located in Northeastern Colorado, east of the Rocky Mountains. The region is semiarid with varying temperature and precipitation extremes throughout the winter and summer seasons.^{1, 2}

Key Characteristics of Boulder County's Climate:³

- Colorado's climate is generally dry and sunny.
- The State is semi-arid and averages about 15-18 inches of precipitation annually.
- Winters are dry, with wetter springs and summers.
- Weather conditions vary considerably with strong winds, thunderstorms, hail, and snow.

Daily as well as seasonal temperature changes can be significant. The average daily maximum temperature for Boulder County over the last 100 years is 64.3° F and the average minimum temperature is 38.2° F.⁴ The usual winter extremes in Northeastern Colorado can easily reach -15° F while summer highs can often exceed 100° F, reaching as high as 115° F.⁵

Due to the varied climate in Colorado, a highly diversified agricultural industry exists. The growing season for Boulder County, averages about 140 days a year, providing a long enough period for major crops like wheat, spring grains, corn, alfalfa, sugar beets, potatoes, and fruit to prosper.⁶ The average frost-free period occurs between May 3rd to October 2nd (Boulder) and May 8th to October 2nd (Longmont).⁷

As a result of Colorado's distance from major bodies of water (the Pacific Ocean and the Gulf of Mexico), precipitation is generally light. About 70-80 percent of Colorado's annual precipitation falls between the months of April and September.^{8, 9} Precipitation during the summer months comes largely from thunderstorms, which can be quite severe. Humidity is generally low, causing the area to favor rapid **evapotranspiration**, while the thin atmosphere allows for a greater penetration of solar radiation than lower elevation climates, increasing water demands from crops.¹⁰

One of the most important characteristics affecting the growing climate in the Northern High Plains is Colorado's unique topography.¹¹ The combination of Colorado's high elevation and mid-latitude interior continent geography results in a cool and dry climate. The prevailing air currents reach Colorado from westerly directions. Eastward-moving storms originating in the Pacific Ocean lose much of their moisture as rain or snow on mountaintops and westward-facing slopes. Boulder County receives relatively small amounts of precipitation from these storms, making the area heavily dependent upon snowmelt to feed rivers, lakes, and reservoirs for both irrigation and power.¹²

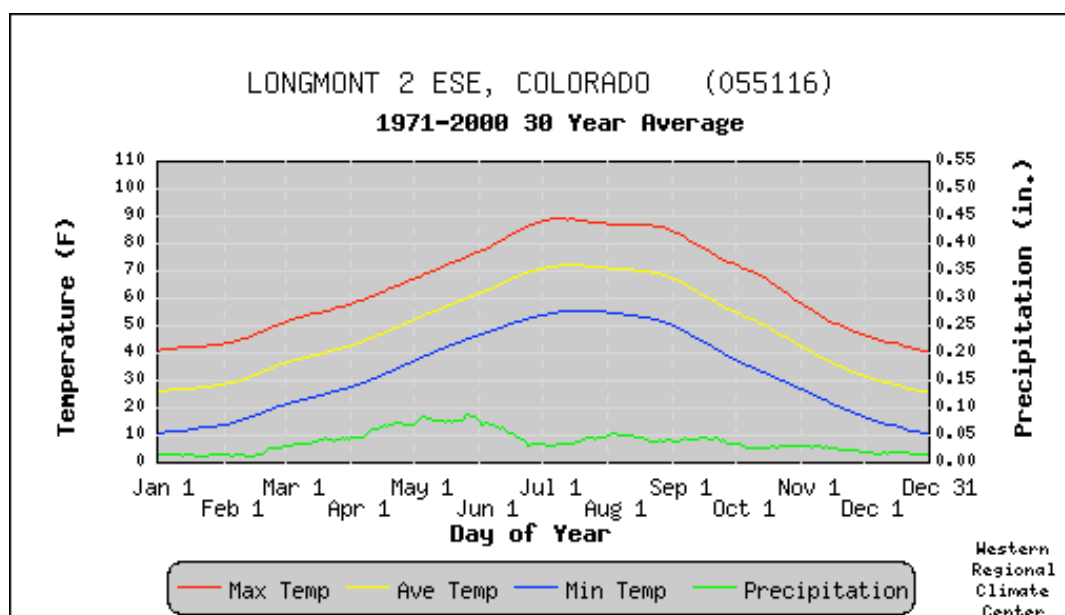
Graph 1: Average Precipitation and Temperature for Boulder County¹³

Max. Temp: average of all daily maximum temperatures recorded for the day of the year between the years 1971 and 2000.

Ave. Temp: average of all daily average temperatures recorded for the day of the year between the years 1971 and 2000.

Min. Temp: average of all daily minimum temperatures recorded for the day of the year between the years 1971 and 2000.

Precipitation: average of all daily total precipitation recorded for the day of the year between the years 1971 and 2000.

Several weather stations record climatic data across Boulder County. The variation of results amongst these stations is often minimal, with the highest potential for variation occurring at stations directly adjacent to the Front Range, which usually receive the highest precipitation rates. Graph 1 provides running averages of precipitation and temperature for Boulder County over a time horizon of 30 years, using the recording station in Longmont as an average for the County.¹⁴

Throughout Boulder County, rainfed or “dry farming” is practiced in non-irrigated areas with the principal crops being small grains (such as wheat and millet), sorghum, and corn. In wet years, excellent crop yields are realized with these farming practices, however the variation in precipitation from year to year can seriously affect production.¹⁵ Periodic droughts, which can extend from one or two to several years, create severe water supply and economic problems for all agricultural systems.

Irrigated agriculture helps to ensure adequate water for crops, however competition with users from other sectors can make irrigated agriculture difficult during times of decreased supply. Water supplies across the Colorado Front Range are becoming increasingly scarce as the population continues to grow.^{16, 17} For more information on water constraints, see section 3.1 *Supply and Demand*.

Figure 1: Precipitation Rates for Western U.S. 2009-2010

Precipitation (in)
12/1/2009 – 11/30/2010

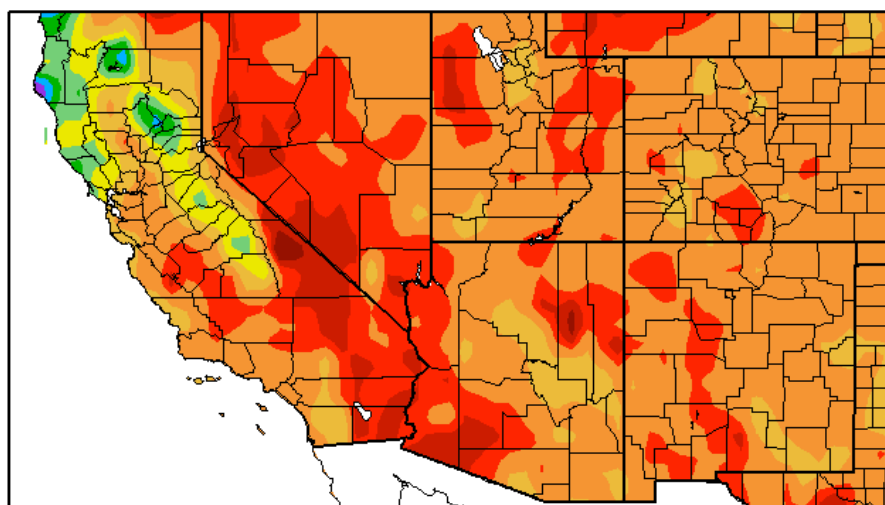

Generated 12/11/2010 at HPRCC using provisional data.

Regional Climate Centers

According to historical data, Boulder County has experienced eight periods of drought since 1930. This is an average of one drought every 9.34 years or a 10.67 percent chance of drought in any given year.¹⁸ Drought is likely to affect Boulder County in the future given its geographic location, semiarid conditions, and historical drought cycles.

Major periods of drought have included:¹⁹

- 1930-1937**—The drought of the 1930s had the greatest impact on the agricultural industry. Poor farming techniques, low market prices, and a depressed economy compounded the problem.
- 1951-1957**—Similar to the drought of the 1930s, the drought of the 1950s once again impacted the agricultural industry. Improvements in irrigation and farming techniques helped to mitigate the effects.
- 1976-1977**—This drought was characterized as a winter event, limited in duration. It was the driest winter in recorded history for much of Colorado's high country and western slope, severely impacting the ski industry.
- 1980-1981**—This drought, beginning in the fall of 1980 and lasting until the summer of 1981, also had costly impacts to the ski industry.
- 1994**—This growing season drought that impacted northeast Colorado was considered to be one of the driest years on record. Significant impacts included increased wildfires statewide, winter wheat crop losses, difficulties with livestock feeding, and declines in the state's fisheries.
- 1996**—On July 29, 1996, the Colorado governor issued a drought disaster emergency declaration. Fifteen counties were included in a request for U.S.

Department of Agriculture (USDA) assistance. Boulder County was not one of the 15 counties. Fall and winter precipitation alleviated further drought concerns.

- 2000**—Strong La Niña conditions created below average precipitation and above average temperatures for most months in 2000. An early snowmelt resulted in low stream flows, and by June, drought conditions began to affect most of the state.
- 2002**—The Colorado governor, for the first time in state history, asked the federal government to declare all of Colorado a drought disaster area. With an average temperature of 52.4° F, 2001 was the warmest year since 1986. The drought started in late 1999 and was compounded by scarce snowfall in 2001. The driest year on record for the Denver region and much of the state was 2002. Total precipitation for 2002 was 7.48 inches.
- 2002-2005**—Damage to trees as a result of early twenty-first century drought conditions resulted in pruning and removal costs for both parks and streets estimated at approximately \$122,660.

1.2 Potential Impacts of Climate Change

Throughout history, agricultural enterprises have coped with variances in climate through changes in management and in crop or animal selection, helping to ensure productivity and continued viability.²⁰ Already, climate change appears to be influencing both natural and managed ecosystems in Colorado and across the West.²¹ Future impacts for agricultural management are likely to be substantial, reflecting changing weather systems, temperatures, drought patterns, and biodiversity.

Potential impacts from climate change:²²

- Water supplies will become increasingly scarce, increasing competition, calling for trade-offs among competing uses, and potentially leading to conflict.
- Increasing temperature, drought, wildfire, and invasive species will accelerate transformation of the landscape.
- Increased frequency and altered timing of flooding will increase risks to people, ecosystems, and infrastructure.

Potential impacts from climate change are difficult to assess on a localized level due to a complexity of atmospheric and land interactions, local variables, and varying estimates of GHG concentration levels globally. Additionally climate change impacts can have both beneficial and detrimental impacts on plants and agricultural productivity, adding to the complexity of determining local estimates.^{23, 24} In response to elevated levels of carbon dioxide and low levels of warming many crops respond positively, but higher levels of warming negatively affect the growth and yield of crops.

Crop responses to a changing climate are generally affected by the interplay of three key factors: (1) rising temperatures, (2) changing water resources, and (3) increasing carbon dioxide concentrations. Generally, warming causes plants that are below their optimum temperatures to grow faster, increasing overall activity and productivity. This however is not always positive; for some crops, like cereal crops, warmer temperatures and faster growth means less time for the grain itself to grow and mature, reducing yields.^{25, 26} This grain filling period can be greatly shortened by even moderate temperature increases, decreasing the yields of corn, wheat, sorghum, and beans, among others.^{27, 28} This can be compensated for, in some annual crops, by planting earlier in the season to avoid potential late season heat waves and increased temperatures.²⁹

Recent climatic warming has been among the most rapid in the West and Southwest, occurring at a much higher rate than the global average in some areas. This increase in temperature has been driving declines and earlier melts in the spring snowpack, affecting both river flows and lake recharge. A number of papers have reported that the summer temperatures in Northeastern Colorado have been relatively stable, with only small increases in overall temperature compared to other areas in the West.^{30, 31} This may be due to the large amount of irrigated land that has replaced natural grasslands, which has led to increased soil moisture content in warm seasons and changes in the surface properties of the land (**albedo** and **aerodynamic roughness**).³² Boulder County has seen a lower overall increase in climatic warming and is expected to have a less severe decrease in precipitation (10-20 percent) than areas further to the West and South.^{33, 34, 35}



Water

Climate change will affect water in the agriculture sector in two ways: (1) crops may require more irrigation water to produce the same yields because of decreases in precipitation and the occurrence of drought and (2) water availability for irrigation could decrease significantly.³⁶ These two changes, coupled with increases in the average temperature, will signal a serious water supply challenge over the coming decades.^{37, 38}

In the Great Plains region of northeast Colorado, there was a 50 percent increase in irrigated acres between 1974 and 1980, which greatly increased the water demand in the region.³⁹ If water resources decrease due to climate change (Figure 2), water competition between agriculture and development will intensify. Consequently, water storage and management will become increasingly more important as the timing of snowmelt and irrigation water demand change.⁴⁰ More efficient irrigation and shifts in cropping patterns have the potential to compensate for decreases in water availability for irrigation due to rising temperatures, if done strategically.⁴¹

Figure 2: Projected Change in Spring Precipitation, 2080-2099⁴²

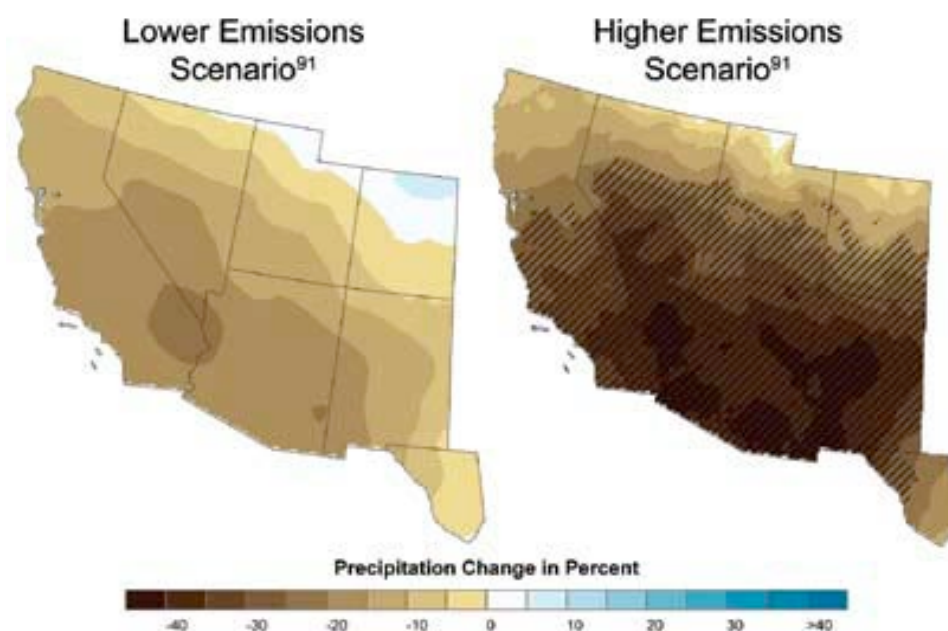

More information on water constraints can be found in section 3. *Water Use*.

Pests

Plant pests will most likely be affected by climate change due to rising temperatures and changes in regional precipitation. Plant pests include weeds, insects, fungi, viruses, and bacteria that cause plant diseases. A study published in the *New England Journal of Medicine* conducted on the impacts of climate change and human health found that an increase of pests and pathogens would be a likely outcome of climate change due to an imbalance in the agricultural ecosystem.⁴³ Weeds can benefit from climate change for several reasons. For example, some weeds may be favored because of an increase in soil moisture, or a decrease in soil moisture depending on more precipitation or drought during a given time period.⁴⁴ It is difficult to predict an accurate scope of the effects of climate change on weeds, but the crop-weed relationship will be altered.⁴⁵

Insect pests and pathogen life cycles will be affected by climate change in various ways. First, an increase in temperature for cumulative days could cause an increase in insect generations. Second, and most relevant in the temperate zones, is winter survival. For instance, if there are not enough consecutive days below a certain temperature, some insects will be able to continually regenerate. Third, certain populations of insects may shift regions of prevalence due to environmental change. A simulation was conducted on the European corn borer that predicted a shift of the species northwest up to 165 and 500 km for each 1° C rise in temperature.⁴⁶ The exact effects of climate change on the relationship between crops and pests are not yet certain, but it is known that their relationship will alter.

Depending on the degree to which climatic conditions are altered, the occurrence of plant fungal and bacterial pests could increase or decrease. As climate change begins to affect temperature, rainfall, humidity, and radiation, the spread of pathogens, as well as the resistance to pathogens from host plants, will change. Not including genetic modification of crops, there are several crop diseases that will be favored due to the occurrence of milder winters. Furthermore, warmer summers could provide a decrease in the prevalence of such diseases as the potato blight. Although this would be a positive outcome, there is a chance that overall prevalence of plant diseases will not decrease, but will instead move to regions with more favorable environmental conditions.⁴⁷

1.3 Agricultural Impacts to the Atmospheric Climate

Agriculture in Colorado contributes about nine percent of the State’s total greenhouse gas emissions, compared to a national average of about seven percent.⁴⁸ While agriculture in Colorado is a major contributor to GHG emissions, its impact in Boulder County is very low, representing only one to two percent of emissions (including methane emissions, manure management, and soil management) according to the latest *Boulder County, Colorado Greenhouse Gas Inventory*.⁴⁹ Additionally, the impact of agriculture on GHG emissions is not expected to increase significantly over the next few years as source emissions for soil management, manure management, and enteric fermentation are expected to remain near current levels.⁵⁰

Graph 2: Boulder County GHG Emissions by Sector, 1990-2012⁵¹

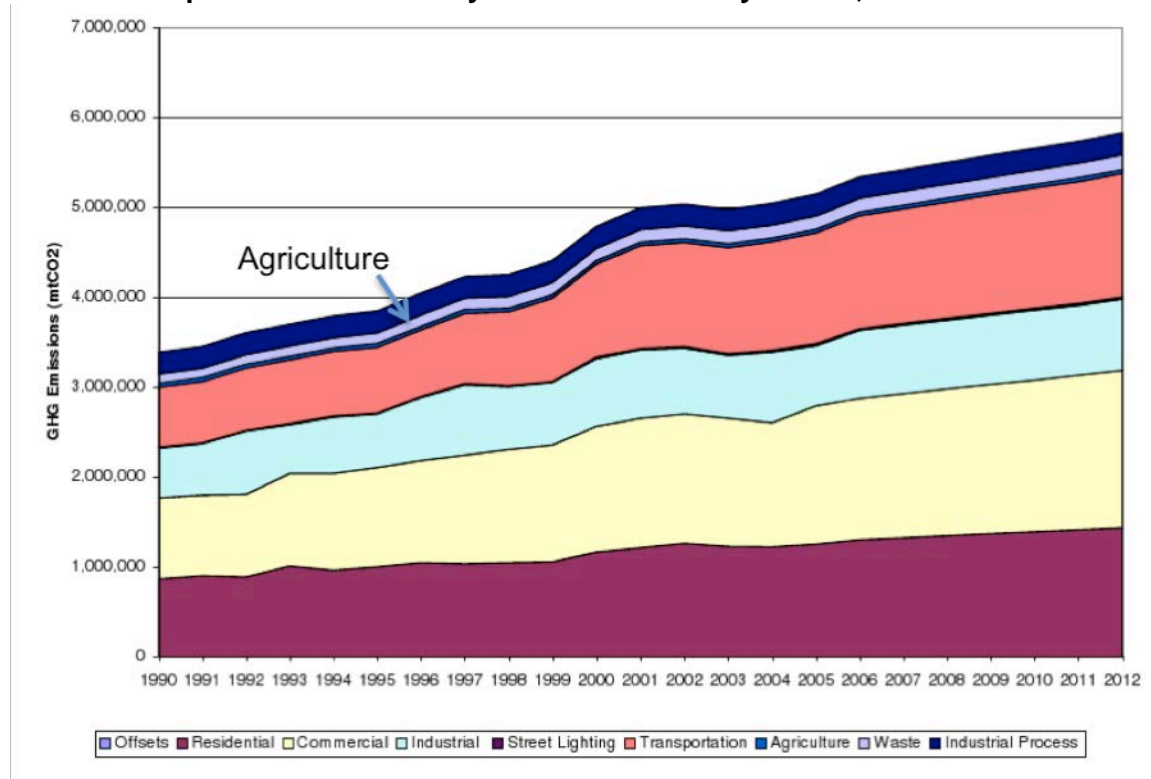

Boulder County has committed to reducing its carbon footprint and energy use as well as implementing sustainable forms of energy to run its daily operations. One example of this commitment is that, as reported by Boulder Weekly, Boulder County has set a goal to reduce total GHG emissions 11 percent below 1990 levels, by 2020.⁵² Compared to other emission sectors, notably commercial, residential and industrial, agricultural GHG emissions are significantly lower in the County. Despite the low overall percentage of GHG emissions represented by agriculture in the County, a reduction of four percent in agricultural emissions will be required for the county to meet its GHG reduction goals.⁵³

Figure 3: Historical and Forecast GHG Emissions for Boulder County by Sector (tCO₂e)⁵⁴

Sector	1990	1995	2000	2005	2012
Residential	877,863	1,012,283	1,208,808	1,304,999	<i>1,493,188</i>
Commercial	899,503	1,109,902	1,514,794	1,591,317	<i>1,945,865</i>
Industrial	548,918	589,204	639,346	542,752	<i>623,767</i>
Transportation	670,278	733,264	1,031,795	1,232,318	<i>1,375,003</i>
Agriculture	42,233	42,233	41,508	41,025	<i>41,025</i>
Industrial Process	244,204	244,204	244,204	244,204	<i>244,204</i>
Street Lighting	12,200	10,296	15,118	19,855	<i>21,971</i>
Waste	104,483	119,916	134,919	147,328	<i>164,906</i>
Offsets	(12,459)	(14,814)	(46,390)	(56,349)	<i>(58,775)</i>
Grand Total	3,387,223	3,846,488	4,784,101	5,067,448	<i>5,851,154</i>

Note – italics indicates forecast

The largest source of GHG emissions for most crop systems comes from nitrous oxide (N₂O) emissions from fertilized soils (Figure 4),^{55, 56} with additional emissions coming from irrigation, on-farm energy use, and manure sources, with each of these varying in their net emissions depending on the system.^{57, 58} The relative contributions of GHG emissions generated from global on-farm agricultural practices, not including contributions from transportation, are presented in Figure 4.

Figure 4: Global GHG Emissions of Agricultural Practices⁵⁹

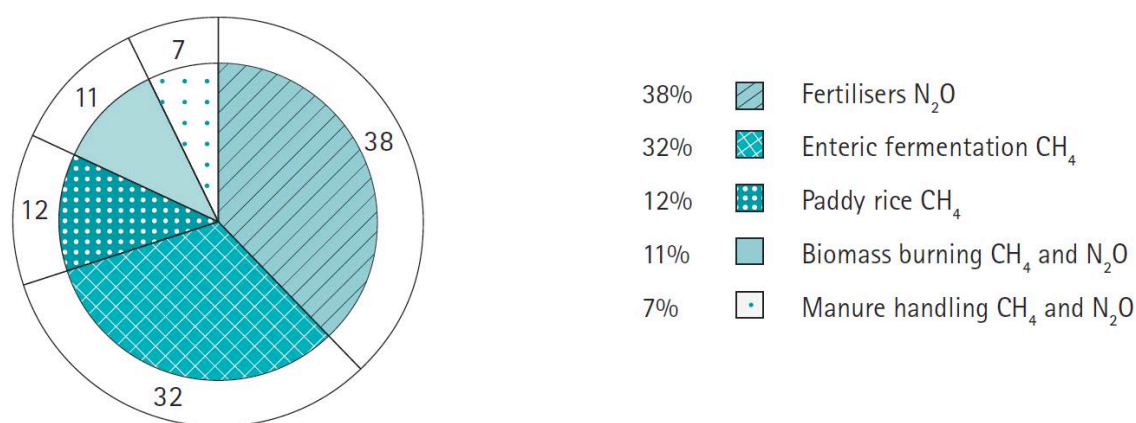

Note: CH₄ - methane; N₂O - nitrous oxide; and CO₂ - carbon dioxide.

1.4 Mitigation and Sequestration of GHG Emissions in Agriculture

Nationally, annual GHG emissions from agriculture are expected to increase in the coming decades due to escalating demands for food and shifts in diet.⁶⁰ However, improved management practices and emerging technologies may permit a reduction in emissions per unit of food (or of protein) produced. Agriculture can play an important role in helping to mitigate GHG emissions due to its ability to implement management changes rapidly relative to other GHG mitigation or carbon sequestration technologies.⁶¹ Many mitigation opportunities use current technologies and can be implemented immediately, but technological development will be a key driver to ensuring the efficacy of additional mitigation measures in the future.⁶²

GHG mitigation opportunities fall into two broad categories, based on the implemented mechanism of (1) Reducing Emissions and (2) Enhancing Removals.⁶³

Reducing Emissions

The primary GHG emissions produced by agricultural practices are carbon dioxide (CO₂), methane (CH₄), and nitrous oxide (N₂O).^{64, 65, 66} Through efficient management of carbon and nitrogen flows, reduction of these gases can be efficiently achieved in agricultural systems. Fertilization practices that deliver nitrogen more efficiently can reduce N₂O emissions⁶⁷ and better management of livestock feed and manure can reduce the amount of CH₄ produced.⁶⁸ Approaches to reduce GHG emissions vary by region depending on local conditions, however, the most prominent options for mitigating GHG emissions in agricultural operations in Boulder County include improved land management (through nutrient use, agronomy, and tillage), improved feeding practices, and manure management.⁶⁹ A more complete list of potential mitigation measures is presented in Figure 5 on the following page.

In order to understand the global warming potential (GWP) of an approach or practice it is important to view the whole system. Often times a mitigation practice will affect more than one gas, sometimes in opposite ways by reducing one gas but increasing another, so the total reduction benefit depends on the combined effects of all greenhouse gases.^{70, 71} Additionally, the timeframe of emission reduction is important to consider, as some emissions are reduced indefinitely while others may be only reduced temporarily.^{72, 73}

Figure 5: Potential Measures for Mitigating GHG Emissions from Agricultural Land and Operations.

Adapted from the IPCC Fourth Assessment Report and Smith et al., 2007a⁷⁴

Measure	Examples	Mitigative effects ^a			Net mitigation ^b (confidence)	
		CO ₂	CH ₄	N ₂ O	Agreement	Evidence
Cropland management	Agronomy	+		+/-	***	**
	Nutrient management	+		+	***	**
	Tillage/residue management	+		+/-	**	**
	Water management (irrigation, drainage)	+/-		+	*	*
	Rice management	+/-	+	+/-	**	**
	Agro-forestry	+		+/-	***	*
	Set-aside, land-use change	+	+	+	***	***
Grazing land management/ pasture improvement	Grazing intensity	+/-	+/-	+/-	*	*
	Increased productivity (e.g., fertilization)	+		+/-	**	*
	Nutrient management	+		+/-	**	**
	Fire management	+	+	+/-	*	*
	Species introduction (including legumes)	+		+/-	*	**
Management of organic soils	Avoid drainage of wetlands	+	-	+/-	**	**
Restoration of degraded lands	Erosion control, organic amendments, nutrient amendments	+		+/-	***	**
Livestock management	Improved feeding practices		+	+	***	***
	Specific agents and dietary additives		+		**	***
	Longer term structural and management changes and animal breeding		+	+	**	*
Manure/biosolid management	Improved storage and handling		+	+/-	***	**
	Anaerobic digestion		+	+/-	***	*
	More efficient use as nutrient source	+		+	***	**
Bio-energy	Energy crops, solid, liquid, biogas, residues	+	+/-	+/-	***	**

Notes:

a: + Denotes reduced emissions or enhanced removal (positive mitigative effect)
 - Denotes increased emissions or suppressed removal (negative mitigative effect)
 +/- Denotes uncertain or variable response.

b: A qualitative estimate of the confidence in describing the proposed practice as a measure for reducing net emissions of greenhouse gases, expressed as CO₂-eq: Agreement refers to the relative degree of consensus in the literature (the more asterisks, the higher the agreement); Evidence refers to the relative amount of data in support of the proposed effect (the more asterisks, the more evidence).

Nutrient Management

In most cropping systems, applied nitrogen from fertilizers, manures, **biosolids**, and other sources is not always used effectively by crops. Excess or unused nitrogen in the soil is very susceptible⁷⁵ to forming and emitting N₂O, a GHG that is 310 times stronger than CO₂.^{76, 77} It is important to note that all forms of nitrogen applications can contribute to nitrogen losses and N₂O emissions. By improving the nitrogen use efficiency in crops, N₂O emissions and GHG emissions from nitrogen fertilizer manufacture can be significantly reduced.⁷⁸ Specific practices that improve nitrogen use efficiency and help to reduce leaching or nitrogen emissions include:^{79, 80, 81, 82, 83}

- Adjusting application rates based on precise estimation of crop needs (e.g., **precision agriculture**)
- Using slow- or controlled-release fertilizer forms of nitrification inhibitors (which slow the microbial processes leading to N₂O formation)
- Applying nitrogen when least susceptible to loss, often just prior to plant uptake (improved timing)
- Placing the nitrogen more precisely into the soil to make it more accessible to crops' roots
- Avoiding nitrogen applications in excess of immediate plant requirements

For more information on nitrogen fertilizers, see sections *4.3 Fertilizers as Water Pollutants* and *6.2 Fertilizers*.

Enhancing Removals - Agronomy

Increasing yields and generating higher inputs of carbon residue through improved agronomic practices help to increase the amount of carbon sequestered in soil.^{84, 85} Practices like improving crop varieties, extending crop rotations (especially those with perennial crops), and minimizing bare and fallow land help keep more carbon below ground and out of the atmosphere.^{86, 87, 88, 89} Adding more nutrients when the soil is deficient can help promote soil carbon gains⁹⁰ by increasing productivity, however, when these benefits are achieved through synthetic nitrogen fertilizer applications they can be offset by higher N₂O emissions from soils and CO₂ emissions during the synthetic fertilizer manufacture process.^{91, 92, 93} The manufacture of synthetically derived inputs like fertilizers and pesticides produce carbon emissions due to the use of fossil fuels to produce, manufacture, and transport synthetic inputs.

While the climate impact of synthetic fertilizers and pesticides is well documented in the literature, the climate impact of organic fertilizers and pesticides is not well documented and is an area where additional research is needed.⁹⁴ The climate impact of organic inputs is not zero since organic fertilizers have a number of energy requirements, which are discussed further in section *2.1 Breakdown of Energy Use*. There are also energy and climate impacts from the production, transportation, and application of organic pesticides. A study evaluating the environmental impact of organic and synthetic pesticides found that organic pest management practices are not necessarily more environmentally sustainable than conventional ones in regards to environmental impact. The authors concluded that in order to optimize environmental sustainability, individual tactics can be evaluated for their environmental impact in the context of an integrated approach.⁹⁵

A reduction in the use of synthetically derived fertilizers and inputs can effectively lower emissions and increase the sequestration and storage of carbon in soils.⁹⁶ One of the most applicable examples to Boulder County is the use of rotations with legume crops,⁹⁷ that help to reduce reliance on external nitrogen inputs, though even legumes have been shown to increase N₂O in some locations, negating some of the potential climate benefits.⁹⁸ Additionally, the use of catch or **cover crops** provide temporary vegetative cover between successive agricultural crops, or between rows, helping to sequester carbon from the atmosphere and reduce N₂O emission by extracting unused plant available nitrogen from the preceding crop.^{99, 100}

The global warming potential of organic farming systems is considered to be smaller than that of conventional systems when calculated per land area, but this difference declines, when calculated per product unit based on comparative yields.¹⁰¹ While practices like cover crops, manure application, and conservation tillage can help to reduce GHG emissions from synthetic fertilizers, there are additional increases in GHG emissions from manure handling, compaction of soils resulting from the use of heavy machinery, and in some instances increased fuel use.¹⁰²

Enhancing Removals - Tillage and Residue Management

Due to advances in weed control methods and farm machinery, many crops can now be grown with conservation tillage. Since soil disturbance tends to stimulate soil carbon losses through enhanced decomposition and erosion,¹⁰³ reduced- or no-till agricultural practices often result in a gain of carbon to the soil, but not in all systems.^{104, 105, 106} The conversion of agricultural systems from continuous tillage (conventional tillage) to minimal tillage could increase carbon storage in soils in Boulder County, lowering net GHG emissions,^{107, 108, 109} but producers are unlikely to make the conversion to minimal tillage systems unless they are demonstrated as profitable. These limited tillage practices are increasingly being used across cropping systems in a wide range of locations, but have not seen wider-spread adoption due to concerns over potential financial benefits.^{110, 111}

Many studies have assessed the viability of no-till systems,^{112, 113} but few of these studies have looked at no-till agriculture on irrigated lands, raising concerns over inferring financial impacts from non-irrigated to irrigated lands.^{114, 115, 116} Additionally, due to the location specific impacts of low tillage practices on carbon sequestration, it is important to focus on research conducted in a regionally appropriate area to Boulder County. A five-year study¹¹⁷ conducted just outside of Fort Collins, CO, gives a detailed assessment of potential impacts from adoption of limited tillage practices on irrigated land. Results from the study found that conversion of agricultural systems from continuous tillage to no-tillage systems may lower the overall GHG impact and improve net financial returns by avoiding over application of nitrogen fertilizer. Specifically, the study found that

by switching from conventional tillage continuous corn to no-till corn–bean farmers would increase annual average net returns by \$228 per hectare while reducing annual net GWP by 929 kg CO₂ equivalents per hectare.¹¹⁸

Adopting reduced or limited tillage practices may also affect N₂O emissions but the net effects are not well-quantified across different agricultural systems, climatic conditions, and soil types.^{119, 120, 121} Reviewed literature relevant to the agricultural ecosystem in Boulder County showed that overall there is a net decrease in N₂O emissions associated with minimal tillage practices.^{122, 123, 124} While this seems to be the case in Boulder County, it is important to note that in other areas nationally, reduced tillage may increase N₂O emissions, while elsewhere it may have no measurable influence.¹²⁵

While the majority of the scientific community sees the potential of no-till agriculture and organic farming methods to sequester more carbon, there have been some objections raised about the longevity of the benefits. Of particular concern is the depth at which the carbon is preserved, as the majority of studies have only measured soil organic carbon in the top 20 centimeters (cm) of the soil profile. A study reviewing 11 different soils across the United States found carbon sequestration in the top 20 cm, but did not find significant carbon reserves below that 20 cm profile.¹²⁶ This means that if that soil were to be tilled again, most of the sequestered carbon would be released, negating potential benefits. More research is being conducted on soil carbon sequestration to determine at what depth carbon is stored. It is likely that carbon, like topsoil, can be accumulated at greater and greater depths as more material is applied, however, this is an area for further research.

2. Energy

Summary

While the types of farm operations can vary significantly, and with it their energy use, the relative consumption of energy by practice has been shown to be fairly consistent. Overall, the largest energy use in agriculture is the production, manufacture, and transport of synthetic fertilizers (29 percent of consumption), followed by the use of diesel fuel (27 percent), and then electricity (21 percent).

Since the late 1970s, the total use of energy in agriculture has fallen by about 28 percent as a result of efficiency gains related to improved machinery, equipment, and production practices. While the overall consumption of energy has decreased over the last 40 years, the consumption of electricity and diesel has increased, and fertilizer and pesticide energy consumption have increased only slightly.

Synthetic fertilizer production is closely linked with both the supply and price of natural gas since natural gas accounts for 75-90 percent of the costs of production for nitrogen fertilizer. This connection makes farmers susceptible to price volatility for natural gas in the market and many farmers have been shown to be increasingly price sensitive to fertilizer costs. In addition to fertilizers, pesticides represent about six percent of the energy use on farms and face many of the same issues as fertilizers regarding links to fossil fuel prices and costs to farmers.

Strategies identified in the literature for reducing energy consumption on farms include reducing the use of synthetic fertilizers through the use of manures, utilizing conservation tillage practices, improving irrigation efficiency, and evaluating opportunities for generating energy within agricultural systems. With each of these strategies there are potential tradeoffs related to both energy use and profitability. One practice may decrease one type of energy use, like synthetic nitrogen fertilizers (reducing costs and environmental impact), but increase others, like fuel use (increasing environmental impact) and labor (increasing costs). Additional research evaluating both the direct and indirect impacts of these strategies on reducing energy use is needed to be able to make a fully informed assessment.

Irrigation was identified as a quick improvement area for energy efficiency. It is estimated that most pump systems waste about 25 percent of electricity due to poor design and system inefficiencies. Pumps powered by diesel use 40 percent more fuel than they would if properly sized, adjusted, and maintained. Importantly, these improvements correspond directly with a financial reward for farmers due to decreased irrigation costs. In 2008, energy expenditures for irrigation systems in Colorado represented about \$78 million, with an average cost of \$36 per irrigated acre for surface water and \$55 per irrigated acre for groundwater, not including repair and maintenance.

The emerging role of agriculture as a producer of energy is widely discussed in the literature, however, it is difficult to evaluate the economic viability of energy generation on farms due to a variety of factors such as site location, financial rebates, and system requirements. Energy production from farm-based operations has grown rapidly in recent years, yet it still remains a small fraction (less than one percent) of national energy needs. According to the 2007 Agriculture Census, there are 31 farm operations in Boulder County that have installed renewable energy production systems. The majority of energy production growth has come from increased renewable energy capacity (primarily from biofuels and wind), but this growth has relied heavily on federal and state programs and incentives.

2.1 Breakdown of Energy Use

Energy is an important input for agricultural production. The U.S. food system comprises approximately 16-19 percent of the total U.S. fossil fuel consumption, agricultural production is responsible for nearly half of this demand.^{127, 128} While agriculture represents a large percentage of fossil fuel consumption nationally, agriculture's share of total U.S. direct energy consumption is low at about one percent of national energy consumption.¹²⁹

Direct energy consumption includes fuel or electricity to heat or cool buildings, to operate machinery and equipment, for lighting on the farm. Indirect energy includes energy not used directly on the farm, for example, energy used to produce fertilizers and chemicals off the farm.¹³⁰ Energy uses vary depending on the types of crops grown, climate, and various land management practices, however, all farming practices have relatively consistent energy demands. The largest energy use in agriculture is the production, manufacture, and transport of synthetic fertilizers. A study of 2002 farm use data found that direct energy accounts for 5-7 percent of farm expenditures. When combined with indirect forms of energy, which account for another 9-10 percent of farm expenditures, total energy cost per dollar of expenditure is 14-17 percent.¹³¹ The fuel and oil used by farm tractors account for less than one third of the total energy consumed on the farm, while fertilizers and pesticides account for about 35 percent of total agriculture energy consumption.¹³²

Figure 6 provides an illustrative breakdown of typical energy uses shown by percentage of total energy consumption.^{133, 134}

Figure 6: Farm Energy Use by Source¹³⁵

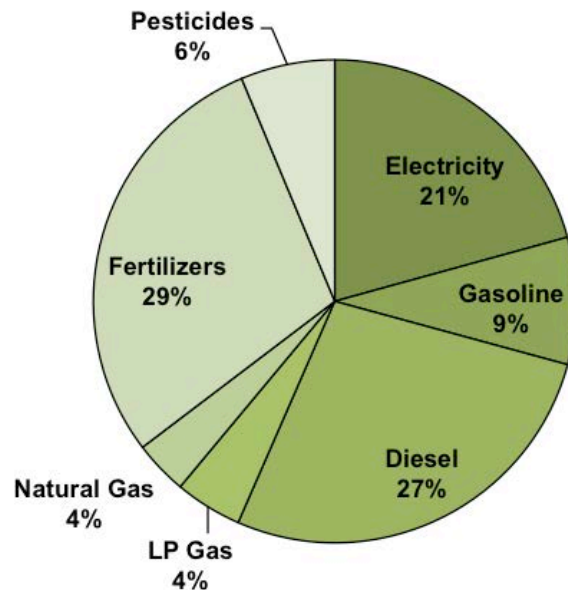

All agricultural systems are dependent on fossil and solar energy and in many respects energy use does not differ between systems. The energy cost of transporting grain to market is the same per mile, the cost of pumping irrigation water is the same cost per acre-foot, the same amount of energy is needed to manufacture and run machinery, and the indirect energy in seed or livestock breeding differs little.¹³⁶

The largest difference between energy use in conventional and organic systems is associated with the use of pesticides and nitrogen based fertilizers. A number of studies have shown that the application of any synthetic nitrogen fertilizer reduces energy efficiency when compared to systems that use manure or legumes as a primary nitrogen source.^{137, 138, 139, 140} The Food and Agriculture Organization of the United Nations notes that:

“On either conventional or organic farms, when animals produce some or all of the fertilizer needed for crop production, the energy expenditures are greatly reduced. Because of its reliance on natural fertilizers, **organic agriculture** often performs relatively better in terms of energy efficiency (measured as the ratio of energy input per unit of crop output) despite lower yields.”¹⁴¹

A study conducted by the USDA on the energy balance of using different growing practices for corn to produce ethanol found that crop yields were 20 percent lower in the organic system, but inputs of fertilizer and energy use were reduced by 34-53 percent and pesticide inputs were reduced by 97 percent.¹⁴² Similar results were found in a comparative study, conducted in Canada of two crop rotations (wheat-pea-wheat-flax and wheat-alfalfa-alfalfa-flax) cultivated organically and conventionally, which concluded that the energy use was 50 percent lower with organic than with conventional management. Despite the yields being as high as 30 percent less under organic management, the energy efficiency (energy produced /energy used) remained higher in the organic systems.¹⁴³

There is debate in the literature reviewed as to the extent that organic practices reduce energy use across crop varieties and other related energy inputs like labor and fuel use. Various studies conducted on organic carrot and potato production have cited an increase in energy inputs (diesel fuel) per unit of output because of increased mechanical weeding and cultivation.^{144, 145, 146} Additionally, systems utilizing manure and legumes often require an increase in labor inputs. Results published from studies conducted by *The Organic Center* showed that an organic corn system compared to a conventional corn system, had 31 percent lower energy use, but a 32 percent increase in labor inputs.¹⁴⁷ These tradeoffs between decreasing one type of energy use like synthetic nitrogen fertilizers, but increasing others like mechanical (tractor and fuel use) and labor, are difficult to evaluate, so they are best evaluated on a per system level.

Efficiency Gains in Farm Energy Use

U.S. farm production has become increasingly mechanized, requiring timely energy supplies at particular stages of the production cycle to achieve optimum yields. Since the late 1970's, the total use of energy in agriculture has fallen by about 28 percent as a result of efficiency gains related to improved machinery, equipment, and production practices.¹⁴⁸ Over the last 40 years, though total U.S. electricity and diesel use by farms has grown dramatically, fertilizer and pesticide use has increased only slightly, with a decline since 1980, and gasoline use has sharply declined.¹⁴⁹ Importantly, the declines in energy use since the 1970's have not come at the expense of lower output, as referenced in Figure 7, instead, agricultural producers have been able to increase their energy efficiency while maintaining or increasing production levels.¹⁵⁰

Figure 7: Direct Energy Use (DEU) and Agricultural Output (productivity per acre) 1965-1999¹⁵¹

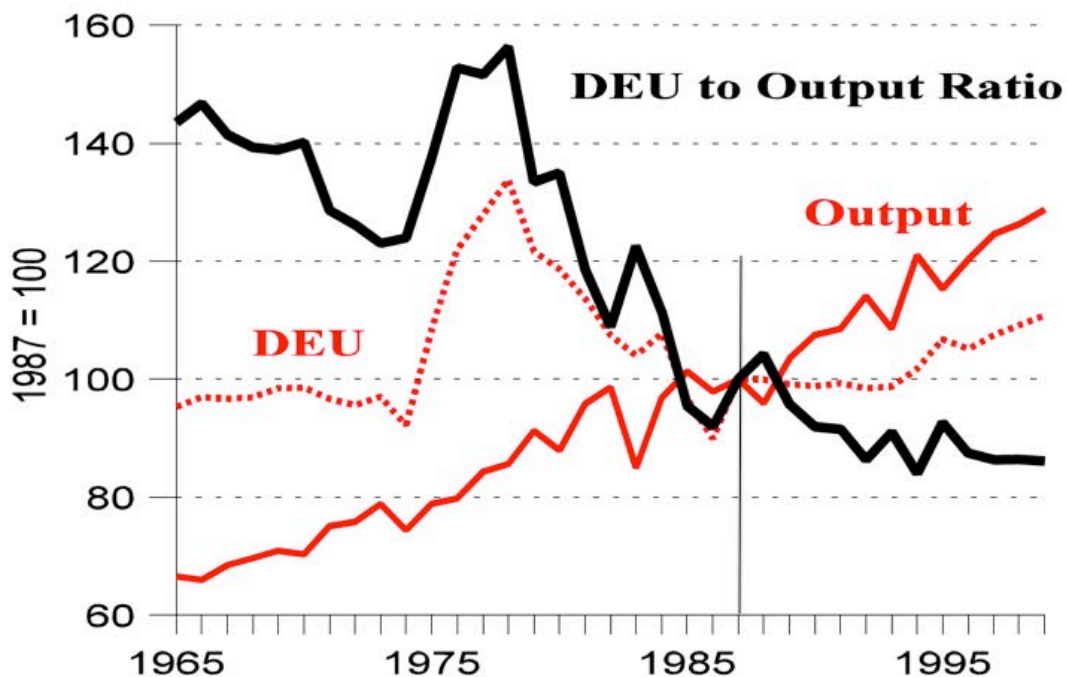

Fertilizer and Pesticide Use

Over a third of all energy used in U.S. agriculture goes to commercial fertilizer and pesticide production.¹⁵² The production of both fertilizers and pesticides uses about two percent of all the energy used in industrial processes.¹⁵³ Fertilizer production is closely linked with both the supply and price of natural gas, as natural gas accounts for 75-90 percent of the costs of production for nitrogen fertilizers. Natural gas is the key ingredient in the production of anhydrous ammonia and for the further manufacture of urea, ammonium nitrate, and other nitrogen solutions.¹⁵⁴ Figure 8, illustrates that as the price of natural gas increases, so does the cost of synthetic nitrogen fertilizers for farmers.



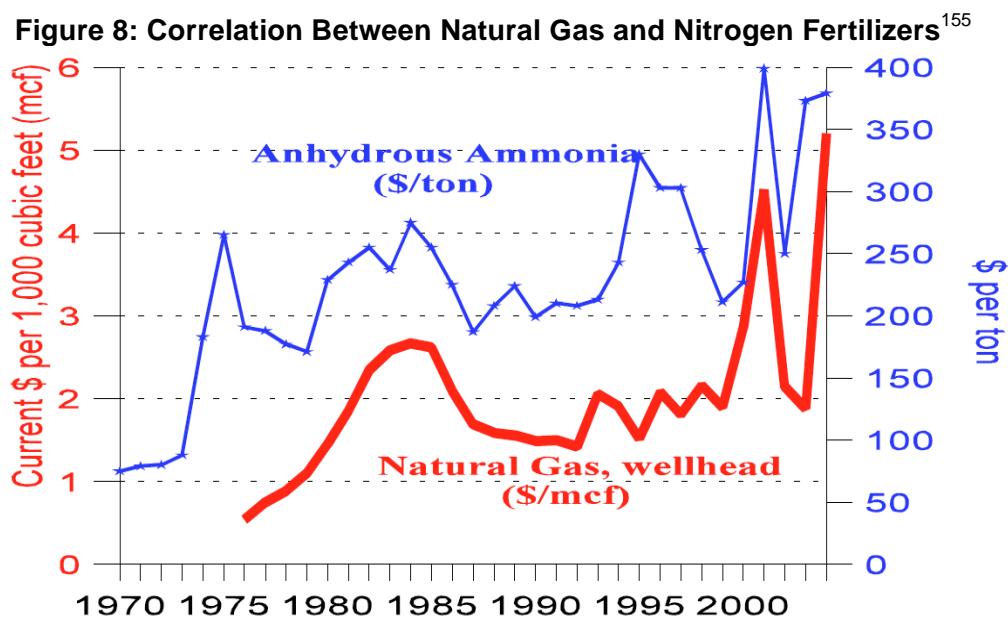

Higher costs of fertilizers generally elicit two responses from cost-sensitive farmers: (1) fertilizer is applied at lower application rates to crops, or (2) crops that are less dependent on fertilizer are planted.¹⁵⁶ It has been shown that when farmers are able to reduce the need for synthetic fertilizer inputs, while maintaining field productivity, they are more resistant to volatile energy prices and more profitable. Additionally, precision agriculture has been cited as a potential method of increasing the energy efficiency of applying synthetic nitrogen fertilizer, but energy use in these systems requires further research to identify the potential ranges for improvements.¹⁵⁷ For further information on fertilizers, please see 6. *Inputs*.

As with synthetic fertilizers, synthetic pesticides require fossil fuels for production, manufacture, and transport. Pesticides represent about six percent of the energy use on farms and face many of the same issues as fertilizers regarding links to fossil fuel prices and costs to farmers.¹⁵⁸ Inorganic fertilizers typically consume large sums of energy mostly due to the necessary inputs of natural gas, but energy requirements are also a major input for organic fertilizers. A report conducted on the *Energy Efficiency in Fertilizer Production and Use* found that “transportation and application energy demands (fuel use) are often higher for organic fertilizers since they are less nutritious per unit weight.” The report highlighted additional energy requirements for processed organic fertilizers, which can include:¹⁵⁹

- Collection of organic waste
- Loading and transportation of waste to a processing plant
- Unloading and putting waste into **windrows**
- Turning and irrigation of windrows to expedite composting
- Collection, loading, and transportation of composted waste from processing plant to field
- Unloading waste for storage
- Loading and applying waste to field by farm equipment

Each of these variables contributes to the overall energy required to produce, transport, and apply organic fertilizer. The more a fertilizer is processed, the higher its energy requirements will be. At a certain level of processing and transportation, organic fertilizers could require more energy to produce than the equivalent synthetic fertilizer.¹⁶⁰ Direct comparisons of the energy use embedded in different types of fertilizers is an area where additional research is needed, as current data is often too generalized to draw distinct conclusions.

Irrigation

In 2008, there were 1,688,124 million pump-irrigated acres in Colorado, according to the United States Department of Agriculture's (USDA) 2008 Farm and Ranch Irrigation Survey. Energy costs for these systems averaged \$78,122,000, or \$36 per irrigated acre for surface water and \$55 per irrigated acre for groundwater. Farms spent an additional \$12 per acre, on average, to maintain and repair irrigation equipment. The main types of energy used for pumping systems were electricity, natural gas, and diesel.¹⁶¹

A number of studies have highlighted that the majority of irrigation systems are not as energy and water efficient as they should be. A study conducted in Colorado, Wyoming, Nebraska, and other states, by Colorado State University, found that on average, about 25 percent of the electrical energy used for irrigation was being wasted due to poor pump and motor efficiency.¹⁶² A study conducted by Kansas State University found that irrigation systems, on average, use about 40 percent more fuel than they would when properly sized, adjusted, and maintained.¹⁶³

The most common causes of wasted energy in irrigation systems are:¹⁶⁴

- The lack of system maintenance
- The wrong pump for the system
- Pump wear from **cavitation** or abrasion
- Improperly sized or designed fittings
- Water source changes

A new pump and high efficiency motor have been found to increase pumping system efficiencies by 20 percent.¹⁶⁵ A study conducted by Pacific Gas and Electric (PG&E) and American Society of Heating, Refrigeration, and Air-Conditioning Engineers (ASHRAE) in California found that the single greatest contributor to pump inefficiency was an oversized pump. If a new pump is selected based on future needs, such as degraded (scaled) pipes or a higher projected flow to meet increased crop requirements, it will deliver excess fluid at a higher head than necessary.¹⁶⁶ For example, the California Energy Commission reports that vegetable farmers can save more than 25 percent of water pumping, fertilizer, and herbicide costs with subsurface drip irrigation technologies.¹⁶⁷ Improperly designed systems not only waste energy but can lead to crop stress, reduced yields, wasted water, runoff, soil erosion, and many other problems.¹⁶⁸ For more information on irrigation practices see *Water Use*.

Fuel Use

Diesel and gasoline use are responsible for approximately 36 percent of the total energy use on farms, representing a significant financial cost for farmers. The increased volatility of fuel prices can make it difficult for farmers to estimate future costs of fuel, making practices that reduce fuel use and improve vehicle efficiency useful ways to lower costs.¹⁶⁹ Economic studies have attempted to measure year-to-year producer responsiveness to changes in fuel prices, suggesting that a 10 percent rise in fuel prices is associated with about a six percent decline in use.¹⁷⁰

Ways to reduce fuel use include switching from gasoline-powered to more fuel-efficient diesel-powered engines, adopting conservation tillage practices (which tend to use less mechanical energy), and changing to larger multifunction machines.¹⁷¹ Additional methods to improve tractor and vehicle fuel use efficiency are highlighted in Figure 9.

The following are ways to improve on-farm vehicle efficiency:¹⁷²

- Decrease fuel consumption by 20 percent by gearing up and throttling down tractors
- Correctly match the load weight to the pull of the tractor
- Reduce fuel usage by up to 10 percent by avoiding idling
- Perform multiple tasks at once to save tractor-driving time
- Service tractors on a regular basis

Figure 9: Factors Reducing Fuel Efficiency in a Diesel Tractor¹⁷³

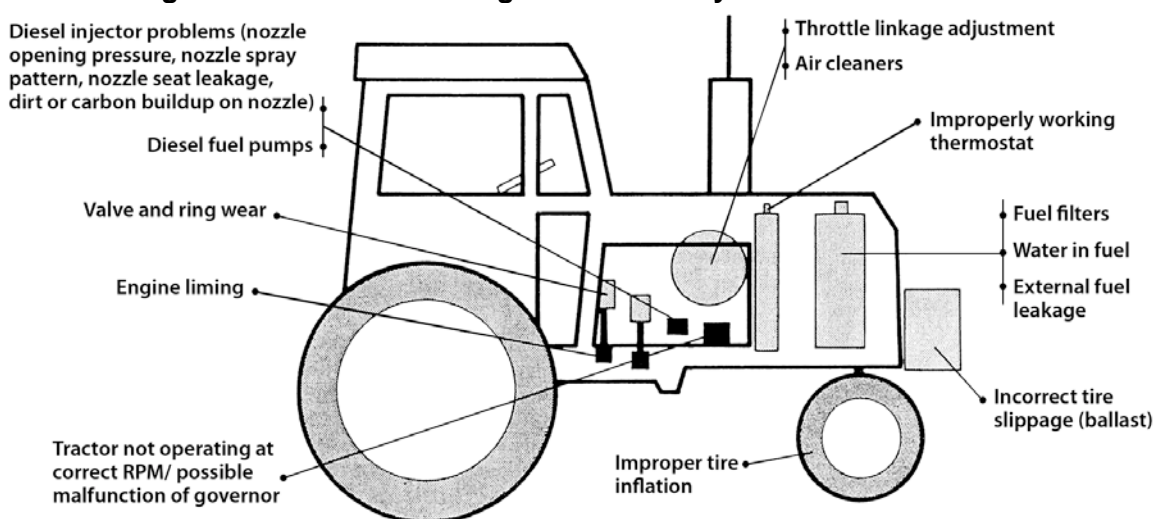

Crop production traditionally requires several passes over the field, with tractors and equipment involved with field preparation, planting, cultivation, fertilizer and chemical applications, or harvesting. Fuel consumption depends on the fuel efficiency of the particular machine involved, the number of passes over the field (determined largely by the tillage practice employed), and the size of the field.¹⁷⁴ Fuel reductions in tractor and equipment use can be achieved by replacing tilling operations with reduced- or no-till practices. Replacing tillage operations with no-till practices can save at least 3.5 gallons of fuel per acre according to the Natural Resource Conservation Service of the USDA.¹⁷⁵ While conservation tillage practices can help to decrease direct energy inputs like fuel use, they may increase **indirect energy use** by requiring additional pesticides and fertilizers. Because of this, practices are best evaluated at each operation.¹⁷⁶

2.2 Energy Generation

The U.S. depends on international sources for much of its energy needs; as a result, energy prices tend to reflect international market conditions, particularly those of crude oil supplies. This dependence on imports makes the U.S. vulnerable to unexpected price movements and supply disruptions in international energy markets. Agriculture is one industry that is particularly vulnerable to the volatility of energy prices since it relies on petroleum and natural gas markets.¹⁷⁷ This volatility in petroleum and natural gas markets also affects synthetic fertilizer markets, as seen in *Inputs: 6.3 Fertilizers*. Producers are slowly gaining more options for responding to energy price changes, but in the short term most energy price increases still translate into lower farm income.¹⁷⁸

Agriculture's role as a consumer of energy is well known, but its capacity to produce energy is less well understood.¹⁷⁹ Energy production from farm-based operations has grown rapidly in recent years, but still remains a small fraction (less than one percent) of national energy needs.¹⁸⁰ The majority of energy production growth has come from increased renewable energy capacity (primarily from biofuels and wind), but this growth has relied heavily on federal and state programs and incentives.¹⁸¹ More studies need to be conducted to determine the return on investment for farmers investing in energy generation capacities. According to the 2007 Agriculture Census, there are 31 farm operations in Boulder County that have installed renewable energy production capacity.¹⁸²

Solar

Solar electric energy systems, or photovoltaics (PV), can supply power for any number of remote agricultural applications, including pumping and electric fencing. PV systems can also be used to generate electricity for lighting buildings or operating equipment and appliances. There are two main options for solar electric systems: (1) they can be designed to tie into the power grid, feeding any excess power back into the grid to run the meter backwards; or (2) at remote sites, PVs can be connected with storage batteries to provide a reliable power supply for a more specific application.¹⁸³

Generally one of the best applications for solar-PV from a use and financial standpoint is for irrigation purposes.¹⁸⁴ When water pumping systems use less than 1.5 kilowatts (kW), small solar PV systems can be easily installed and are more advantageous than wind because they can better meet the water pumping demand and require less maintenance (e.g. fewer moving parts). Ideally these systems can be tied into the grid, so when water pumping is not needed the excess electricity can be sold back to the grid.¹⁸⁵ As the power requirements for irrigation systems increase, however, a wind only or a hybrid wind/solar water pumping system has been found to be more economical. Due to the marginal potential for wind in Boulder County, the economic viability of these systems will be reduced.¹⁸⁶

The financial viability of solar energy systems for agricultural purposes is difficult to evaluate as a number of factors contribute to the final price of a system, including system requirements, location, financial rebates, and labor. To add to the complexity, the current system of financial rebates provided at the federal, state, and utility level are not fixed and are currently expected to decrease, potentially making small solar PV systems of 0.5 to 10 kW uneconomical at current energy prices.¹⁸⁷

Wind

The total installed wind energy production capacity has expanded rapidly in the U.S. from 1998 to 2009, rising from 1,848 megawatts (MW) to nearly 35,000 MW.¹⁸⁸ Over the past 20 years, the cost of wind power has fallen about 90 percent, while rising natural gas prices have pushed up costs for gas-fired power plants, helping to improve the market competitiveness of wind energy.¹⁸⁹ However, on average, wind power turbines typically operate the equivalent of less than 40 percent of the peak (full load) hours in the year due to the intermittency of wind.¹⁹⁰

The National Renewable Energy Laboratory ranks Colorado as the 11th best place in the nation to generate energy from wind, with the potential to provide up to nine percent of the electricity for the contiguous U.S.¹⁹¹ While Colorado has strong potential for wind energy, Boulder County, as shown in Figure 10, does not have strong capacity for wind energy production due to a wind resource potential of poor to marginal. There may be specific sites within the County where wind speeds might be conducive for producing energy, but overall potential for wind energy in Boulder County is low.¹⁹²

Figure 10: Wind Power Potential in Colorado

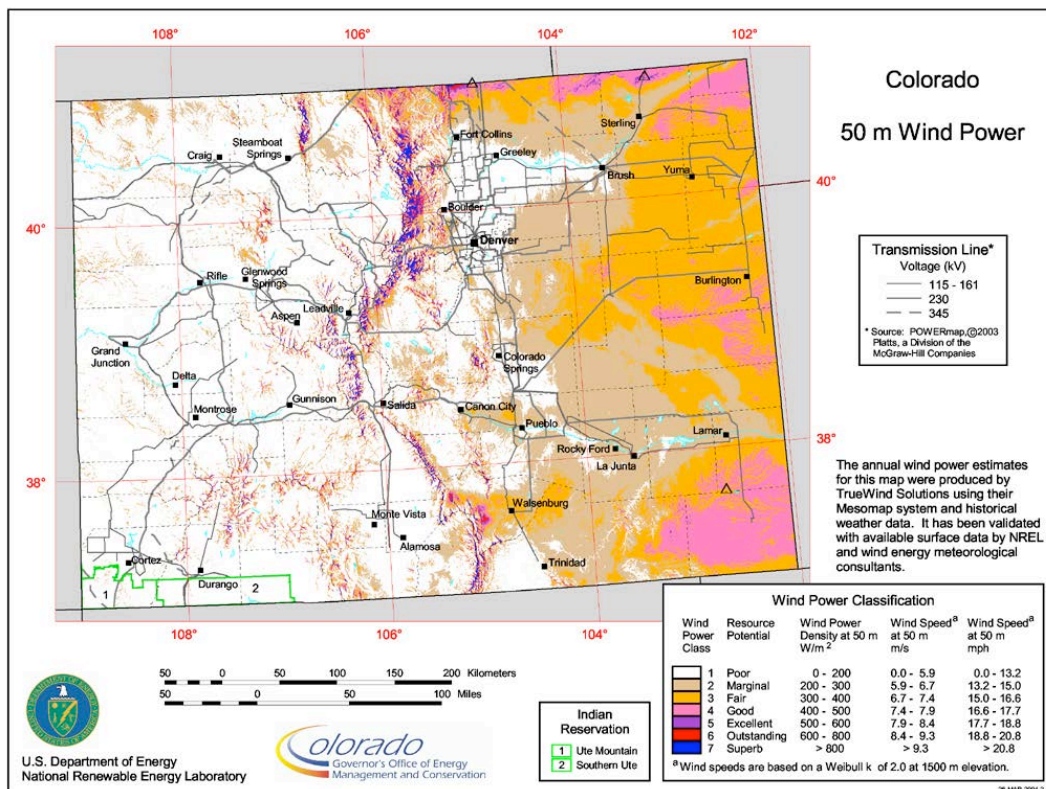

Biofuels

Biofuels, which are typically liquid or gas energy sources produced from biomass, are another method of energy generation. They can be both produced and used on farms, or produced on farms for sale and used elsewhere. Biofuels are either from crops grown directly for production, or from crop residue. Biofuels include ethanol, biodiesel, methanol, and reformulated gasoline components.¹⁹³ Biofuels vary greatly in energy efficiency, government support, production, usage, and distribution. Ethanol and biodiesel are both liquid fuels produced on the farm primarily for off farm use attempting to make transportation more environmentally-friendly.¹⁹⁴ Other varieties of biofuels, including methanol production, can be used on farm or for home uses such as heating and cooking.¹⁹⁵

Graph 3: U.S. Biofuel Production, 1990-2008¹⁹⁶

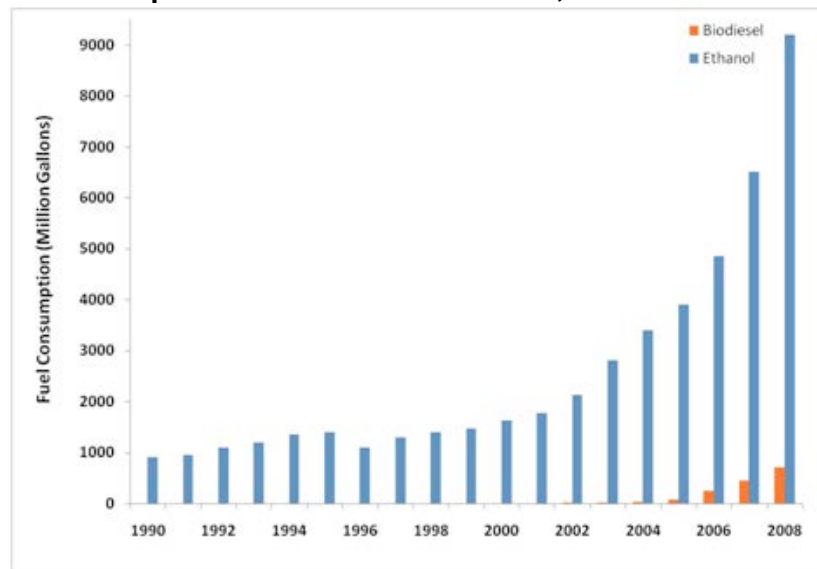

Ethanol is the most common biofuel, used as an additive to gasoline in Colorado and in the U.S. Corn based ethanol has been shown to place pressure on global food markets by raising food prices.¹⁹⁷ Corn based ethanol competes with food production for both land and resources, but has significant government support in competing directly with petroleum based gasoline. There are a number of programs to support corn-based ethanol in Colorado.^{198, 199} The residue from ethanol production can be used to feed animals, but 66 percent of the original weight of the corn is lost.²⁰⁰ Cellulosic ethanol, an alternative that uses woody plants as a feedstock, has significant technical barriers and is not yet cost competitive with other forms of ethanol.²⁰¹ Biodiesel is produced from fats such as soybean oil or animal fats. Both corn ethanol and biodiesel have been found to have positive energy and climate benefits,^{202, 203, 204} though some studies have shown corn ethanol to have a negative energy balance.²⁰⁵ According to the Department of Energy, “most of the studies, and more importantly, the preponderance of recent studies, show that ethanol has a positive net fossil energy value,” as shown in Graph 4.²⁰⁶

Graph 4: Identified Energy Balance of Corn Ethanol from Selected Studies²⁰⁷

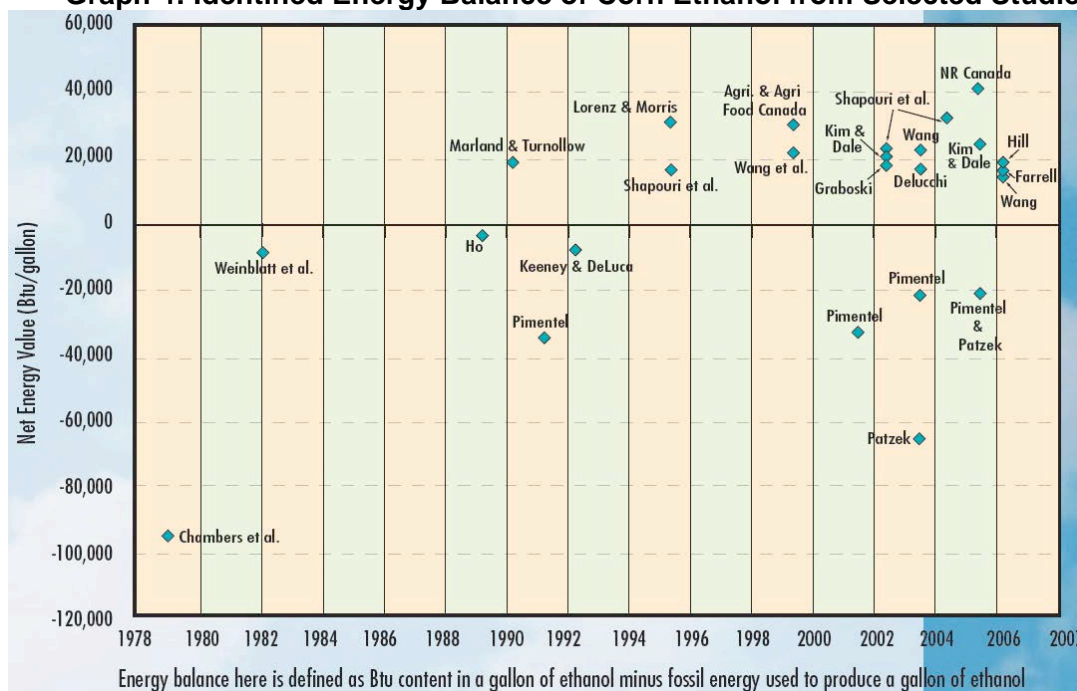

Biomass

Another option is the use of plant material (biomass, wood). In the photosynthetic process incoming solar radiation is converted into structural plant material (wood). At the end of the growing season the crop is harvested and the wood is used as feedstock for electricity plants.²⁰⁸ There are complexities concerning energy balance of biomass conversions and some plants may be used more effectively if they are converted to gas or liquid fuels, but the technology is rapidly improving. Another concern is the re-planting, which must take place to offset the carbon impact of burning biomass.²⁰⁹

Anaerobic Digesters

An anaerobic digester is a device that promotes the decomposition of manure or “digestion” of the organics in manure by anaerobic bacteria, in the absence of oxygen, to simple organics while producing biogas as a waste product. Anaerobic digesters are most feasible alongside large confined animal feeding operations. According to the USDA, biogas production for generating cost effective electricity requires manure from more than 150 large animals.²¹⁰ As animal feeding operations steadily increase in size, the opportunity for anaerobic digestion systems will likewise increase.²¹¹ In Boulder County there are roughly 15,000 cattle with only two operations having more than 500 animals potentially meeting the USDA concentrated animal feeding operation definition.²¹² These cattle could provide sufficient manure to power anaerobic digesters. Since anaerobic digestion substantially reduces ammonia losses, the effluent is more nitrogen-rich than untreated manure, making it more valuable for subsequent field application. Also, digested manure is high in fiber, making it valuable as a high-quality potting soil ingredient or mulch.²¹³



The primary benefits of anaerobic digestion are animal waste management, odor control, nutrient recycling, greenhouse gas reduction, and water quality protection. Except in very large systems, biogas production is a highly useful but secondary benefit. As a result, anaerobic digestion systems do not effectively compete with other renewable energy production systems on the basis of energy production alone. Instead, they compete with and are cost competitive when compared to conventional waste management practices, according to the Environmental Protection Agency.²¹⁴

3. Water Use

Summary

The semi-arid climate in Boulder County and surrounding areas provides limited water resources for agricultural, industrial, and urban uses. In the region, demand and competition for water is expected to increase in the future as the urban population continues to grow and as shifting climatic changes affect the regional water cycle by raising average temperatures and decreasing precipitation rates. As a whole, this is expected to make the area more dependent on winter snowmelt and the water storage capacity of local reservoirs and lakes.

In Colorado, irrigated agriculture is the largest user of water representing 80 percent of all surface and groundwater use in the State. In Boulder County, roughly 25 percent, just under 34,000 acres, of agricultural land is irrigated. This represents a seven percent increase since 2002, but is still significantly lower than the 68,000 acres that were irrigated in the County in 1968.

Literature highlights five principal methods of irrigation used in Boulder County: **furrow irrigation, border irrigation, controlled flooding, sprinkler irrigation, and corrugation irrigation**. As identified in 2007 by the United States Department of Agriculture (USDA), the main irrigated crops in Boulder County by acreage were forage, corn (grain), barley, wheat (grain), and corn (silage/greenchop).

It was widely reported that in order for agriculture to continue to increase production, it is necessary for agricultural systems to increase the capture and utilization of precipitation and reduce or improve the efficiency of irrigation water needs. Changes identified include using conservation tillage practices and cycling in lower water requirement crops that have different critical times for water. A number of studies showed that conservation tillage operations allow for greater soil water availability than conventional tillage practices by building capillary spaces for water movement and improving water retention. This reduces overall water demands by roughly 12 percent, while increasing water retention and **percolation** 25-50 percent. Irrigation scheduling can also be used to maximize irrigation efficiency by measuring and monitoring soil moisture so that water can be applied in more precise quantities at the most effective times for the particular crop.

In order for agricultural producers to continue to create desirable crop growth during times of water scarcity and increased competition, it will be necessary to have good soil conditions that provide optimum soil aeration, water infiltration, and **permeability** as well as uniform root development. Additionally, improved soil quality will help to reduce runoff and decrease potential soil erosion.

3.1 Supply and Demand

The semi-arid climate in Boulder County and surrounding areas provides limited water resources for crop and livestock production. As demand for water from growing urban areas continues to increase, the availability of water for agriculture will face increasing competition. The already increasing competition between agriculture and urban areas for water resources (Figure 11) will likely be intensified due to shifting climatic changes, which will affect the use of water in two main ways. The first is that crops may require more irrigation water to produce the same yields because of decreases in precipitation and increases in drought. Second, the water available for irrigation could decrease significantly due to lower precipitation rates and warmer temperatures.^{215, 216, 217}

According to the Statewide Water Supply Initiative (SWSI), the Front Range will continue to be the most populous place in Colorado with over 80 percent of the state's population residing in the Arkansas, Metro, and South Platte Basins. The SWSI predicts that by 2050 there will be a significant municipal and industrial (M&I) water supply gap in Colorado, between 32 and 66 percent of new demands. The South Platte Basin is projected to have an M&I gap of 58 percent.²¹⁸ Consequently, water storage and management will become increasingly more important as the timing of snowmelt and irrigation water demand change.²¹⁹

Figure 11: Increasing Competition for Water Resources Globally¹

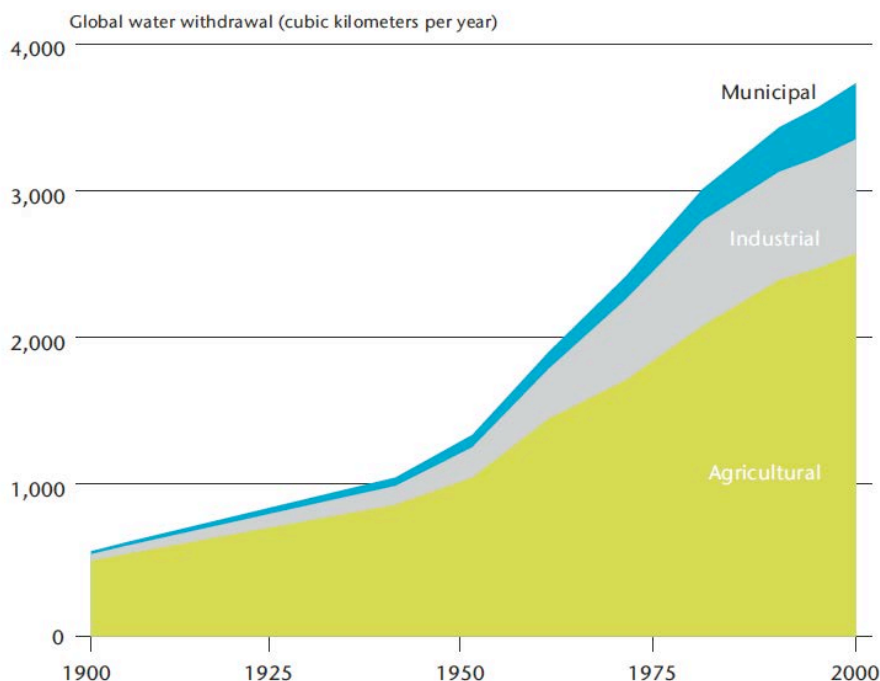

Irrigated agriculture is the largest user of water in Colorado representing 80 percent of all surface and groundwater use,²²⁰ a rate that is consistent with other regions nationally.²²¹ Within the South Platte River Basin there are two main sources of water for irrigation and domestic water use in Boulder County: streams and storage reservoirs. The various streams in the South Platte River Basin include Boulder and South Boulder Creeks, and the Left Hand and St. Vrain Creeks. The storage reservoirs include Highland Reservoir No 2, Foothills Reservoir, Base Line Lake, Marshall Lake, and Left Hand Valley Reservoir. Figure 12 shows the main river basins in Colorado and their main tributaries. The Colorado Big Thompson Transmountain Diversion Project provides additional water to the Front Range from the Western Rockies, to help ensure a supply of late-season irrigation water during most years.²²²

Figure 12: Major Geologic Regions and River Basins²²³

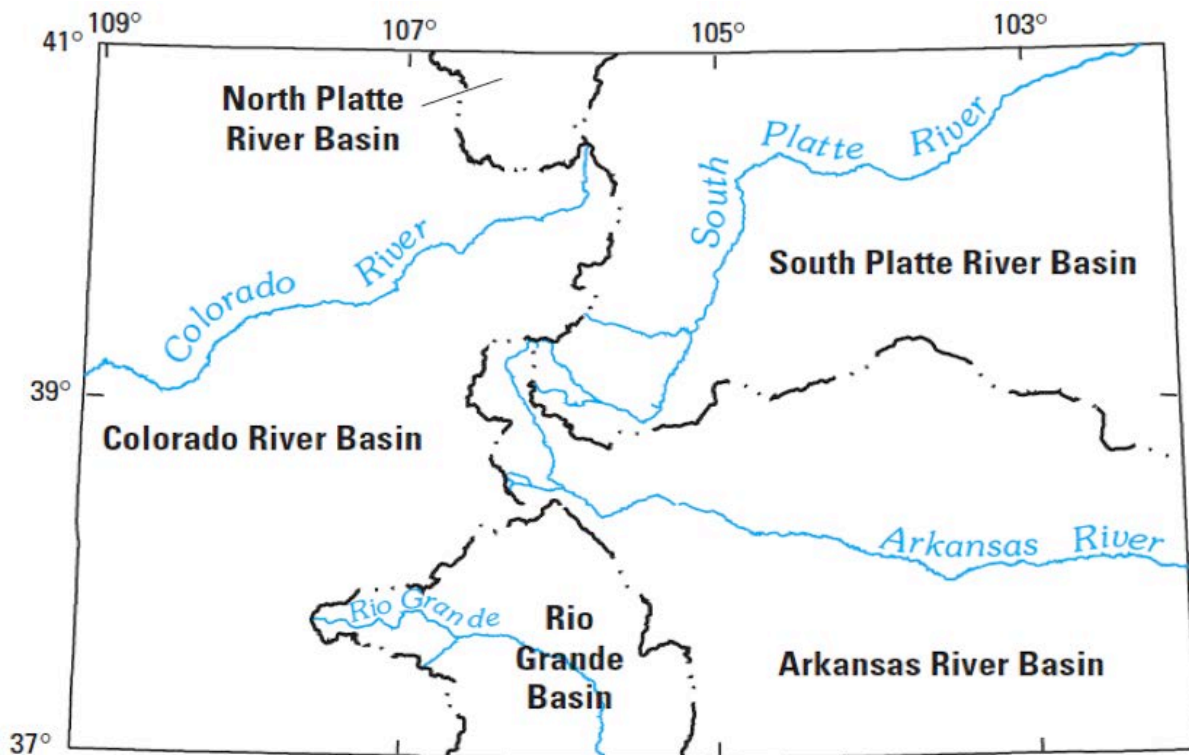

Irrigated Land

In 1968 about 68,000 acres in the Boulder Area were irrigated.²²⁴ As of the 2007 Department of Agriculture Census, 33,871 acres, roughly 25 percent, of the agricultural land in Boulder County were irrigated. While the amount of irrigated land has decreased since 1968, there has been a seven percent increase since 2002.²²⁵ As shown in Figure 13, the majority of irrigated land is in the eastern part of the County, although a few areas of meadowland are irrigated in the foothills and mountains.²²⁶

Figure 13: Irrigated Agricultural Land in Boulder County

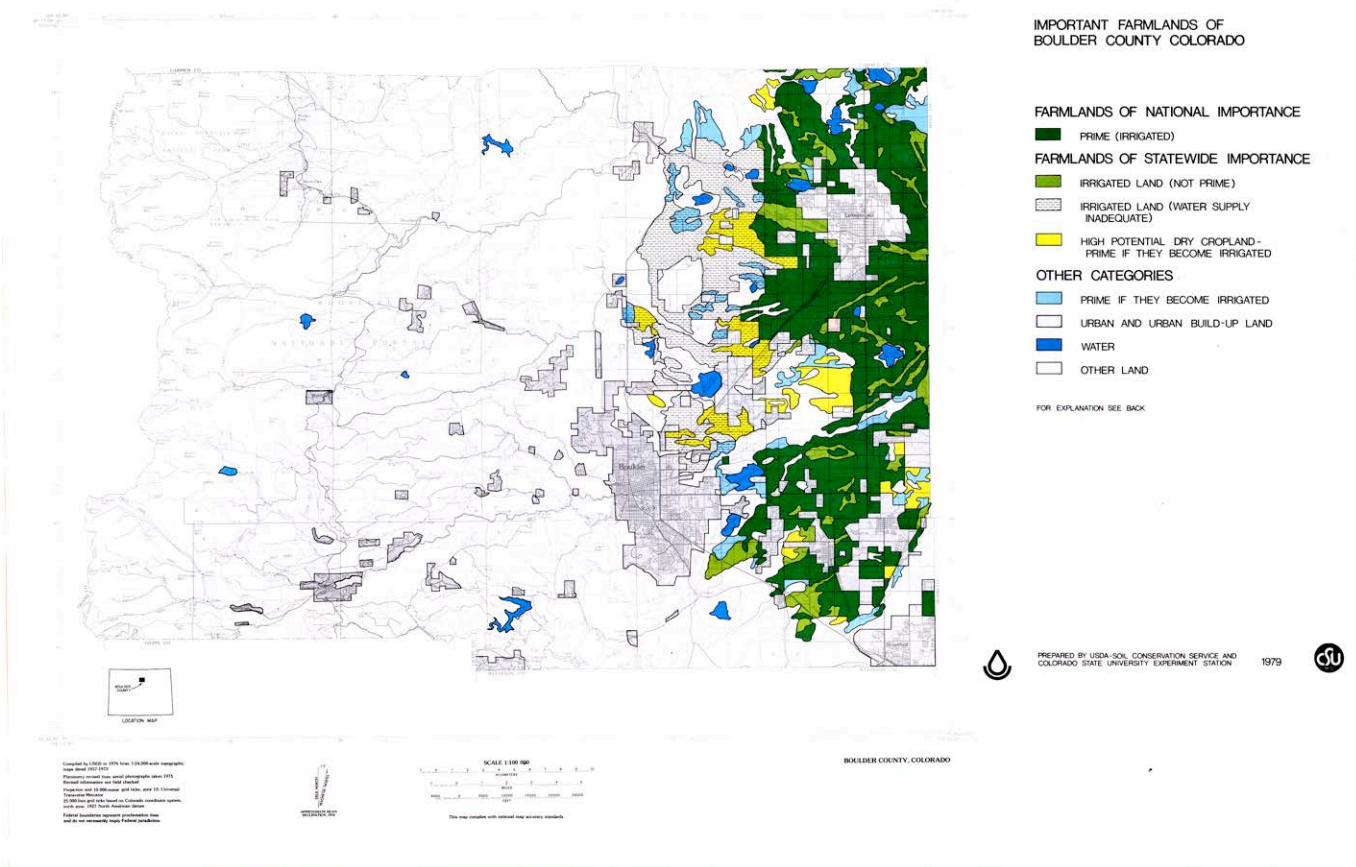

3.2 Irrigation Management

According to the USDA, effective irrigation management requires accurate timing and regulation of water applications in a way that satisfies crop water requirements while not wasting water, soil, and plant nutrients or degrading the soil.²²⁷ This involves applying water:

- According to crop needs
- In amounts that can be held in the soil and be available to crops
- At rates consistent with the intake characteristics of the soil, so as not to increase erosion
- To ensure water quality is maintained or improved

Crop water use, also known as **evapotranspiration** (ET), is the combination of **transpiration**, the amount of water plants use for growth and cooling purposes, and evaporation, water evaporated from adjacent soil surfaces.^{228, 229} Crop water use is influenced by a variety of factors including prevailing weather conditions, available water in the soil, crop species, and the growth stage of the crop.^{230, 231} Most crops are more sensitive to water stresses during one or more critical growth periods in the growing season. Moisture stress during a critical period can cause an irreversible loss of yields and reduction in the quality for crops.²³²

The main irrigated crops in Boulder County by acreage include:²³³

- Forage – 21,319 acres
- Corn (grain) – 2,499 acres
- Barley – 1,263 acres
- Wheat (grain) – 797 acres
- Corn (silage/greenchop) – 671 acres
- Vegetables and other small grains such as millet to a smaller extent

Method of Irrigation

On a farm or field scale there are a number of water conservation practices that can be employed to increase the efficiency of irrigation, but due to the specific nature of agricultural operations no one practice is universally appropriate.²³⁴ The latest soil survey (2007) conducted by the USDA identified five principal methods of irrigation used in Boulder County.²³⁵ Working definitions of each of these methods are provided below.

Furrow irrigation is used with row crops. Water is taken from ditches by siphon tubes, gated pipes, or cuts in the ditchbank, and is applied in the furrows between the rows of plants. On sloping soils the use of contour furrows helps to control erosion by carrying water across the slope. On nearly level soils the furrows are straight.

Border irrigation is used on nearly level fields that are planted with close-growing crops. In border irrigation water soaks into the soil as it advances down narrow strips between the ridges. Uniform grades are necessary to ensure an even distribution of water and to prevent ponding.

Controlled flooding is used on close-growing crops. Water is flooded down the slope between closely spaced field ditches.

Sprinkler irrigation is used when slopes are steep or uneven. Sprinklers are an advantage when establishing pasture crops and in the preemergence irrigation of certain crops. With sprinkler irrigation, water losses resulting from evaporation may be higher than with other methods of irrigation and wind drift may cause uneven water application.

Corrugation irrigation is useful on fields that do not have uniform grades.

The amount and type of water loss that occurs when irrigating a crop field is highly dependent on the type of delivery and distribution system used (Figure 14). The relative efficiency of different irrigation systems is a result of changes in the amount of runoff, deep percolation, and evaporation. One of the most common conversions of irrigation methods to increase efficiency is from surface irrigation to sprinkler irrigation.²³⁶ The reason for this conversion is that surface irrigation is inherently less efficient and more labor intensive than sprinkler irrigation.

Figure 14: Range of Field Efficiency for Irrigation Systems^{237 238}

Irrigation System	Field Efficiency (% Range)
Surface Irrigation Systems	
Graded Furrow	50-80
w/tailwater reuse	60-90
Level Furrow	65-95
Graded Border	50-80
Level Basins	80-95
Sprinkler (non-center pivot)	
Periodic Move	60-85
Side Roll	60-85
Moving Big Gun	55-75
Lateral Move	
Spray heads w/hose feed	75-95
Spray heads w/canal feed	70-95
Center Pivot Irrigation Systems	
Impact heads w/end gun	75-90
Spray heads w/o end gun	75-95
LEPA w/o end gun	80-95
Microirrigation Systems	
Surface Drip	70-95
Subsurface Drip Irrigation (SDI)	75-95
Microsprinklers (microspray)	70-95

Whether to reduce the number of irrigated acres or irrigate at a rate less than adequate capacity can be a difficult decision when water is limited due to either supply constraints or system capacities. A study conducted in Western Kansas found that net returns to land and management are reduced when all acres are irrigated at less than adequate capacities compared to reducing irrigated acres while maintaining adequate capacity.²³⁹ When irrigation was reduced below optimum supply for all acres, overall corn yields were reduced, compared to maintaining an adequate supply with fewer acres.²⁴⁰

Crop rotation has been found to help increase yields in water-limited systems. A study conducted by Schneekloth found that net returns were greater when a three-year rotation of corn-soybean-wheat was irrigated compared to a continuous corn rotation. The increase in yields was attributed to the increase in corn grain yields following wheat and the inclusion of lower water use crops such as soybean and wheat, which had yields that were closer to fully-irrigated grain yields when compared to the corn yields.²⁴¹

Changes in agronomic practices can increase the capture and utilization of precipitation and reduce irrigation water needs. Changes include using no-till practices and cycling in lower water requirement crops that have different critical times for water. Crop rotation can extend the irrigation season and allow for longer operation of irrigation systems with proper irrigation management. This allows for producers with low capacity systems to effectively manage the irrigation.²⁴²

Crop Water Use

Water requirements for crops depend mainly on environmental conditions, with the prevailing weather conditions being the driving force. Different crops have different water use requirements, even under the same weather conditions. For example, according to CSU, “in the Greeley area, the seasonal water use of sugar beets is 30 inches while corn for silage uses only 22 inches of water. That means sugar beets require 36 percent more water than corn to fully irrigate.” These water requirements are the amount a crop will use (not counting water losses such as deep percolation and runoff) in an average year. Figure 15 shows the average water requirements for selected crops in Longmont, CO.²⁴³

Figure 15: Estimated Seasonal Water Requirement (consumptive use) in Longmont, CO (inches/season)²⁴⁴

Crop	Longmont
Alfalfa	30.91
Grass hay/ pasture	26.17
Dry Beans	15.83
Corn, Grain	21.66
Corn, Silage	24.28
Spring Grains	11.36
Sugarbeets	25.48
Winter Wheat	18.46
Average Precipitation	12.74

Irrigation Scheduling

In Colorado's semi-arid climate, irrigation is used as a supplemental water source when ET is greater than precipitation, which is often.²⁴⁵ Irrigation scheduling is used to maximize irrigation efficiency by minimizing runoff and percolation losses. This can result in decreased energy and water use and optimum crop yields, but can also result in increased energy and water use if not managed properly.²⁴⁶ Proper irrigation scheduling applies the necessary amount of water at the right time, making sure that crops get the water they need in an efficient manner. Measuring and monitoring soil moisture can help determine when to irrigate, how much water to apply, and the amount of plant available water in the root zone. This information can help improve crop yields, increase irrigation efficiency, stretch limited water supplies, and reduce runoff pollution.²⁴⁷ Crop water use can be estimated by a number of methods including evaporation pans, weather data to calculate ET, and soil-moisture monitoring.²⁴⁸ Irrigation scheduling is a management tool that can help to avoid over or under irrigating.²⁴⁹

The texture and water holding capacity of soil affects both the timing and quantity of irrigation. Furthermore, the plant root zone determines the soil depth from which the crop can draw moisture. Plants typically show signs of wilting and water stress before they use all of the available water stores in the soil. However, for some crops, yield loss occurs by the time water stress symptoms appear. Soil moisture should be measured initially and monitored regularly to determine the available soil moisture. Figure 16 shows the root zones of mature crops and the percent of total available moisture that can be depleted via ET without suffering yield loss. The crops in Figure 16 depend on the moisture in their root zones for 90 percent of their water needs.²⁵⁰ For example, generally 30-50 percent of water in the root zone of alfalfa can be withdrawn without loss of crop yield.²⁵¹

Figure 16: Root Zone Depth and Allowable Depletion Percentages for Various Crops^{252, 253}

Crop	Allowable depletion (%)	Root depth* (ft.)
Alfalfa	30-50	4.0-6.0
Barley and oats	55	3.3-4.5
Beans	50-70	2.0-3.0
Cantaloupes and watermelons	40-45	2.6-5.0
Carrots	35	1.5-3.3
Corn	40-60	2.5-4.0
Lettuce	30	1.0-1.6
Onion	25-50	1.5-2.0
Pasture	40-60	3.0-4.0
Potatoes	25-50	2.0-3.0
Sorghum	40-60	3.0-4.0
Soybeans	50	2.0-4.1
Sugar beets	30-60	3.0-4.0
Sweet Peppers	30	1.6-3.2
Zucchini and cucumbers	50	2.0-4.0

Adapted from both Colorado State University Extension and Texas Cooperative Extension.

The strategy used for irrigation management varies depending on the type of crop and its soil moisture tolerances. For systems that apply vary large amounts of water infrequently, the irrigation cycle should be timed so water is applied before the allowable depletion in the root zone is reached. Often, irrigation systems that must apply heavy applications must begin the irrigation cycle before there is room in the soil to store the full application. Conversely, crops such as potatoes, onions, and peppers generally require more frequent irrigation. Irrigation ditches may not be able to accommodate this frequent irrigation. Although not always possible, irrigation application should be limited so that the root zone is not overfilled.²⁵⁴

3.3 Water Conservation

To create desirable crop growth it is necessary to have good soil conditions that provide optimum soil aeration, water infiltration, water percolation, water movement, and permeability as well as uniform root development. Additionally, good soil quality helps to reduce runoff and decrease potential soil erosion. The USDA National Irrigation Guide identified improvements to soil quality that would help increase water use efficiency: eliminating excess tillage operations, avoiding field operations while soil water content is high, using organic material or crop residue, and using grass and legumes in rotation.²⁵⁵ Mitigation of compaction layers is also important for water movement in soil.

Compaction Layers

Soil compaction occurs when soil particles are pressed together, reducing the pore space between them. Fine textured soils (clayey and silty) are more vulnerable than coarse textured soils (sandy) to compaction. Compaction results in decreased infiltration and percolation, which leads to an increase in runoff and water erosion potential while also reducing the effective rooting zone. One important factor that influences soil compaction is the water content of the soil. For example, dry soil is more resistant to compaction.²⁵⁶ The most significant soil compaction occurs during tilling, harvesting, and grazing when soils are wet. Soil compaction can extend to 20 inches below the surface.²⁵⁷ Although wheel traffic is a more obvious and direct cause for compaction, tillage operations are also a factor.²⁵⁸ Tillage practices can “break up soil structure, speed the decomposition and loss of organic matter, increase the threat of erosion, destroy the habitat of helpful organisms, and cause compaction.”²⁵⁹

A number of actions can be taken to mitigate the compaction of layers. Additions of organic matter, such as manure and compost, can have many positive affects on soil including protection from erosion and compaction.²⁶⁰ Soil stability and biodiversity also aid in the prevention of soil compaction.²⁶¹ Deep ripping subsoiling at appropriate soil moisture conditions can break apart compaction layers, but require 30-75 horsepower per shank, depending on the soil type. Clay soils are very difficult to break up.²⁶² Although certain tillage operations can lead to compaction, it is possible to decrease soil compaction in combination with executing conservation tillage systems.²⁶³

A series of compaction tests were completed at the Central Great Plains Research Station near Akron, Colorado. The study was performed due to concerns that the practice of no-till, in the long-term, could result in increased soil compaction and possible degradation of the soil.²⁶⁴ A decrease in the soil's least limiting water range was found to have a direct impact on yield loss.²⁶⁵ Understanding compaction characteristics of the soil and the response of the crop to soil physical conditions is vital for farmers when making informed decisions on field management.²⁶⁶ The study's findings support that soil compaction has the potential to limit crop production. The economic considerations of soil compaction are difficult to quantify since they can be both direct and indirect.²⁶⁷

The choice of tillage practice for water conservation purposes depends on a wide range of factors, including soil erodibility (soil texture, slope, organic matter content), the irrigation system used, the equipment available, and rotation with other crops. Tillage methods should be selected based upon which practice eliminates all or the most runoff

from irrigation and precipitation.^{268, 269} Reduced- and no-till operations have been shown to allow for greater soil water availability than conventional tillage practices by building capillary spaces for water movement and improving water retention. These practices have reduced water demands by up to 12 percent, according to the USDA.^{270, 271}

Covering soil with mulched cover crops can reduce water loss from the soil. Creating a rough soil surface increases the area available to catch raindrops, thereby maximizing water availability and retention, and mitigating water losses.²⁷² Improving soil structure and organic matter content helps soil to retain water and also improves the availability of water to plant roots. Increased organic matter can increase water retention²⁷³ and improve water percolation by up to 25-50 percent.²⁷⁴ Additionally, improved soil stability reduces erosion and the resulting runoff.

Efficiency of Ditch Delivery

Unlined or earthen ditches are one of the least efficient irrigation delivery systems due to seepage losses through the soil (Figure 17). Estimates of water loss through seepage from unlined ditches have been calculated as high as 45 percent with the U.S. Department of Interior estimating a 22 percent average.²⁷⁵ Methods proposed to improve the water delivery and efficiency of use include lining earthen ditches with impermeable materials to prevent seepage and replacing unlined ditches with pipeline delivery systems that can improve the efficiency by 10 percent (Figure 17).²⁷⁶

Figure 17: Potential On-farm Conveyance Efficiencies²⁷⁷

Fields larger than 50 ac	Conveyance Efficiency
Unlined	80%
Lined or Piped	90%
Fields up to 50 ac	
Unlined	70%
Lined or piped	80%

Inefficient irrigation from unlined ditches can have offsite benefits, such as providing habitat for a variety of wildlife, acting as an important source of recharge to shallow groundwater, and possibly providing groundwater return flow to streams and rivers.²⁷⁸ In instances where these unlined ditches provide important off site benefits and the seepage is reduced by the addition of linings, there may be adverse effects to the beneficiary systems, which include ground water recharge, wildlife habitats, and wet areas. According to the USDA “without consideration and careful planning, irrigation project activities can negatively impact water quantity and quality, wetlands, fisheries, and wildlife.”²⁷⁹

Considerations when evaluating the impacts of lining ditches include, but are not limited to:²⁸⁰

- The effects on downstream flows or aquifers that would affect other water uses or users.
- Potential changes in growth and transpiration of vegetation located next to the ditch because of the elimination of leakage from the system.
- Effects on wetlands or water-related wildlife habitats.
- Water and energy savings resulting from decreased water loss and improved irrigation water management.

4. Water Pollution

Summary

Agriculture in the U.S. is the largest contributor to non-point source water pollution according to the Environmental Protection Agency (EPA). Agriculture often contributes to surface and groundwater pollution by increasing the discharge of chemicals and sediment, waterlogging irrigated land, and causing **salinization**. While agriculture contributes significantly to water pollution it is also heavily impacted itself by polluted water, as poorly treated wastewater can contaminate crops and transmit diseases throughout the food chain.

The most significant agriculturally derived water contaminant in the U.S. is nitrate. Nitrate pollution from agricultural operations comes from nitrogen runoff primarily from animal manures, synthetic and organic fertilizers, and atmospheric deposition. In the Front Range urban corridor, the Colorado Department of Agriculture tested over 40 groundwater sources for nitrate leaching from the surrounding agricultural land and industry. Roughly twelve percent of the wells were found with nitrate levels exceeding the allowable EPA maximum concentration level.

Apart from nitrate, pesticides represent the most significant water pollution and health concern for agriculture. In the South Platte River Basin, pesticides have been detected in over 90 percent of the wells sampled in both urban and agricultural areas. The high level of detection places the basin in the highest 25 percent of all water basins tested nationally. The most commonly detected pesticide was atrazine, which was found in roughly 61 percent of the wells sampled. Alachlor, metolachlor, and simazine were also detected.

The storage and competing uses of water along the Front Range place additional concerns on pollution from agriculture. According to the Colorado Water Resources Research Institute, most of the reservoirs along the Colorado Front Range have rates of **eutrophication** that are a cause for concern. High rates of eutrophication typically occur when runoff from over or recently fertilized and manured agricultural lands deliver large amounts of nitrogen and phosphorus to water bodies that are nutrient limited. While increased levels of nutrients in irrigation water may be advantageous for farmers since they help reduce the need for fertilizers, they also present a multitude of problems for managers of municipal drinking water.

Management emphasis has now shifted from irrigation to drinking water for many Front Range Reservoirs. This creates problems as reservoirs used for irrigation water have different management priorities than drinking water reservoirs. Drinking water needs to be more pure and has tighter standards, such as maximum contaminant levels for nitrates (NO₃), manganese (Mn), and iron (Fe).

4.1 Agricultural Water Pollution

Agriculture is one of the largest users of freshwater resources both globally (70 percent of surface water) and in Colorado (80 percent of surface and ground water). Except for losses through evapotranspiration, water from agricultural operations is cycled back into surface water and groundwater. As highlighted by the United Nations Food and Agriculture Organization (FAO), this water cycle makes agriculture both a cause and victim of water pollution. Agriculture often contributes to surface and groundwater pollution by increasing the discharge of chemicals and sediment, waterlogging irrigated land, and causing salinization. Agriculture becomes a victim when it unknowingly uses poorly treated wastewater and polluted surface and groundwater, contaminating crops and transmitting disease to both consumers and farm workers.²⁸¹

According to the Environmental Protection Agency, agriculture in the U.S. is considered to be the most widespread contributor to **non-point source pollution**.^{282, 283} Non-point source pollutants differ from **point source pollution** in that they do not have a specific point of origin and are generally transported across a wide medium and range. The main categories of agricultural non-point source pollutants include sediment, pesticides, nutrients, and pathogens.²⁸⁴ In agricultural operations, these non-point source pollutants are generally transported overland and through the soil by rainwater and melting snow. These pollutants then find their way into groundwater, wetlands, rivers, lakes, and ultimately oceans in the form of sediment and chemical loads carried by rivers. The impacts of these pollutants range from simple nuisance substances to more severe ecological health, human safety, and legal impacts.

According to the FAO, controlling furrow irrigation and its tailwater, which is the primary carrier source pollution from agricultural operations, is best managed:

“At the field level, where decisions are influenced by very local factors such as crop type and land use management techniques, including use of fertilizers and pesticides. These decisions should be based on best management practices that are possible under the local circumstances and are meant to maximize economic return to the farmer while safeguarding the environment.”²⁸⁵

The overall quality of surface and groundwater has decreased in many parts of the world due to intensive land management practices and the consequent imbalance of carbon, nitrogen, and water cycling in the soil. Furthermore, agricultural pollutants, such as nitrates and pesticides, have been found in the drinking water of nearly all 50 U.S. States.²⁸⁶ A study conducted in the Boulder Creek Watershed found that pollutant concentrations were low in the headwaters, but increased through the urban corridor and had a further significant increase downstream from the first major wastewater treatment plant, which is the output of municipal water pollution. Despite low overall concentrations upstream, pesticides were still detected in both upstream and downstream regions of Boulder Creek, but concentrations and loads of anthropogenic-derived contaminants increased as basin population density increased through the watershed.²⁸⁷

The urban use of pesticides (specifically herbicides, insecticides, and fungicides) account for about one-third of pesticide usage in the U.S. with about 70-97 percent of homes using one or more pesticides.^{288, 289} Pesticides are used for residential and

public landscaping, commercial and industrial buildings, and household insect control. Runoff from urbanized surfaces as well as municipal and industrial discharges results in increased loading of nutrients, metals, pesticides, and other contaminants to streams.²⁹⁰ The frequency of pesticide detection is high in urban streams and at concentrations frequently exceeding guidelines for aquatic environments.^{291, 292} Urban runoff is not a significant contributor to water pollution in the upper South Platte River Basin (i.e. Boulder County), but likely increases as urban concentrations increase further downstream.

4.2 Sediment Pollution

Erosion is a net cost to agriculture because farmers must replace the lost nutrients and organic matter with fertilizers at considerable cost in order to maintain soil productivity.²⁹³ The two major categories of agricultural pollution caused by sediment are physical and chemical.²⁹⁴

Physical sediment pollution includes top soil loss and land degradation caused by erosion that lead to high rates of **turbidity** in receiving waters and increased rates of deposition in river and lake beds. High levels of turbidity in waterways limit the amount of sunlight penetration, which limits and prohibits the growth of important algae and aquatic plants. While high turbidity can be beneficial in highly eutrophic waterways, it is commonly recognized for its negative impacts on flood control, channel management, navigation, and waterway aesthetics. Turbidity also clogs hydraulic facilities and irrigation systems.²⁹⁵

The severity of chemical pollution from sediment is affected by both the particle size of the sediment and the amount of particulate organic carbon associated with the sediment. Silt and clay soils under 63 μm (micrometers) are often the primary carrier of absorbed chemicals, specifically phosphorus, chlorinated pesticides, and metals. Larger modeling of phosphorus transport in the U.S. has shown that as much as 90 percent of phosphorus transport in rivers is in the smaller suspended sediment. The most chemically active sediment, and that of the most concern, is that portion which is smaller than 63 μm , usually silt and clay. Most of the persistent, bioaccumulating, and toxic organic chemical pollutants, especially chlorinated compounds such as pesticides, are strongly associated with sediment load in aquatic systems and particularly with the organic carbon concentrations of that sediment.²⁹⁶ Ultimately, as sediment containing toxic compounds is ingested by benthic bottom dwelling organisms and fish, these chemicals enter the food chain. This leads to the accumulation of pesticides and other toxic compounds in top predators, including man.

The level of observed bioaccumulation in relation to stream location varies depending on a variety of factors including species mobility, trophic level, and the location of feeding sites. Smaller, less mobile species, at a lower trophic level (e.g. insects) tend to see considerably higher levels of bioaccumulation at downstream sites in relation to upstream sites.²⁹⁷ With larger, more mobile species (e.g. some fish and birds), however, higher levels of bioaccumulation can be observed upstream of pollution sources.^{298, 299} Therefore it can be inferred that Boulder County as an early user of water has relatively low bioaccumulation with lower trophic level species, but may experience higher levels of

concentrations as trophic order increases. In order to accurately determine the exact level of bioaccumulation in a given species, site specific testing is necessary.

4.3 Fertilizers as Water Pollutants

The most significant agriculturally produced water contaminant in the U.S. is nitrate. Nitrate pollution comes from nitrogen runoff primarily from animal manures, atmospheric deposition, commercial fertilizers, and the conversion of unmanaged land to intensive agriculture. The rate of nitrogen added to the terrestrial environment over the last 30 years has nearly doubled due to human alterations of the nitrogen cycle.³⁰⁰

The over application of nitrogen fertilizers and the excess build up of nitrogen in soil lead to the increased transport of nitrogen away from fields and into local waterways. Nitrogen from any application, including synthetic fertilizers, manure, and legumes, contributes to nutrient-rich waters through runoff. Studies show that runoff from synthetic fertilizers is the most prevalent source of downstream nitrogen.³⁰¹ Over-tilling further increases nitrogen losses by releasing stored nitrogen from the soil.³⁰² In some cases, 20 percent of the nitrogen fertilizer applied to a field is leached from the soil because of poor soil structure. This not only impacts the downstream environment by causing algal blooms and aquatic dead zones, but also is a significant cost to the farmers who lose 20 percent of their fertilizer purchase.³⁰³

The Colorado Department of Agriculture (CDA), in alignment with the Groundwater Protection Act, has monitored groundwater quality across Colorado for over 15 years. In a report assessing the impact of agricultural chemicals on groundwater from 1990 to 2006, the CDA continuously evaluated 40 wells in the Front-Range Urban Corridor. Twelve percent of the wells were found with levels of nitrate exceeding the allowable EPA maximum concentration level of 10 mg per liter for drinking water, with only 20 percent of wells testing below the detection limit (BDL).^{305, 306} Nitrate was detected in 68 percent of the remaining wells but at levels below the EPA maximum concentration level (Graph 5). Nitrate is a potential human health threat especially to infants because it causes the condition known as methemoglobinemia, also called "blue baby syndrome."^{307, 308}

Graph 5: Nitrate Levels from Sampled Groundwater in the Front Range³⁰⁴

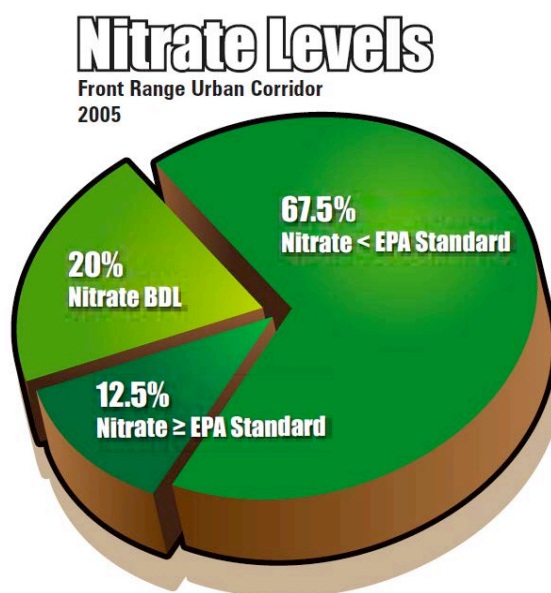

Nitrogen runoff can be minimized with water-control structures that are designed to slow water flow. Examples of water-control structures include contour tillage, diversions, terraces, and sediment ponds. When water-control structures were installed on

approximately 200,000 acres of agricultural land in eastern North Carolina, they reduced nitrogen runoff by over one million pounds per year.³⁰⁹

Eutrophication

An increased concentration of nutrients, especially phosphorus and nitrate, in a body of water is known as eutrophication.³¹⁰ Eutrophication, whether from natural or anthropogenic causes, can lead to extremely high rates of plant and organic matter growth, known as algal blooms. When large algal biomass builds during blooms, transparency decreases and the metabolism and decomposition of the algae depletes available oxygen, often to stressful and even lethal levels.³¹¹ Eutrophication is a concern in many waterways because it typically leads to the death, via suffocation, of higher trophic level aquatic organisms such as fish.³¹² In addition to these ecological effects, eutrophication can also present water quality concerns for municipal water supplies.

According to the Colorado Water Resources Research Institute, most of the reservoirs along the Colorado Front Range have rates of eutrophication that are a cause for concern.³¹³ While increased levels of nutrients in irrigation water may be advantageous for farmers since they help reduce the need for fertilizers, they also present a multitude of problems for managers of municipal drinking water. The algal blooms clog intake filters, contribute taste and odor to treated drinking water, and cause elevated levels of total organic carbon (TOC), which when treated with disinfectants like chlorine, can produce harmful disinfection by-products.^{314, 315}

The majority of the reservoirs in the Front Range are phosphorus limited for most of the year with nitrogen limitation later in the summer, making them very sensitive to eutrophication.³¹⁶ When runoff from recently or over fertilized and manured agricultural lands delivers large amounts of nitrogen and phosphorus to water bodies that are nutrient limited, high rates of eutrophication typically occur.³¹⁷

4.4 Pesticides as Water Pollutants

Controlling crop pests like weeds, insects, and diseases can be a significant investment for agricultural operations. Pesticides, including herbicides, fungicides, and insecticides, not only have significant financial impacts, but also major implications for water and soil quality.³¹⁸

Pesticides have been detected in more than 90 percent of the wells sampled in urban and agricultural areas of the South Platte River Basin in northeast Colorado, which includes Boulder County.³¹⁹ The most commonly detected pesticide was atrazine, which was found in roughly 61 percent of the wells sampled in the South Platte River Basin and almost 30 percent of the wells tested in Colorado (Graph 6). Alachlor, metalachlor, and simazine were also detected in the South Platte River Basin but not Colorado as a whole.³²⁰ While the types of pesticides detected in the basin were similar to those found across the U.S.,³²¹ the frequency of pesticide detections place the area in the highest 25 percent of all basins tested nationally.³²²

The most commonly used herbicide, glyphosate was not found in the wells sampled. Glyphosate is highly adsorbed on soils especially those with high organic content, making leaching very unlikely due to the compounds strong attachment to soil.³²³ An estimate of glyphosate loss showed that less than two percent of the applied chemical was lost to runoff.³²⁴ While the loss of glyphosate is minimal, it can be broken down into more water-soluble forms by microbes, however, the time it takes for half of the product to break down ranges from one to 174 days.³²⁵

Graph 6: Statewide Detection of Pesticides in Groundwater (Colorado)³²⁶

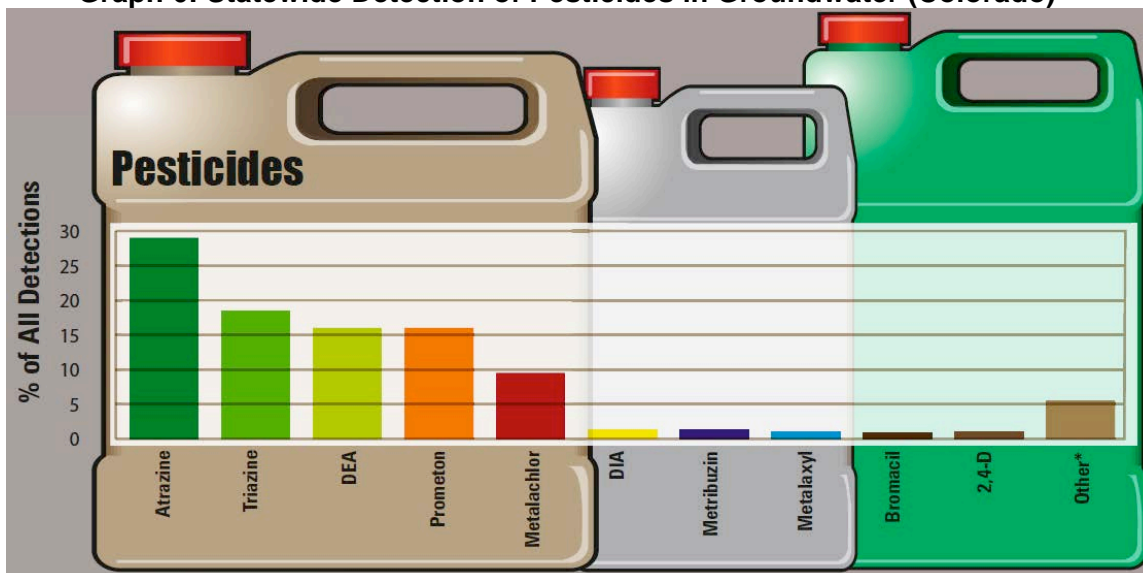

The concentrations and total number of pesticides detected in Colorado groundwater are typically higher during the growing season (April-September), with the highest concentrations occurring soon after application periods. Applications generally occur before or early in the growing season (March-May) and in the middle of the growing season (June-July). Additionally, pesticides have been detected year-round at low concentrations in areas regardless of season or streamflow volume, potentially indicating pesticides can persist long-term in shallow alluvial aquifers.³²⁷

Although terrestrial impacts of pesticides do occur, the main impacts to ecological systems are through water contaminated by pesticide runoff. The specific impacts of pesticide use on the environment and living organisms are difficult to assess, however, there are two principal mechanisms that cause negative impacts: **bioconcentration** and **biomagnifications**.

Bioconcentration is the movement of a chemical from the surrounding medium into an organism such that higher concentrations occur within the organism.³²⁸ The primary "sink" for some pesticides is fatty tissue, which is a type of lipid. Some pesticides, such as the banned insecticide DDT, are "lipophilic," meaning that they are soluble and accumulate in fatty tissue, such as edible fish tissue and human fatty tissue. Other pesticides, such as **glyphosate** (the active ingredient in Roundup and other commercial brands), are metabolized and excreted.

Biomagnification is the increasing concentration of a chemical as it is transferred up through the food chain. As smaller organisms are eaten by larger organisms the concentration of pesticides and other chemicals are increasingly magnified in tissues and other organs. Very high concentrations can be observed in top predators, including man.

The effects of pesticides in the environment vary depending on both the organism, the concentration, and the pesticide in question, but general effects may include the following:³²⁹

- Death of the organism
- Cellular and DNA damage
- Cancers, tumors, and lesions on fish and animals
- Reproductive inhibition or failure
- Suppression of immune system
- Disruption of endocrine (hormonal) system
- **Teratogenic** effects (physical deformities such as hooked beaks on birds)
- Poor fish health (marked by low red to white blood cell ratio, excessive slime on fish scales and gills, etc.)
- Intergenerational effects (effects are not apparent until subsequent generations of the organism)
- Other physiological effects such as eggshell thinning

These effects are not necessarily caused solely by exposure to pesticides or other organic contaminants and may be associated with a combination of environmental stresses on organisms such as eutrophication and pathogens. Most of these impacts are chronic so they are not noticed by casual observers, but have consequences for the entire food chain.³³⁰

5. Soil Health

Summary

There are 23 main soil combinations in Boulder County that sustain a variety of crops, livestock, native grasslands, shrublands, wetlands, and forests, serving important functions for both plants and animals. The quality, yield, and viability of agricultural crops are directly dependent upon a healthy and fertile soil. Improving soil quality is considered to be a key element of a **sustainable agriculture** production system. Much of the early research on soil health focused primarily on soil's capacity for crop production, while other factors, such as structure, carbon sequestration, and biodiversity, were either not considered or were accorded secondary importance. Recently, awareness has been increasing about how environmental factors interact and impact economic sustainability.

Reduction of soil quality is a growing concern, particularly since anthropogenic soil degradation has been reported on almost 40 percent of the world's agricultural lands. Reasons for this soil degradation include increased erosion, atmospheric pollution, extensive soil cultivation, over-grazing, land clearing, salinization, and **desertification**.

The primary agricultural practices identified in the literature that strongly affect soil health positively or negatively include tillage method, soil amendments, soil conservation, grazing practices, and crop rotation. One of the most important aspects of healthy soils is the organic matter content, which is heavily influenced by these farm practices. Most soils in Colorado have low amounts of organic matter, containing less than 1.5 percent. Methods such as cover crops and **green manures** can serve as organic material sources for agricultural systems, helping to decrease the potential for soil erosion, while improving soil **tillth**, water-holding capacity, stability, and structure. The use of cover crops and green manures needs to be evaluated on both environmental and economic conditions, as a number of factors can affect their financial viability.

Conservation tillage methods were identified as one of the most important factors for building healthy and fertile soil. Methods of conservation tillage were strongly associated with increasing the amount of soil organic matter, nutrient availability, and erosion resistance. While there were many benefits associated with conservation tillage, two main concerns were raised regarding economic viability and the increased use of synthetic nitrogen fertilizers. A study conducted in the Fort Collins area concluded that a conservation tillage system required more nitrogen fertilizer than conventional tillage to produce equal yields, but less irrigation and machinery were necessary. A similar study found comparable results and showed that on irrigated continuous corn, no-till was actually more profitable than conventional-till because of lower machinery and labor costs as well as a decrease in fossil fuel use.

These results highlighted that conservation tillage methods are crucial for improving and maintaining soil health and can be done at a profit. In multiple studies it was noted, however, that ultimately, farmers and landowners should be the ones to decide which soil management practices should be implemented because soil type is specific to each location.

5.1 Overview of Soils in Boulder County

Improving soil quality is considered to be a key element of a sustainable agriculture production system since soil quality often directly and indirectly influences a variety of other farm practices.³³¹ In agriculture, soil has three principal functions of significance; it is a medium for crop and biological production, a buffer or filter to mitigate environmental contaminants and pathogens, and a promoter of plant, animal, and ultimately human health. The functions of soil quality, as they relate to sustaining crop production, improving land management, and the quality of the agricultural ecosystem, are best evaluated at the local farm and field level.³³²

There are 23 main soil combinations in Boulder County that sustain a variety of native grasslands, shrublands, wetlands, and forests, serving important functions for both plants and animals.³³³ Together, these soils also support a variety of land uses including agricultural croplands, livestock grazing lands, and recreational opportunities.³³⁴

5.2 Soil Conservation

Top soil has been reduced and its quality has been degraded worldwide due to past mismanagement of agricultural land and other ecosystems.^{335, 336, 337} Heavy mechanical cultivation and the continuous production of row crops have resulted in soil displacement through erosion and significant decreases in soil organic matter content.^{338, 339} Healthy soil is key to reducing its susceptibility to erosion and other processes that lead to soil loss. As highlighted by the United States Department of Agriculture (USDA), management tools such as tillage, fertilizer, livestock, and pesticides can be used to improve soil health, however, they can significantly damage the physical, chemical, and biological properties of soil if they are not applied correctly.³⁴⁰ Common practices for preserving or increasing soil quantity include minimizing soil disturbance, keeping the soil covered, maintaining suitable habitat for biological activity, and building soil organic matter.³⁴¹

Soil Erosion

Soil erosion has detrimental effects on soil productivity, reducing the ability of soil to buffer and filter pollutants, manage nutrient and chemical cycles, and provide adequate habitat to support plants.^{342, 343} Soil erosion is a complex process influenced by multiple factors, including soil properties, ground slope, vegetation, land use, and rainfall.³⁴⁴ Changes in land use, such as conversion of native grasslands to agriculture or livestock grazing, are widely recognized as capable of greatly accelerating soil erosion. If soil erosion rates are in excess of soil production, agricultural potential and productivity will eventually decrease.^{345, 346}

Some estimates have placed topsoil erosion in the U.S. at a rate ten times greater than topsoil production. The two biggest contributors to the loss of fertile topsoil on agricultural lands are wind and water erosion, representing about 84 percent (Graph 7).^{347, 348} Wind is the primary soil erosion force in Boulder County.

Graph 7: Common Causes of Soil Degradation on Agricultural Lands in the U.S.³⁴⁹

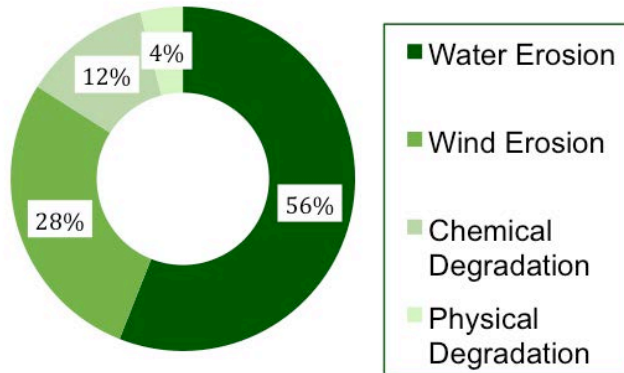

When topsoil is eroded, 50-75 percent of the decrease in soil productivity is due to the soil’s loss of nutrients and organic matter, and consequently, its water-holding capacity.³⁵⁰ Soil removed by erosion typically contains about three times more nutrients than the soil left behind and is 1.5 to 5 times richer in organic matter.³⁵¹ When water and wind erosion occurs at a rate of 7.6 tons/acre/year it costs \$40/acre/year to replace the lost nutrients with fertilizer, and around \$17/acre/year to pump irrigation water to make up for the decreased water holding capacity of that soil.³⁵² According to the USDA Natural Resource Conservation Services, erosion-caused losses in productivity on pastureland and cropland in the U.S. are approaching \$27 billion per year in 1999 dollars.³⁵³

Figure 18: Potential Soil Erosion Due to Wind and Water in Boulder County³⁵⁴

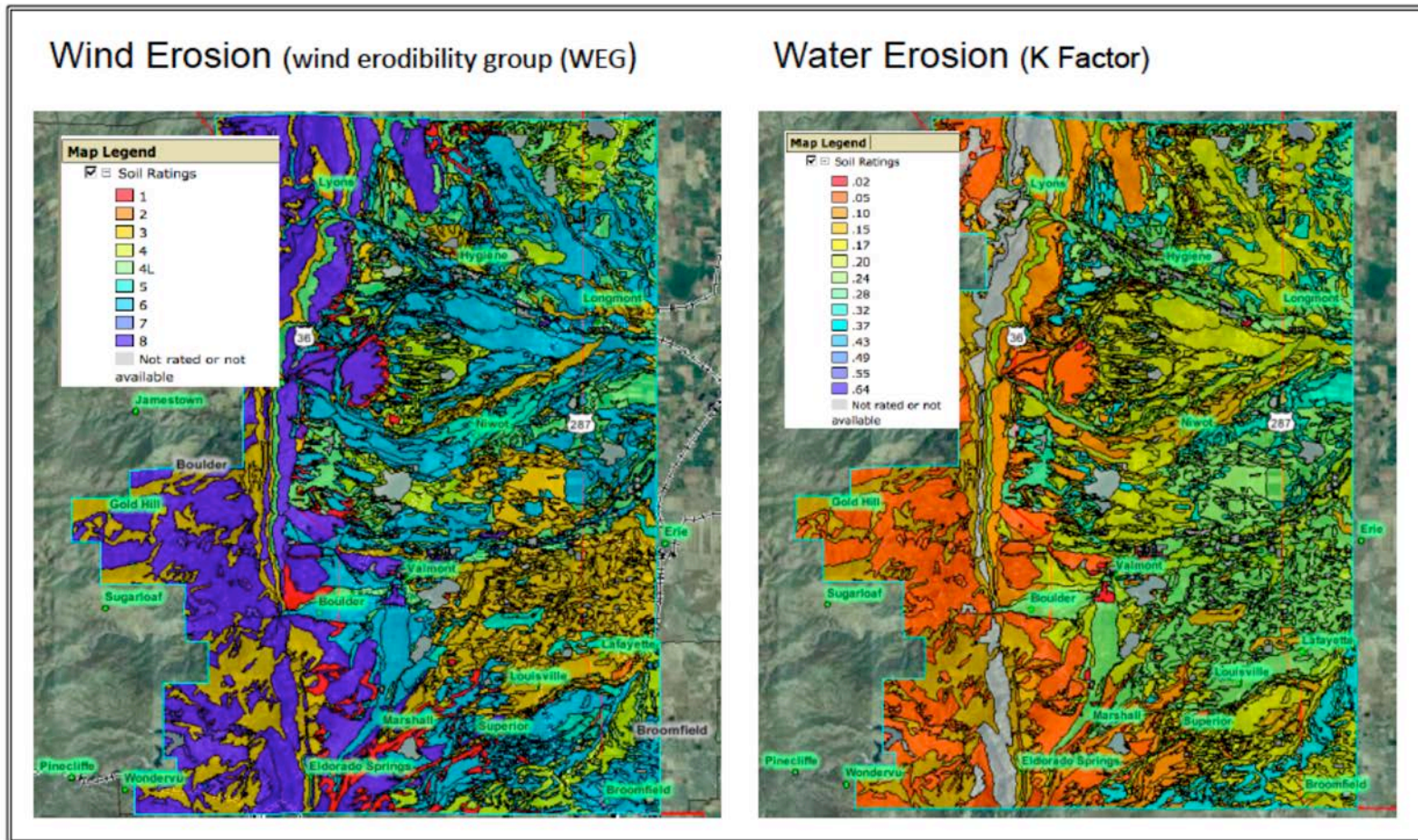

Wind Erosion: Soil ratings progress from 1 – the most susceptible to wind erosion, to 8 – the least susceptible to wind erosion.
Water Erosion: Soil ratings progress from 0.02 – least susceptible to water erosion, to 0.69 – most susceptible to water erosion.
 Water erosion pertains to sheet and rill erosion

Agricultural systems in Boulder County are particularly prone to erosion because of frequent high winds. Areas in Boulder County where vegetation has been removed, for example annual cropland, overgrazed areas, and burn areas, are even more exposed and vulnerable to wind erosion than sheltered lands.³⁵⁵ Certain farming practices, such as **stubble mulch**, reduced tillage, no-tillage, **strip cropping**, leaving a rough tilled soil surface, and treatment of exposed areas by re-seeding and planting can help to reduce the extent of both wind and water erosion on cropping and grazing systems.

Tillage Methods

There are two general types of tilling practices, conventional-till or intensive-till and conservation-till. Conventional-till plows all residues from the prior harvest into the soil, as opposed to conservation-till, which leaves at least 30 percent of the crop residue on the surface undisturbed. No-till leaves all crop residue and does not till at all before planting the following crop.³⁵⁶ According to the Conservation Technology Information Center, in 2008, conservation tillage methods totaled 113,764,677 acres in the U.S., intensive-till totaled 101,339,774 acres, while all other tillage methods totaled only 58,983,025 acres.³⁵⁷

Soil erosion is the main concern with the use of intensive tillage practices. To avoid erosion, farmers may employ conservation tillage, which is broadly defined as any tillage method that leaves sufficient crop residue in place to cover the soil surface.³⁵⁸

The benefits of conservation tillage include:³⁵⁹

- Reduced wind erosion
- Improved soil moisture management
- Increased carbon sequestration
- Reduced water erosion
- Increased options for multiple cropping
- Improved soil structure
- Weed suppression
- Reduction of the volatilization of organic matter from tillage

The benefits of higher carbon sequestration rates go beyond reducing carbon dioxide emissions. Higher levels of soil organic carbon (SOC) actually help bind the soil particles together causing the near surface soil to be more stable and less susceptible to water erosion. Raindrops can be more erosive than runoff or flowing water because they have a higher velocity, particularly in arid locations. High levels of SOC are important in areas where annual precipitation is low and evaporation is high, such as the Great Plains, to decrease erosion. A study conducted in the Great Plains region, including a site in Akron, Colorado, concluded that under no-till soil practices, the increase in SOC content was “partly responsible for the greater aggregate water repellency, stability, and resistance to raindrops.”³⁶⁰

No-till is a type of conservation agriculture and is a growing trend according to the USDA.³⁶¹ No-till can be used on almost any crop. Beyond protecting soil from erosion, increasing water retention,³⁶² and decreasing energy use, no-till agriculture can also increase the soil's ability to absorb carbon, decreasing carbon dioxide in the atmosphere.³⁶³ No-till practices can also decrease farmer's fuel costs. The USDA Natural Resources Conservation Service estimates that a farmer can save 3.5 gallons of fuel per acre by changing from conventional-till methods to no-till.³⁶⁴



A long-term study of cereal crop production in the Northern Great Plains region found that a zero-tillage management system had greater soil water retention than conventional tillage during a six-year drought period. Mean crop biomass in the zero-tillage system was 53-66 percent greater than the conventional system. Furthermore, the amounts of carbon and nitrogen in the soil surface residues were 23-141 percent greater than in the conventional tillage system.³⁶⁵

While there are many soil benefits to conservation tillage practices, like no-till agriculture, there are two main concerns: economic viability and the increased use of nitrogen fertilizers. No-till farming methods have been reported to produce lower total yields compared to conventional-till methods when nitrogen levels are comparable. A study conducted outside of Fort Collins, Colorado, attempted to fill the information gap on the economic effect of conventional-till versus no-till systems. The study concluded that a no-till system required more nitrogen fertilizer to produce equal yields, but less irrigation and machinery were necessary.³⁶⁶ A study done in Southwest Colorado and Southeast Utah had similar findings; minimal-till and no-till methods increased water storage in the soil, but also relied more on fertilizers. While conventional-till methods produced higher yields for corn in this study, they cost more to produce.³⁶⁷

Although organic farming has been shown to supply high organic matter inputs to soil with reduced reliance on synthetic fertilizers and pesticides, the high reliance on tillage for organic production can reduce soil and water conservation through erosion and compaction.³⁶⁸ The common use of synthetic fertilizers and pesticides in conservation tillage is not an option for organic farmers,³⁶⁹ making some organic farmers more cautious than conventional growers to implement conservation tillage as it would limit using tillage as a management method for weeds and cover crops.³⁷⁰ A study evaluating the suitability of conservation tillage for organic agriculture found multiple tradeoffs including:³⁷¹

Potential advantages:

- Reduced erosion
- Increased microbial activity and carbon storage
- Less run-off and leaching of nutrients
- Reduced fuel use and faster tillage

Potential disadvantages:

- Greater pressure from grass weeds
- Less suitable than ploughing for poorly drained, unstable soils
- Restricted N availability and restricted crop choice

The authors of the study found that the success of conservation tillage in organic farming hinges on the choice of crop rotation to ensure weed and disease control and nitrogen availability, and acknowledged that additional research is needed to further evaluate conservation tillage in organic agriculture.

A recent study conducted by National Resource Conservation Service (NRCS) in Colorado looked at the economic viability of using strip tillage for sugar beets in the Front Range of Colorado. The study found that yields were less than traditional sugar beet tillage, but net profit was higher. During the study, NRCS found that strip tillage for sugar beets is a new concept in Colorado, as there is a “belief that sugar beets would only grow from a fine tilled seedbed.” NRCS’s “final conclusion from observations on the project is that a producer should do several years of strip till corn before going to strip till sugar beets to learn the system.”³⁷²



Graph 8: Irrigated Continuous Corn Grain Yields in Comparison to Nitrogen Fertilizer Rates for Conventional-till and No-till Farming, 2000-2004³⁷³

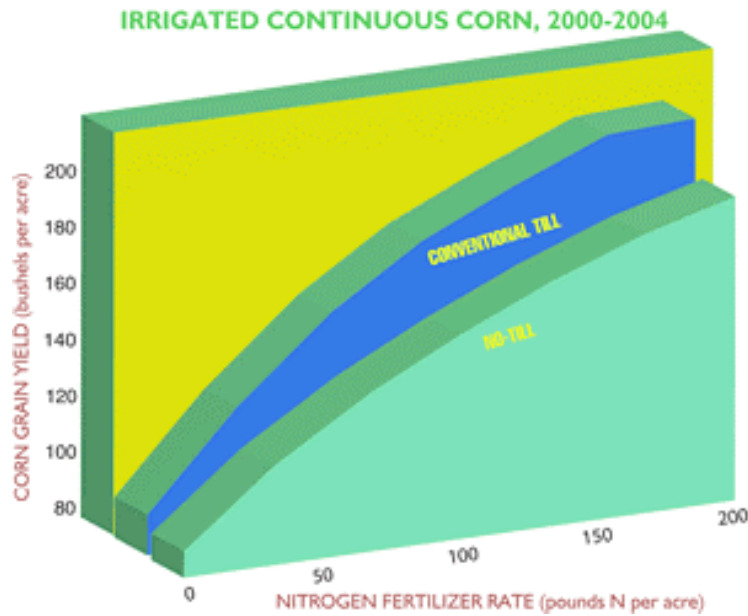

David Archer, an Agricultural Research Service economist, found no-till was more profitable than conventional-till on irrigated continuous corn crops because of lower machinery and labor costs, as well as a decrease in fossil fuel use. While Graph 8 shows higher yields (crop production) for conventional-till agriculture when nitrogen fertilizer rates are equal, Graph 9 demonstrates that no-till farming earns higher net returns (financial income) when nitrogen fertilizer rates are equal.³⁷⁴ Comparing the data from the two charts, as nitrogen fertilizer rates stay constant, no-till farming earns higher net returns even with lower yields. Additionally, future water supply issues could prove no-till farming to be the more desired method since it tends to need less irrigation.³⁷⁵

Graph 9: Irrigated Continuous Corn Net Returns in Comparison to Nitrogen Fertilizer Rates for Conventional-till and No-till Farming, 2000-2005³⁷⁶

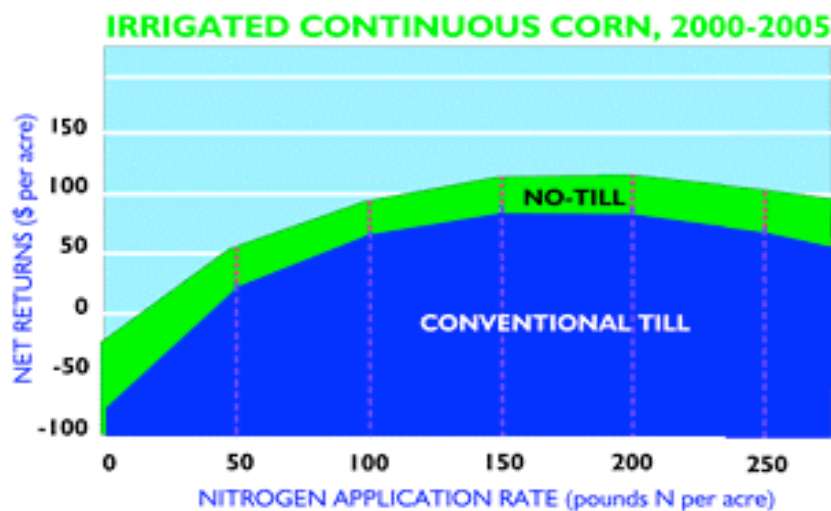

There are some tillage methods that are a combination of conventional-till and no-till, such as ridge-till, mulch-till, and reduced-till. Both ridge-till and mulch-till are considered conservation-till methods because they leave greater than 30 percent of past crop residue on the land, however, reduced-till methods only leave 15 to 30 percent of crop residue and thus are not considered conservation-till.

Ridge tillage consists of maintaining – permanent or semi-permanent – artificially created ridge beds across an entire field. The ridge beds are established and maintained through the use of specialized cultivators and planters designed to work with heavy crop residues. The primary focus of ridge tillage is on row crops such as corn, soybeans, and cotton.³⁷⁷ In contrast to most forms of mulch tillage, more crop residue remains on the soil surface for a greater portion of the season.

Mulch tillage is full-width tillage, meaning that all of the soil surface is disturbed, and is done prior to and or during planting. Although some crop residue is left on the soil surface, at least 30 percent of the soil surface is disturbed. Some examples of mulch tillage are aerways, rotary harrows, and turbo tills. Some advantages of mulch tillage practices are that it creates moderate erosion control and it helps the soil retain moisture.³⁷⁸

Soil that is not affected by erosion is considered stable soil. This typically occurs when the topsoil and the subsurface soil are very similar. When there is a slight difference in soil qualities between the topsoil and subsurface soil, causing it to erode initially but then stabilize, it is considered **neutral soil**. Finally, when the subsurface soil below a good layer of topsoil is poor in quality, causing erosion to be much more likely, the soil is considered to be **susceptible soil**. Conventional-till agricultural practices, typically associated with high levels of erosion, can be used if the soil is considered stable soil.³⁷⁹ The negative effects of conventional-till on neutral soil and susceptible soil systems are greater than on stable soil systems.

Grazing Practices and Crop Rotation

Boulder County has historically been a grassland region, however, only about 15 percent of the original grasslands remain because of an increase in irrigated cropland, development, and recreation.³⁸⁰ Due to this decrease in the abundance of grasslands, grazing practices have an important impact on the surrounding systems. Not only do native grasses provide food to livestock, but they also protect soils from wind and water erosion, sequester carbon, keep watersheds below grazing areas clean,³⁸¹ and increase soil water infiltration.

Grazing frequency intensity and timing (seasonality) influence how grasses respond to grazing practices.³⁸² Proper grazing strategies allow grasses to recover, however, there is no umbrella grazing strategy since the proper time to move livestock from one area to another is based on the amount of green leaf material left in the grass.³⁸³ Grazing can also affect the water infiltration rates of soil. A study conducted near Nunn, CO, compared the infiltration rates of three different soil types at three different grazing levels. The three types of soils studied were Ascalon sandy loam, Shingle sandy loam, and Nunn loam. On areas with the three soil types, three grazing rates were used: light, moderate, and heavy. To test the infiltration rates, rainfall was simulated and the difference between application and runoff rates were calculated. It was concluded that



moderate grazing is optimal on all three of the soil types. This study only addressed infiltration rates of soils in association with grazing practices; therefore, conclusions cannot be drawn about how grazing affects other soils and processes such as water pollution concerns.³⁸⁴

The USDA and Natural Resources Conservation Service recommend protecting grasslands by using deferred grazing methods in the Boulder area. Deferred grazing enables the pasture or rangeland to rest during the growing season, increasing the physical strength of the grass and allowing it to reproduce naturally. Deferred grazing can help maximize the amount of forage in a given area, providing the greatest value to the livestock.³⁸⁵

Crop rotation is the practice of rotating crops on a given plot of land, whether that is a rotation of high residue with low residue crops, or a rotation of field crops with forage crops. The effects of crop rotation can vary greatly because of the many variables involved, including type of soil, type of crop, management of crop residue, and general farming practices. Although the benefits of crop rotation can vary, the possible benefits include:³⁸⁶

- Increased organic matter
- Reduced soil erosion
- Improved pest management
- Break weed cycles
- Reduced runoff and erosion
- Improved soil tilth
- Better moisture efficiency
- Higher yields
- Improved aesthetics and wildlife habitat

For more information on crop rotation and pest management, see section *7.4 Integrated Pest Management*.

5.3 Organic Matter, Cover Crops, and Green Manures

Soil organic matter and **humus** have been found to create a healthy and fertile soil structure.³⁸⁷ Most soils in Colorado have low amounts of organic matter, containing less than 1.5 percent.³⁸⁸ Soils containing higher percentages of organic matter or humus are better able to retain water and nutrients and resist erosion. Cover crops and green manures can serve as organic material sources for agricultural systems, helping to decrease the potential for soil erosion while improving soil tilth, water-holding capacity, stability, and structure.^{389, 390}

A cover crop is any crop that is grown to provide soil cover mainly for the purpose of reducing wind and water erosion. A green manure is any field or forage crop, including a cover crop, that is incorporated into the soil while the crop is still green or flowering. Cover crops and green manures can be annual, biennial, or perennial plants that grow in a pure or mixed stand during all or part of the year. In addition to providing ground cover they may also help suppress weeds and reduce diseases and insect pests.³⁹¹

Factors affecting the economics of cover crop use include:³⁹²

- The cash crop grown
- The cover crop selected
- Time and method of establishment
- Method of termination
- The non-market value applied to the environment, soil productivity, and soil protection benefits derived from the cover crop
- The cost of nitrogen fertilizer and the fertilizer value of the cover crop
- The cost of fuel

In the literature reviewed, there are three types of costs associated with using cover crops: direct, indirect, and opportunity costs. The direct costs are affected by the cost of seeds, water and energy, as well as nitrogen fertility dynamics in cover crop systems. Direct costs are typically associated with cover crop establishment and are particularly high for legumes. Studies state that the costs of establishment can be ten times higher for leguminous cover crops than for grasses because of large seed size, seed dispersal mechanisms, and the generally weak emergence of leguminous cover crops.³⁹³ However, the increased cost of the legume cover crop seed can be offset by the value of nitrogen that legumes can replace from other fertilizers.³⁹⁴ The cost of legume seeds is minor compared to the cost associated with delaying a main crop planting in order to plant cover crops, and is only practical in some cases.^{395, 396}

Another direct cost associated with cover crops and green manures is water use. Regardless of which tillage system is used, the risk of early-season soil water depletion by cover crops remains the same.³⁹⁷ Furthermore, moisture availability typically limits the use of cover crops in dryland systems. A literature review of dryland cover crop studies on the Great Plains found that the use of cover crops on dryland cropping systems reduced the yields of subsequent crops.³⁹⁸ One study found that

“Cover crops use soil water while they are growing. This can negatively affect cash crop yields. Once killed, however, cover crop residues may increase water availability by increasing infiltration and reducing evaporation losses. Short-term soil water depletion at planting may or may not be offset by soil water conservation later in the growing

season. This is dependent on rainfall distribution in relation to crop development.”³⁹⁹

Water consumption by a cover crop is a concern in areas with less than 30 inches of precipitation per year, like Boulder County.⁴⁰⁰ Additionally, turning green manure into the soil requires additional time (labor) and energy expense, compared to not planting a cover crop.⁴⁰¹

The indirect on-farm costs include hindering the establishment of the succeeding cash crop and cover crop management problems that impede realization of the expected benefits (i.e. over-vigorous cover crops that are hard to kill or incorporate).⁴⁰² Some of these potential disadvantages are highlighted in Figure 19. Also, cover crops have been shown to harbor insects, diseases, and nematodes that could be harmful to a cash crop, but conversely, have been used in conservation tillage systems to attract beneficial insects. Understanding these specific crop and pest interactions can be complex and is best evaluated at individual farms.^{403, 404} For additional information see *Pest Management*.

Figure 19: Potential Disadvantages of Cover Crops⁴⁰⁵

POTENTIAL DISADVANTAGES

Species	Increase Pest Risks			Management Challenges				
	weed op/territial	insects/ nematodes	crop disease	hinder crops	establish	till-kill	mow-kill	mature incorp.
Barley	◐	◐	◐	◐	●	●	●	○
Oats	●	◐	◐	◐	●	●	◐	◐
Rye ¹	◐	◐	◐	◐	◐	◐	●	○
Wheat	◐	◐	◐	◐	●	●	◐	◐
Buckwheat	○	◐	●	●	●	●	●	●
Crimson clover	◐	○	◐	●	◐	◐	◐	◐
Field peas	●	◐	◐	●	●	●	●	◐
Hairy vetch	◐	◐	●	●	◐	◐	●	◐
Medics	◐	◐	●	◐	◐	◐	◐	◐
Red clover	◐	◐	◐	●	◐	◐	◐	◐
Sweetclovers	◐	◐	●	◐	●	◐	◐	◐
White clover	◐	◐	◐	◐	◐	○	◐	◐

○ = problem. ◐ = Could be a moderate problem. ◑ = Could be a minor problem.
 ◒ = Occasionally a minor problem. ● = not a problem

1. Rye can act as a weed in Boulder County so other options may be more appropriate.

Opportunity costs of income forgone by planting a cover crop instead of cash crops may be the highest costs associated with cover crops. For this reason, cover crops are rarely grown when cash crop alternatives are possible.⁴⁰⁶ Spring soil temperature is particularly important in cover crop and conservation tillage systems. Cover crop residues keep the soil cooler, which benefits the cash crops throughout the summer, but can delay spring planting compared to a system without a cover crop because soil temperatures need to be warmer. This was shown in a study conducted in Northern Colorado, where reduced corn yields were reported for no-till compared to conventional tillage within a continuous corn production system due to cooler soil temperatures and slower plant development in the no-till system.^{407, 408}



The cost of seed usually can be recouped in the short-term by the reduced need for expensive nitrogen fertilizers and in the long-term by building and maintaining soil organic matter.⁴⁰⁹ Cover crops and green manures help to cycle soil nutrients such as phosphorus, potassium, calcium, magnesium, sulfur, and nitrogen. When green manure is incorporated into the soil or left down as no-till mulch, these plant-essential nutrients become available during decomposition, providing long-term soil nutrients.⁴¹⁰

Figure 20: Potential Advantages of Cover Crops⁴¹¹

POTENTIAL ADVANTAGES

Species	Soil Impact			Soil Ecology				Other		
	subsoiler	free P&K	loosen topsoil	nematodes	disease	allelopathic	choke weeds	attract beneficials	bears traffic	short windows
Barley <i>p. 77</i>	◐	◐	◑	◐	◐	◑	◑	◐	◐	●
Oats <i>p. 93</i>	○	◐	◑	○	◐	◑	●	○	◐	●
Rye <i>p. 98</i>	◐	◑	●	◐	◑	●	●	◐	◑	●
Wheat <i>p. 111</i>	◐	◑	◑	◐	◐	◐	◑	◐	◐	◐
Buckwheat <i>p. 90</i>	○	●	◑	◐	○	◑	●	●	○	●
Sorghum-sudangrass <i>p. 106</i>	●	◐	◐	◑	◑	●	●	◐	◐	●
Crimson clover <i>p. 130</i>	◐	◐	◐	◐	◐	◐	◐	◑	◐	◐
Field peas <i>p. 135</i>	◐	◐	◑	◐	◑	◐	◑	◑	◐	◑
Hairy vetch <i>p. 142</i>	◐	◐	◑	◐	◐	◐	◑	●	○	○
Medics <i>p. 152</i>	◐	◐	◐	◐	◐	◐	◑	◐	◐	●
Red clover <i>p. 159</i>	◑	◑	◐	◐	◐	◐	◐	◑	◐	◐
Sweetclovers <i>p. 171</i>	●	●	●	◐	◐	◐	◐	◑	◐	○
White clover <i>p. 179</i>	◐	◐	◑	○	○	◐	◑	◐	●	◐

○ = Poor; ◐ = Fair; ◑ = Good; ◒ = Very Good; ● = Excellent



The most effective cover and green manure crops are legumes, which are nitrogen-fixing plants.⁴¹² Common legumes include: peas, beans, alfalfa, clover, and vetch.⁴¹³ Nitrogen production from legumes is a key benefit of growing cover crops and green manures. Estimates of nitrogen accumulations by leguminous cover crops range from 40 to 200 pounds of nitrogen per acre, with 50 percent of the nitrogen accumulations available in the first year.⁴¹⁴ Cultural and environmental conditions, such as a delayed planting date, poor stand establishment, limits of irrigation water available, and drought, limit legume growth and reduce the amount of nitrogen produced. Conditions that encourage good nitrogen production include optimum soil nutrient levels, soil pH, and adequate soil moisture. Typical nitrogen yields from a variety of common legumes are presented in Figure 21.

Figure 21: Average Biomass and Nitrogen Yields from Sample Legumes⁴¹⁵

Cover Crop	Biomass tons/acre	Nitrogen lbs/acre
Sweet Clover	1.75	120
Berseem Clover	1.10	70
Crimson Clover	1.40	100
Hairy Vetch	1.75	110

Alfalfa is a cool season leguminous plant noted for improving soil tilth and having a higher potential yield than any other forage crop in Colorado. It is also known for being drought tolerant and adapted to growing at higher elevations.⁴¹⁶ Alfalfa can be rotated with grain and seed crops to increase yield. Much of this increase can be attributed to the nitrogen-fixing ability of alfalfa, similar to other legumes.⁴¹⁷ The average lbs/acre of nitrogen yields for alfalfa ranges from a low of 44 lbs to a high of 308 lbs.⁴¹⁸ The impact on the nitrogen in the soil may be even greater when alfalfa is grazed instead of hayed because of nutrient recycling.⁴¹⁹ An additional benefit of rotating alfalfa is its ability to act as a **living mulch**, such as in an alfalfa-corn rotation. However, this can present challenges when the alfalfa is rotated with certain crops, such as soybeans, because they are slower growing and more susceptible to competition from living mulch.⁴²⁰

Bio-char

Additional soil nutrient inputs can come from livestock manure and **bio-char**. Bio-char is a charcoal rich in nutrients and organic carbon that is produced from partially burning biomass. The application of bio-char improves soil fertility by adding and retaining soil nutrients. Bio-char is more effective at retaining most nutrients and keeping them available to plants than other organic matter such as common leaf litter, compost, or manures.⁴²¹

Using bio-char can be complicated because its chemical composition needs to be closely matched to the soil to which it is applied. Therefore, using bio-char from local and regional settings will likely prove to be more effective than using bio-char that has traveled long distances. The majority of bio-char projects are small scale, but are increasingly considered as a local means of replenishing soil nutrients.



5.4 Soil Amendments

Soil amendments are instrumental to soil health management. Soil amendments are simply any material that is mixed into the soil, however, they do not imply that the material is helpful or harmful to soil health or plant growth. Organic soil amendments can either be organic material, such as compost and manure, or an organic fertilizer that does contain a certain guaranteed level of nutrients.⁴²² In Colorado, compost is considered a soil amendment even if it does not contain microorganisms. Fertilizer differs from compost because legally it must guarantee a certain level of nutrients. Technically, mulch is not considered a soil amendment because it is applied to the surface of the soil rather than mixed in. Selecting the best amendments to achieve the desired results, using amendments appropriately, not over-amending, and evaluating their productivity are all functions of managing soil health.⁴²³

Nitrogen Applications

One of the main problems associated with nitrogen fertilizer is that it is typically over applied. In many regions, the nitrogen levels in groundwater exceed EPA standards.⁴²⁴ The USDA conducted tests in Colorado's South Platte River Basin aquifer and found that in 70 percent of their test sites within ten miles of feedlots, nitrate levels were above EPA standards.⁴²⁵ This illustrates that manure and other nitrogen fertilizers can easily cause water pollution if they are not managed properly. For this reason, it is necessary that nitrogen fertilizers be efficiently used.⁴²⁶ Application rates for nitrogen fertilizers can be calculated using several different methods. In the Western Great Plains region, nitrogen algorithms using field productivity are generally used to decide the appropriate use of nitrogen.⁴²⁷ The effects of nitrogen over application are explained in more depth in section 4. *Water Pollution*.

Nitrous oxide emissions are primarily generated from synthetic fertilizer applications, excessive nitrogen applications, and nitrogen leaching.⁴²⁸ Nitrous oxide has a global warming potential of 310 – the impact of nitrous oxide is 310 times more severe than carbon dioxide – and is the largest contributor to agricultural GHG emissions.⁴²⁹ Excessive nitrogen applications can be mitigated with slow- or controlled-release synthetic fertilizers, manures, and/or legumes.^{430, 431} Nitrogen leaching and runoff can be prevented through erosion control using cover crops, reduced tillage, increased soil tilth, precision applications to coincide with crop usage, and improved irrigation management. In Boulder County, leaching losses are mostly due to furrow and flood irrigation.

Nitrous oxide is released from excess nitrogen applications that are not used by crops. All forms of nitrogen applications can contribute to nitrogen losses, but because legumes fix nitrogen from the atmosphere and fulfill remaining nitrogen needs using soil nitrogen, the primary contributor of excess nitrogen is synthetic nitrogen and, to a lesser degree, manure. About 50 percent of the nitrogen released from manure or legume crops becomes available to the plants in year one, and most of the remaining nitrogen is used to build up soil humus and improve overall soil fertility.⁴³² Similarly, the crop plants absorb about 50 percent of nitrogen contained within synthetic nitrogen fertilizers; but instead of the remaining nitrogen being used to build soil fertility, the nitrogen is released from the soil as nitrous oxide and runoff or leaching.^{433, 434} Using a slow- or controlled-release synthetic fertilizer, manure, and/or legumes can help to prevent excess nitrogen losses.^{435, 436}



Farmers can also prevent excess nitrogen application by utilizing precision agricultural practices and applying nitrogen directly to the plant root at the right time of year. Precision agriculture can increase the efficiency of applying fertilizer, which reduces fertilizer costs, but the economic viability of precision farming needs to be evaluated on a farm-by-farm basis. The economic benefits of precision agriculture depend on whether the realized increase in revenue is sufficient to cover the costs of the technology.⁴³⁷ When excess nitrogen is applied, non-legume cover crops can be planted following traditional growing cycles to take up any nitrogen that was leftover from the cash crops. Nitrogen availability and use can be improved with erosion control and reduced- or no-till practices. Planting cover crops on **fallow fields** prevents nitrogen and carbon loss from erosion and no-till practices reduce disturbance and destabilization of soils.⁴³⁸

Nitrogen fertilizers have varying effects on different crops because of differences in root systems. In a study done in the Arkansas Valley in Southwest Colorado, onions and corn were rotated to test these varying effects. Onions have shallow root systems; therefore, nitrogen fertilizers are more likely to leach in the groundwater, because less of the fertilizer is recovered by the crop. By rotating crops such as wheat or corn with onions, the alternate crop can help extract residual nitrogen. The study found that rotating crops can help recover some residual nitrogen; together, both crops recovered around 39 percent of the total nitrogen fertilizer. However, this does not solve the concern of groundwater contamination.⁴³⁹

Manure

Animal manure, especially solid and slurry manure, contains large amounts of organic matter. The continued application of manure can supply plant nutrients and slow down the depletion of soil organic matter.⁴⁴⁰ Manure organic matter can contribute to improved soil structure, resulting in improved water infiltration and greater water-holding capacity leading to decreased crop water stress, soil erosion, and increased nutrient retention. An extensive literature review of historical soil conservation experiment station data from 70 plot years at seven locations around the United States suggested that manure produced substantial reductions in soil erosion (13-77 percent) and runoff (1-68 percent).⁴⁴¹ While manure offers many benefits for soil health, it can also pose risks. Continuous over-application of manure can result in increased salinity, degradation of surface water from phosphorus runoff, or groundwater contamination by nitrates. Application of manure is best applied based upon crop nutrient needs determined by soil testing to ensure appropriate application rates.⁴⁴²

Typically, there are about 1,000,000 cattle at any one time in Colorado, with each 1,000-pound animal producing between 50 and 60 pounds of manure and urine per day. The nutrients in the manure excreted from these cattle have a fertilizer value of \$34.2 million annually in 2007 dollars.⁴⁴³ In Boulder County there are over 15,000 cattle, which produce roughly 381 tons of manure.⁴⁴⁴ Figure 22 shows the approximate nutrient content of manure and the projected value per ton in 2001 dollars.^{445, 446}

Figure 22: Approximate Nutrient Content of Various Types of Manure at the Time of Land Application⁴⁴⁷

Manure Type	Total N (lbs/ton)	P ₂ O ₅ (lbs/ton)	Value of N and P ₂ O ₅ (\$/ton)
Beef	23	24	\$13.60
Dairy	13	16	\$8.32
Sheep	29	26	\$16.04
Chicken	33	48	\$23.04
Turkey	27	20	\$13.84
Horse	19	14	\$9.72
Swine	10	9	\$5.54

Dollar value is based on \$0.32/lb for nitrogen and \$0.26/lb for phosphorus (P₂O₅).

There are three major costs associated with using manure in agriculture: loading, transporting, and land application. Each of these three activities can require its own equipment. Since livestock manure can be liquid, slurry, or solid, the cost of distribution varies. Solid manure can usually be hauled farther for a lower cost while liquid manure, which cannot be transported as easily, can be distributed locally with low cost irrigation systems relatively inexpensively. Average manure costs are difficult to estimate because of the dependence on location, type, and availability. Figure 23 illustrates the comparative costs of different types of manure, transportation, and land application.⁴⁴⁸

Figure 23: Manure Application and Distribution Costs⁴⁴⁹

Manure Type	Loading	Transportation	Land Application
Solid Manure			
Fresh	\$\$	\$\$	\$\$\$
Stockpiled	\$\$\$	\$\$	\$\$\$
Slurry Manure			
Tanker	\$	\$\$\$\$	\$\$\$
Dragline hose	\$	\$\$\$	\$\$
Liquid Manure			
Dragline hose	\$	\$\$\$	\$\$
Irrigation system	\$	\$	\$

Note: \$ indicate expense relative to other types of manure.



Although manure is an inexpensive source of phosphorus (P), the transportation of manure can significantly add to the final cost. For this reason, many feedlots and dairies in Colorado will provide manure at no cost, if the consumer covers the manure transportation. Both manure and composted manure are good sources of available phosphorus. Manure-based compost costs about \$30 per ton with some providers including transportation in that cost. When manure is digested by worms, known as **vermicompost**, the process reduces volume and adds additional microbial diversity. Vermicompost is more expensive than the other two manure-based amendments, and sells for about \$600 per ton.⁴⁵⁰

Researchers at the Michigan State University Extension attempted to quantify the cost comparison between manure and synthetic fertilizers. They estimated costs based on a corn-soybean rotation using commercial (synthetic) fertilizer and using manure supplemented with commercial (synthetic) fertilizer. They concluded that the combination of commercial (synthetic) fertilizer and manure is the most cost effective method of fertilization. The cost per acre, including the cost of application, for 4 years of commercial (synthetic) fertilizer is estimated to be \$298, while manure supplemented with commercial (synthetic) fertilizer for 4 years is \$205.⁴⁵¹

Biosolids, Phosphorus, and Saline soils

Biosolids are a good alternative to chemical nitrogen fertilizers. A study conducted by Colorado State University in eastern Adams County, CO, compared commercial fertilizers to biosolids on no-till dryland agrosystems. The researchers observed winter wheat-fallow (WF) and winter wheat-corn-fallow (WCF) crop rotations. No significant differences in yields were found in the wheat rotation. In the corn rotations, biosolids created higher grain protein in the corn crops. They also found that biosolids did not raise the levels of salinity compared to commercial fertilizer.⁴⁵²

Phosphorous fertilizer, unlike nitrogen fertilizer, poses less risk to groundwater pollution because it is not as soluble; therefore, it only affects surface water. Manure and sewer sludge biosolids are two forms of soil amendments that increase phosphorous in soil. Like most other soil amendments, to most efficiently use phosphorous fertilizers and avoid over-fertilization, frequent soil tests are necessary.⁴⁵³

In arid climates like Colorado, saline soils can present problems to plant growth. Saline soils occur when minerals are left in the soil after water evaporates. This accumulation of soluble salts in the root zones can stunt and weaken plants because they reduce water uptake. How crops are affected by salinity varies, depending on the type of crop. Management practices can help mitigate problems associated with saline soil. These include installing proper – possibly artificial – drainage systems, applying crop residue to soil surface to avoid evaporation, and managing irrigation frequency to maintain soil moisture.⁴⁵⁴

6. Inputs

Summary

In 2008, inputs (non-labor) totaled almost \$800 million for all agricultural operations in Colorado, representing a significant expenditure for farmers in the state compared to historical costs. The price of these inputs has been steadily increasing since the 1970s, especially for electricity, seeds, pesticides, and fertilizers. After fuel (diesel and gasoline), the highest expenditure of manufactured inputs in Colorado is for fertilizers, with synthetic nitrogen fertilizers representing the largest portion.

Overall, the cost of synthetic commercial fertilizer has been increasing due to the upward-trending price of natural gas, which is the main input in the production of the ammonia that is used to make all synthetic nitrogen fertilizers. Additionally, due to the increase in price of natural gas, a large number of ammonia plants have shut down in the U.S., increasing reliance on imported ammonia for synthetic fertilizers and raising concerns about increased costs to farmers. Future fertilizer prices are largely unknown, but are expected to continue to trend upward with rising energy costs.

As the price of synthetic fertilizers continues to increase, manure is becoming a more valuable and less expensive source of nitrogen fertilizer. Crop producers are increasingly buying manure from livestock producers or adding livestock to their crop operations so that they can incorporate manure into their practices. In 2007, 293 farms used synthetic fertilizers and soil conditioners on over 25,000 total acres in Boulder County, while 147 farms used manure as a fertilizer on just under 5,000 acres.

Non-manufactured nitrogen fertilizers are increasingly being used as a means to reduce vulnerability to the price changes in fossil fuels. The most common alternatives to non-manufactured nitrogen fertilizers identified include green manures and integrating livestock into crop production. These practices, combined with other techniques such as conservation tillage, have shown to greatly decrease the need for synthetic fertilizers by increasing nutrient efficiency and improving soil health.

One factor identified in the literature that has been responsible for driving up seed prices, which have increased 146 percent since 1999, has been the adoption of genetically engineered (GE) seeds. However, due to the high adoption rates of GE seeds, technological costs are expected to decrease allowing seed prices to remain more consistent for the future.

A noted concern regarding GE seeds is the issue of **cross-pollination**, which can significantly impact the potential inputs in other non-GE crop systems if not managed correctly. In the literature reviewed there is no debate that cross-pollination can and does happen in all types of agriculture, including GE to non-GE crops. Concern of pollen drift in Boulder County prompted a study to determine the necessary buffers needed to limit cross-pollination in corn.

6.1 Agricultural Use of Inputs

The total cost of farm production in Colorado was 4.5 billion dollars in 2008,⁴⁵⁵ much of which can be attributed to the high costs of inputs. Agriculture inputs include energy, capital, labor, and manufactured inputs, which include fertilizers and lime, pesticides, fossil fuels and electricity. Seed, fertilizer, and pesticide costs have been increasing since 1970 (Graph 10).⁴⁵⁶ Seed prices have risen over time with the adoption of genetically engineered seeds. Since 1999, prices for seeds have risen 146 percent, but are forecasted to remain more consistent because of high adoption rates of GE seeds. The future of fertilizer prices is unknown in the long-term because they are derived from natural gas and rely on fossil fuels and electricity for production and transportation.⁴⁵⁷ Agriculture production type is another contributing factor to the total production cost because it determines the amount and types of inputs used.⁴⁵⁸

Graph 10: Increasing Cost of Inputs in U.S. Agriculture⁴⁵⁹

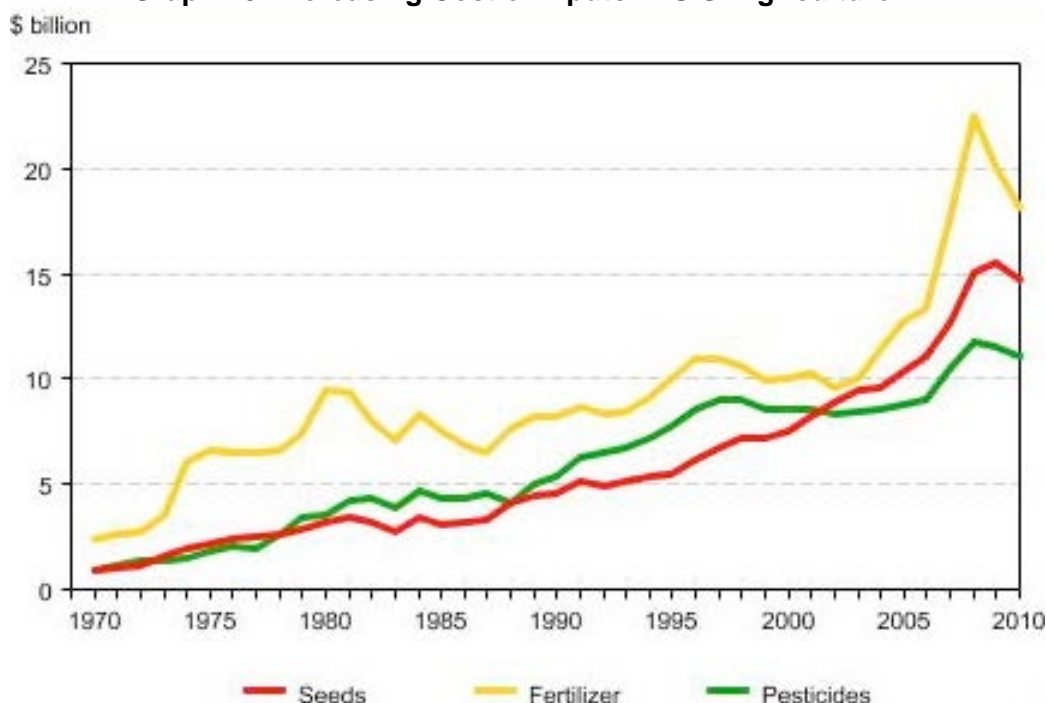

Source: Economic Research Services, United States Department of Agriculture.

In 2008, the manufactured inputs in Colorado totaled \$796,967,000. Fertilizers, pesticides, and energy are some of the main inputs in Colorado Agriculture. Figure 23 shows the costs of four main agricultural inputs in Colorado, petroleum fuel and oils being the largest cost.

Figure 24: Dollar Amount of Manufactured Inputs in Colorado⁴⁶⁰

Item	Dollars
Petroleum Fuel and Oils	303,235,000
Fertilizers	243,557,000
Electricity	137,121,000
Pesticides	113,054,000

Adapted from the USDA and the Colorado Department of Agriculture

Measuring the total costs of inputs is difficult because much of the costs are indirect, which creates negative externalities (non-market costs) usually paid by society as a whole.⁴⁶¹ Some of these costs include groundwater contamination, soil erosion and degradation, and pesticide residues in food. **Conventional agriculture** has benefited the U.S. because of the low-cost food it has provided. Food and feed produced by conventional agriculture is more expensive than perceived due to the external costs that are not factored into food prices, because farmers do not pay for them.⁴⁶²

6.2 Fertilizers

Fertilizers provide nutrients to improve plant growth and crop yield. Nitrogen is vital to a plant's ability to develop proteins and enzymes, which then helps the plant grow.⁴⁶³ Fertilizer use depends on several factors including soil type, soil fertility, climate, crop rotations, and price. Although some farmers use organic fertilizers (plant, animal, or mineral based) and animal manure, synthetic commercial fertilizers are the main type used in U.S. agriculture.^{464, 465} After petroleum fuel and oils, the highest expenditure on manufactured inputs in Colorado is fertilizers (Figure 24).⁴⁶⁶ Commercial fertilizers can be economical, but like all types of fertilizers, when the plant requirements do not balance with the amount of fertilization, excess nutrients can contribute to water contamination.⁴⁶⁷ More information on the effects of fertilizers on water contamination can be viewed in section 4. *Water Pollution*.

Of the total commercial fertilizer use in the U.S., nitrogen-based fertilizers comprise the largest portion, with a 56 percent share compared with 24 percent for **potash**, and 21 percent for phosphate (Graph 11).⁴⁶⁸

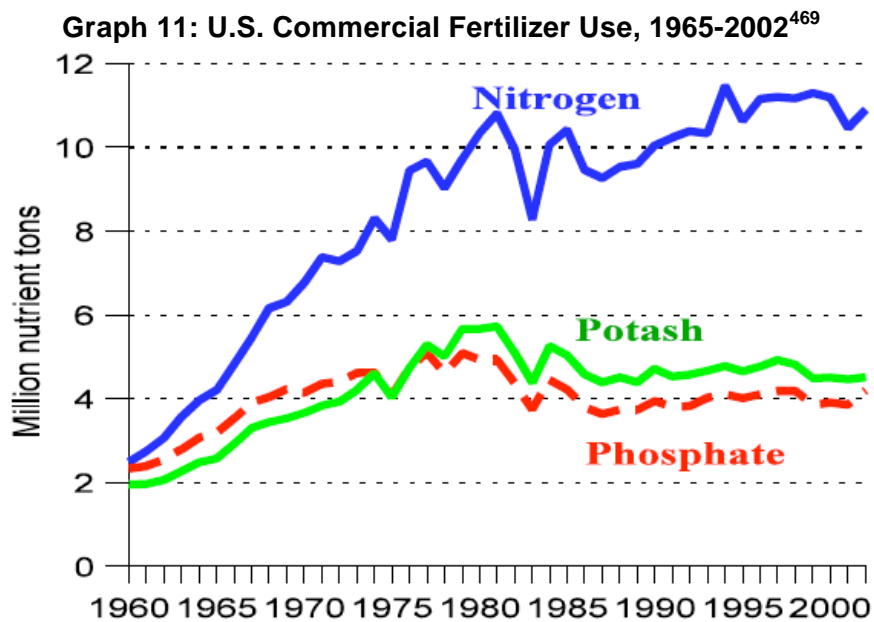

The cost of commercial fertilizer is greatly increasing. Since nitrogen costs can be the largest fertilizer expense for farmers, the overall cost of inputs is rising for conventional farmers. The United States Department of Agriculture (USDA) states, “because natural gas is the main input used to produce ammonia, which, in turn, is the main input used to produce all nitrogen fertilizers, the volatile and upward-trending price of natural gas in recent years has affected the price and supply of ammonia, and, thereby, the supply and price of nitrogen fertilizers, which is a great concern to U.S. agriculture.”⁴⁷⁰

An increase in price of natural gas has caused a reduction in domestic production of ammonia, which has caused ammonia plants to shut down in the U.S.⁴⁷¹ This has increased U.S. dependence on imported ammonia, which has risen since 2000. The USDA reports, “from 2000 to 2006, annual U.S. imports of ammonia increased from 3.9 to 8.4 million tons, an increase of 115 percent, while ammonia exports remained constant.”⁴⁷² See Graph 12 and Graph 13.

Graph 12: U.S. Ammonia Imports, Exports, and Net Imports⁴⁷³

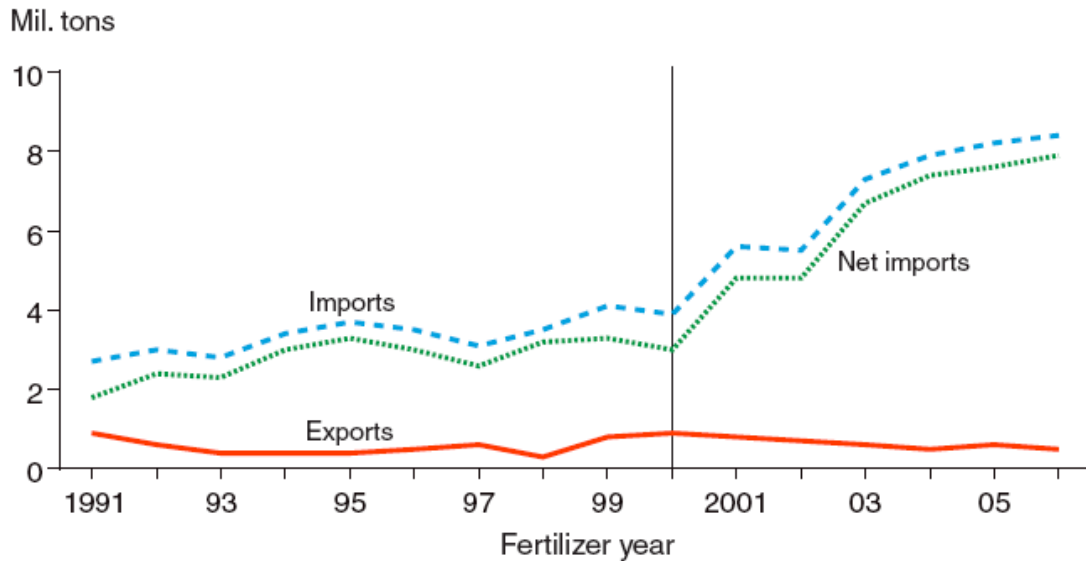

Note: Fertilizer year runs from July of the preceding year to June of the year indicated in the chart

Source: USDA, Economic Research Service

Graph 13: U.S. Nitrogen Supply from Domestic Production and Net Imports⁴⁷⁴

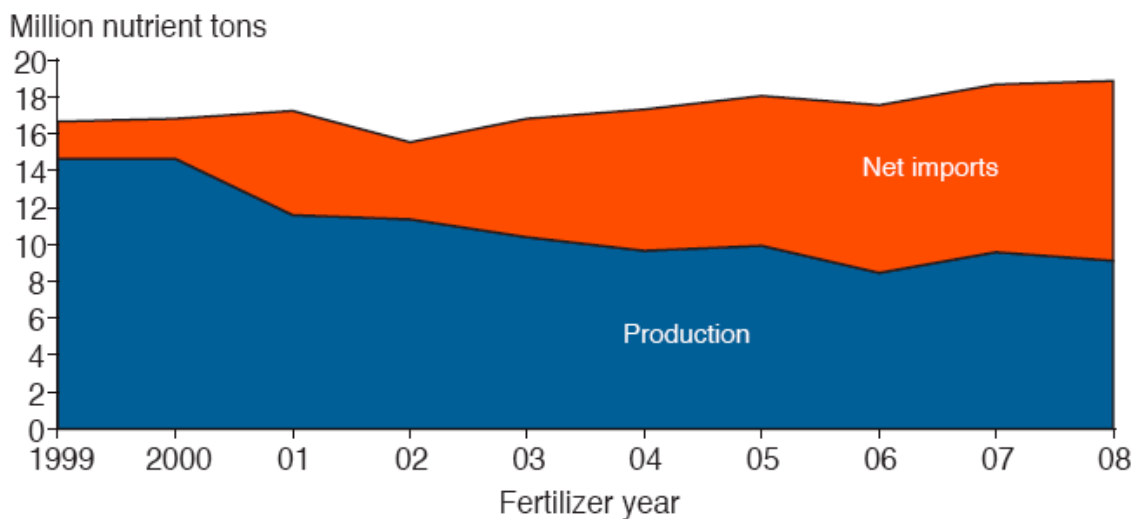

The production of commercial fertilizers requires not only natural gas, but also electricity and petroleum, which are used in the manufacturing process. Fertilizer is transported through pipeline, barges, railways, and trucking systems, which rely heavily on petroleum. Figure 25 displays the location of U.S. ammonia production plants and their capabilities. The rise of both electricity and petroleum will lead to increased cost in fertilizers.⁴⁷⁵ The future of the price of commercial fertilizers is unknown, because of its dependence on non-renewable resources. If domestic natural gas prices are low relative to other countries, it will be more cost effective to produce ammonia in the U.S., but if natural gas prices rise domestically, ammonia imports will increase.⁴⁷⁶

Figure 25: U.S. Ammonia Production Plants, 2005-06⁴⁷⁷

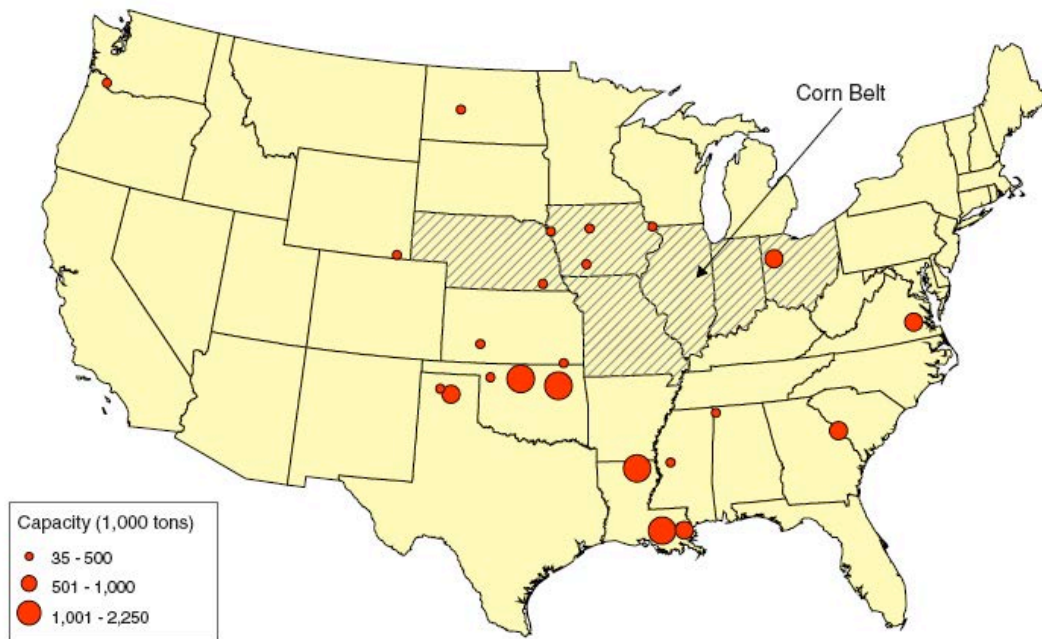

In addition to commercial fertilizer being costly to farmers, it also consumes the most energy. For more information on farm energy use, see section 2.1 *Breakdown of Energy Use*. The National Sustainable Agriculture Information Service states, “about a third of all energy used in U.S. agriculture goes to commercial fertilizer and pesticide production, the most energy-intensive of all farm inputs.”⁴⁷⁸ Because commercial fertilizer prices are increasing, manure is becoming a more valuable source of nitrogen fertilizer. Crop producers are either buying manure from livestock producers or adding livestock to their crop operations so that they can incorporate manure into their practices.⁴⁷⁹ That said, agriculture production still relies heavily on commercial fertilizers.

In 2007, 10,533 farms in Colorado used chemical fertilizers and soil conditioners and only 3,723 farms used manure for fertilization. Obviously there are farms that use both types of fertilizers.⁴⁸⁰ In Boulder County, 293 farms used chemical fertilizers, and soil conditioners, on a total of 25,785 acres. There were 147 farms that used manure as a fertilizer in Boulder County, totaling 4,477 acres.⁴⁸¹

Non-manufactured nitrogen fertilizers can be used to minimize use of commercial fertilizers and reduce vulnerability to the price changes in fossil fuels. These alternatives include livestock manure and green manure. Integrating livestock into crop production can have environmental and economic benefits. Great economic gains have been found when integrating these production systems. The livestock can eat the crop residue reducing the need for hay and their manure can be used as a nitrogen fertilizer. Manure in integrated systems is less expensive, because it is not distributed from livestock facilities, which requires energy for transportation.⁴⁸²

6.3 Pesticides

The majority of U.S. farmers rely on synthetic pesticides for their pest management.⁴⁸³ Three categories of pesticides - herbicides, insecticides, and fungicides - comprise the majority of chemical expenditure in the U.S.,⁴⁸⁴ and have led to the increase in yields that has been witnessed in the U.S.⁴⁸⁵ As discussed in section 6.1 *Agricultural Use of Inputs*, pesticides are relatively inexpensive because the indirect costs are not factored into the price. Depending on how cost is evaluated, pesticide use can be considered greatly beneficial to the consumer because of the cost savings on food.⁴⁸⁶ For additional information on pesticides, see section 7. *Pest Management*.

6.4 Seeds

The seed industry in the U.S. has changed over the past century; farmers typically buy seeds instead of saving them from year to year. This switch to a seed industry has evolved from plant breeding and **transgenic crops**. The research and development of seeds now plays a large role in U.S. agriculture. The patentability of seeds started with hybrid varieties of corn and eventually led to GE seeds.⁴⁸⁷

The seed industry in the U.S. has both grown and consolidated over time, and has raised some concerns about the market power it has in the agriculture industry. One beneficial aspect of consolidation is that it has caused seed companies to be more efficient or reduce seeds costs. Additionally there has been an increase in the percentage of research and development performed by private companies, and a decrease in public funding.⁴⁸⁸ Seed expenditure has risen as a percent of total farm expenditures since the 1960s (Graph 14: Seed Expenditures' Share of Total Farm Expenditures).⁴⁸⁹

Graph 14: Seed Expenditures' Share of Total Farm Expenditures⁴⁹⁰

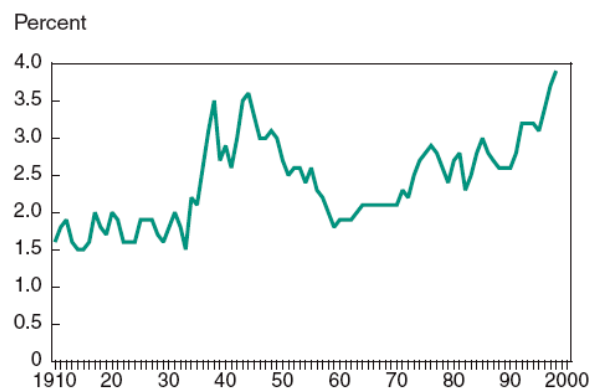

Hybridization of Seeds

One of the most significant seed innovations was the development of hybrid crops in the 1930s, particularly corn. Hybridization allows breeders to enhance certain biological characteristics more predictably and more quickly than natural selection (sometimes termed “selection”). Corn, as an **open-pollinated** (OP) crop, was well suited to the inbreeding-hybridization process. Hybrid corn seeds have their benefits for farmers, which include: higher yield potential, greater uniformity immaturity, and resistance to lodging making mechanization possible. The advantage of hybridization for seed firms is that the enhanced vigor of the hybrid seeds is not transmitted to its offspring, requiring farmers to buy new seed every year. The first seed company was organized for the commercial production of hybrid corn in 1926, but hybrid corn production only began to expand in the early 1930s. By 1960, the share of corn acreage cultivated with hybrid seed in the U.S. had reached 95 percent and almost all OP corn cultivated in the U.S. was replaced by hybrids by the 1960s.⁴⁹¹

Genetically Engineered Seeds

In conventional plant breeding, available genes and traits are limited due to sexual incompatibility to other lines of the crop and their wild relatives. This restriction has led to the development of **genetic engineering**, which in principle allows introducing valuable traits of any organism (other plants, bacteria, fungi, animals, viruses) into the genome of any plant.⁴⁹² Genetically engineered (GE) crops are classified into one of the three categories: crops with enhanced input traits (herbicide tolerance, insect resistance, and resistance to environmental stresses), crops with added value output traits (nutrient-enhanced seeds), and crops that are used for products (pharmaceuticals, bio-based fuels, and other products).⁴⁹³

Hybrid and GE seeds are patentable and therefore cannot be legally saved, and replanted for the following year.⁴⁹⁴ Although farmers might prefer GE seeds, because their use may lead to higher yields and higher revenues, GE seeds are more expensive than traditional seed. Because of the high research and development of **agricultural biotechnology**, the extra costs of GE seed companies are passed on to the farmers. This is one reason why the benefits of adopting GE crop practices vary. Another example of how benefits can vary is if the level of insect infestation is high, the benefits from *Bacillus thuringiensis* (Bt) GE seeds will be greater than if insect infestation was low.⁴⁹⁵

Use of GE seeds can affect farming practices by changing the type of tillage practiced. For example, a possible benefit of herbicide tolerant (HT) crops is soil conservation, through adoption of conservation tillage practices. Herbicide tolerant crops may allow farmers to use post-emergent herbicides, such as glyphosate, and avoid pre-emergent herbicides that would be incorporated into the soil. This is a possible benefit that needs to be studied in practice to observe if soil health is actually improving as a result of GE crops.⁴⁹⁶ Herbicide tolerant soybeans have had a great impact on tillage practices. According to the USDA, about 60 percent of HT soybean acres planted in 1997 used conservation tillage, while only 40 percent of the conventional acres planted used conservation tillage. HT soybean crops have had an even bigger effect on no-till practices compared with conventional tillage, which are 40 percent and 20 percent of acres planted respectively.⁴⁹⁷

Cross-Pollination

There is concern among farmers, consumers, and the organic food industry about fields planted with GE seeds and their proximity to those planted with non-GE seeds. This concern has stemmed from potential cross-pollination of GE and non-GE crops. Pollen drift with GE crops has received greater attention than with non-GE crops, because contamination by GE crops can cause an economic loss to farms using non-GE crops, especially certified organic farms. There is no debate that cross-pollination can and does happen in all types of agriculture. In Boulder County, some organic and conventional farmers are concerned about the possible economic loss if GE pollen contaminates their non-GE crops.⁴⁹⁸ Organic crops cannot contain genetically modified organisms and therefore would greatly lose value if cross-contamination were found in their crops.⁴⁹⁹

The concern of pollen drift in Boulder County prompted a study to estimate and evaluate the amount and distance of pollen drift in GE and non-GE corn. The two test sites included one containing blue kernel color on BCPOS land and the second on an adjacent cooperating farmer's land with the common GE corn containing the Roundup Ready® trait. The study concluded that a 46-meter or about 151 feet would allow a barrier that would ensure a less than one percent chance of cross-pollination.⁵⁰⁰ Past field experiments on cross-pollination of corn concluded that 200m (660 feet), was sufficient to limit cross-pollination to one percent or less. A distance of 300m could limit cross-pollination to 0.5 percent or less.⁵⁰¹ A review of past experiments concluded that levels of cross-pollination are affected by the size of the "emitting" crop and the strength of the wind.⁵⁰²

There is contention between studies on the appropriate barriers between GE crops and other crops. Since corn pollen is much larger than pollen produced by most grasses and is among the largest particles found in the air, it drifts to the ground quickly and does not normally travel the distance of pollen produced by other members of the grass family. Corn pollen may remain viable from a few hours to several days following its release and can survive up to nine days when stored in refrigerated conditions. Under normal field conditions, pollen is normally viable for only one to two hours. A probable reason for the discrepancies among studies is that temperatures and humidity affect the viability of pollen and the different conclusions among studies could be attributed to the varying levels of temperature and humidity in the areas studied. Pollen has a reduced period of viability for pollination in areas with high temperatures and low relative humidity.⁵⁰³

6.5 Current Regulations

Regulations concerning agriculture are numerous and thus a substantial review could not be included in this literature review. Two of the most current regulations applicable to Boulder County and the GE regulation process are described below.

GE Regulation Process

In the U.S., the regulatory process for GE foods is under the jurisdiction of three separate agencies: the Environmental Protection Agency (EPA), the Food and Drug Administration (FDA), and the United States Department of Agriculture. Each agency performs a different function, essentially, the EPA regulates the environmental safety, the USDA evaluates the safety of the plant, and the FDA evaluates whether the plant is safe in food. The USDA has many internal divisions that assess GE foods including: the Animal Plant Health Inspection Service (APHIS), which is responsible for issuing permits of approval for GE organisms, the Agricultural Research Service, and the Cooperative State Research, Education, and Extension Service.⁵⁰⁴

Before issuing a permit the APHIS evaluates whether the GE crop will:⁵⁰⁵

- Expose other plants to pathogens
- Harm other organisms, including agriculturally beneficial organisms, threatened and endangered species, and, in the case of plants that produce pesticides, organisms that are not the intended target of the pesticide (non-target organisms)
- Increase weediness in another species with which it might cross
- Have an adverse effect on the handling, processing, or storage of commodities
- Threaten biodiversity

A number of factors determine which laws and regulations apply to GE foods and products. These include: the stage of development, the intended uses, the type of possible hazards, and the type of organism.⁵⁰⁶ Intended uses determine which regulation applies to a given product derived from a genetically engineered organism. Given the large number of regulating agencies, regulations, and statutes that apply to GE products, there are some discrepancies concerning who regulates which product. Figure 26 illustrates the broad categories of regulation and which agency evaluates the product. For example, whole food plants are regulated by the Food, Drug, and Cosmetic Act, under the FDA.⁵⁰⁷

Figure 26: Agencies Responsible for Regulating Genetically Engineered Organisms⁵⁰⁸

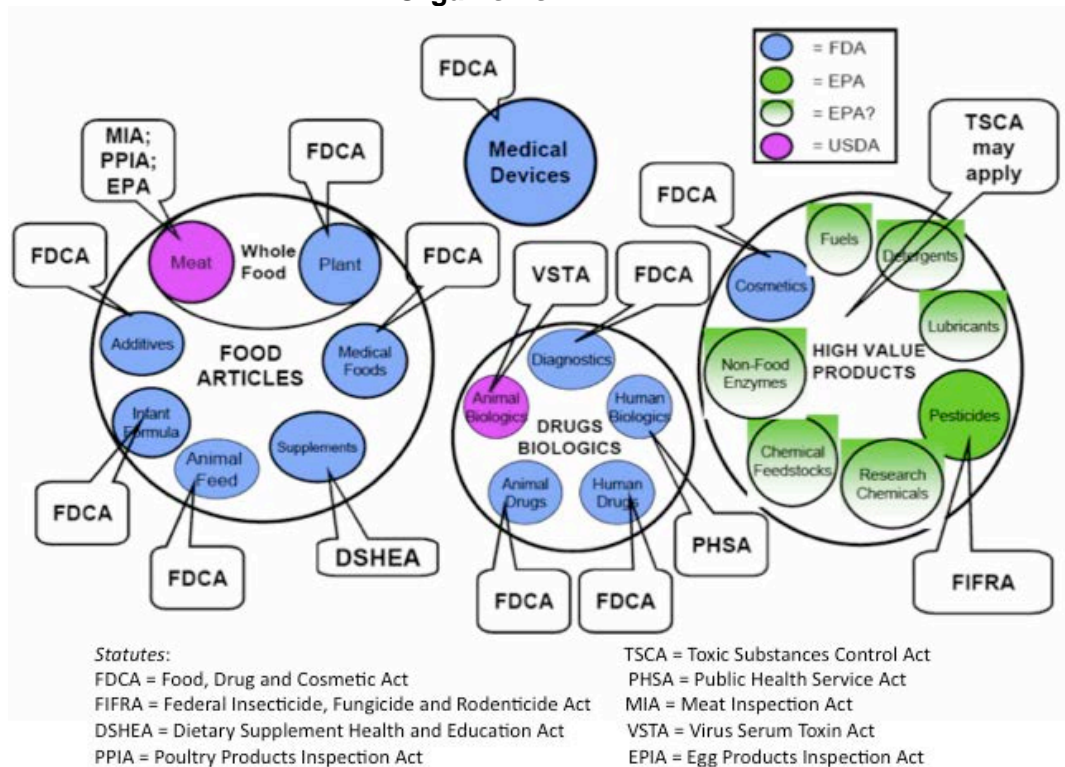

Note: The green and white categories (“EPA?”) are those that conceivably could be regulated by EPA under TSCA if they both were not regulated under another statute and posed an unreasonable risk of harm to people or the environment.

USDA Deregulation of GE Alfalfa

Alfalfa is the fourth largest crop by area harvested in the U.S. (over 20 million acres). Only about 40 percent of alfalfa fields are strictly alfalfa, the other 60 percent contain a mixture of alfalfa and grasses.⁵⁰⁹ On January 27, 2011 the USDA announced that GE Roundup Ready® (RR) alfalfa, which is resistant to the effects of the weed killer glyphosate, would be non-regulated, meaning that the planting of GE RR alfalfa can be done without any restrictions. The decision could set a precedent for the deregulation of other GE crops in the future. The listed benefits of GE alfalfa are that it is reported to not have any nutritional or biological difference to non-GE alfalfa, could increase yields, and decrease price.⁵¹⁰ However, the gene transfer that can take place between the RR GE alfalfa and non-GE crops is still a concern.

The potential for gene transfer in alfalfa grown for hay is not the same as that of alfalfa grown for seed due to very different production methods. Cross-pollination between RR alfalfa seed crops and that of a non-GE alfalfa seed crops has been realized in studies in Idaho and California. In contrast, gene transfer from one alfalfa hay field to another is theoretically possible, but several environmental barriers must occur for this to happen. These include: flowering must be simultaneous between fields, pollinators must be present, the pollen must accomplish fertilization, and those seeds must fall to the ground and germinate. When the vast majority of alfalfa hay fields are harvested, none of the seeds produced are viable for seed production and only zero to 25 percent of the alfalfa

has flowered. However, there are conditions that increase the chance of gene transfer, such as excess heat and late harvests where seed is allowed to mature.⁵¹¹

Opponents, many of them organic farmers, believe that GE alfalfa will cross-pollinate and contaminate organic and other non-GE crops, which would destroy the value of these crops. For more information on cross-pollination, see section 6.4 *Seeds*. Consumer opponents are concerned with GE alfalfa being transferred up the food chain into foods for human consumption such as beef and dairy products. The Secretary of Agriculture, Tom Vilsack, stated that the USDA would take steps to ensure that GE alfalfa would not cross-pollinate. Jeff Wolt, an agronomist at the Iowa State University Seed Science Center, does not believe that this is possible, stating, “some degree of cross-pollination will occur regardless of what mechanism is going to be put in place.”⁵¹²

The USDA states that it will commit one million dollars to the Biotechnology Risk Assessment Grants program to restrict pollen flow and to promote co-existence of alfalfa production.⁵¹³ This initiative will be implemented after deregulation.⁵¹⁴ As it stands now, creating a barrier to minimize risk of contamination is the responsibility of the non-GE farmers, because there is no regulation stating that GE alfalfa has to be planted at a certain distance from non-GE crops.

GE crop contamination has been a problem in the past, with over 200 episodes reported, costing farmers hundreds of millions of dollars in lost revenue.⁵¹⁵ The Center for Food Safety has already filed a lawsuit against the USDA because the organization believes that the Final Environmental Impact Statement was rushed, and believes that several factors were not properly assessed.⁵¹⁶

Regulation of GE Sugar Beet Planting

On February 4, 2011, the U.S. Department of Agriculture’s Animal and Plant Health Inspection Service released the following statement, “APHIS has determined that the Roundup Ready (RR) sugar beet root crop, when grown under APHIS imposed conditions, can be partially deregulated without posing a plant pest risk or having a significant effect on the environment.”⁵¹⁷ The Monsanto Company (Monsanto) and the seed company KWS issued the request for partial deregulation of RR sugar beets.⁵¹⁸

Some of these mandatory conditions for the partial deregulation of RR sugar beet root crop production activities and seed production activities include:⁵¹⁹

- Planting of H7-1 sugar beets is not allowed in the state of California, and the following counties in Washington State: Clallam, Clark, Cowlitz, Grays Harbor, Island, Jefferson, King, Kitsap, Lewis, Mason, Pacific, Pierce, San Juan, Skagit, Skamania, Snohomish, Thurston, Wahkiakum, and Whatcom.
- Root growers shall ensure that root crop fields are surveyed to identify and eliminate any bolters before they produce pollen. Root growers shall maintain all records of inspection and bolter removal and records must be made available to APHIS/BRS and/or to authorized third party inspectors upon request.
- Third party inspectors procured by beet processors (usually a cooperative) shall randomly choose a statistically representative sample of fields and conduct inspection for bolters. If bolters are identified, field personnel shall be notified immediately and those bolters must be removed.



- Planting/cultivating/harvesting equipment that might be used in chard/red beet production shall not be used or shared for regulated GE material in the same growing year.
- Root crop fields shall be monitored for three-year following harvest for volunteers and any volunteer plants must be destroyed. If the same land is used for crop cultivation during the volunteer monitoring period, that crop shall be visually distinct from sugar beets or the fields must be left fallow.
- All root crop growers and field personnel must receive all conditions and restrictions identified in the compliance agreements and must be trained in the all processes and procedures necessary to comply with the terms of the agreement.
- Root growers shall maintain records of all the activities being carried out under the compliance agreements to demonstrate adherence to the mandatory conditions and restrictions.
- Seed producers (permit holders) of H7-1 sugar beets are required to maintain a four-mile separation distance between male fertile **H7-1 sugar beets** and all other commercial Beta seed crops (i.e., table beets, Swiss chard) as part of the mandatory condition regarding isolation distances across the U.S.
- A visual identification system, such as labeling, that accompanies the regulated material throughout the production system, is required.
- Planting, cultivation, and harvesting equipment shall be cleaned to prevent H7-1 **stecklings** or seed from being physically transferred out of production areas or mixed with non-GE *Beta* material by inadvertent means.
- All unused H7-1 stecklings shall be treated as regulated articles until devitalized and discarded.
- All H7-1 seed and steckling material shall be moved in contained transport systems to avoid inadvertent release into the environment. Vehicles or movement containers shall be thoroughly cleaned after transport and any regulated material recovered shall be devitalized.
- Sexually compatible varieties (e.g. chard/red beet) cannot be planted or produced in the same location (the same field) as H7-1 in the same growing year.
- Measures to force same year sprouting of H7-1 seed left in production fields are required. Any seed that sprouts from such leftover seed shall be destroyed.
- No H7-1 seed shall be cleaned or processed in any processing facility that also cleans and processes red beet or Swiss chard seed.

For the complete lists of mandatory conditions for crop root production activities, importation and interstate movements associated with root production, and seed production activities, see *Mandatory Condition Requirements for Roundup Ready Sugar Beets.*⁵²⁰



The decision was based on an environmental assessment conducted by APHIS, which was published for public comment in November 2010. The partial deregulation of RR sugar beets is an interim measure and the final ruling concerning full deregulation will be made by the end of May 2012 after a full Environmental Impact Statement is completed.⁵²¹ Their intent to allow planting of GE sugar beets in the meantime was made clear.⁵²²

Although the statement by the USDA on February 4th allows partial deregulation of the planting of genetically modified sugar beets, a separate hearing was held on February 15, 2011.^{523, 524} During this hearing, the defendants, Monsanto Company, American Crystal Sugar Company, Syngenta Seeds Inc., and Betaseed Inc., sought to reverse a previous mandate requiring the removal of RR sugar beet seedlings that had already been planted.⁵²⁵ Those in opposition included the Center for Food Safety, Organic Seed Alliance, Sierra Club, and High Mowing Organic Seeds.⁵²⁶ This mandate was reversed. This decision was determined due to the fact that the plaintiffs failed to demonstrate any likeliness of irreparable harm.⁵²⁷

7. Pest Management

Summary

In the U.S., the amount (pounds) of applied pesticides has decreased from a highpoint in the early 1980s and has remained relatively stable over the past few decades. Pesticides are partially responsible for increasing the productivity of agriculture during the last century and continue to be a critical factor in reducing crop damage. The overall reduction in pesticide applications is attributed to several factors including quality improvements in the mix of pesticide ingredients, increases in ability to target specific pests, improved pesticide application methods and management from farmers, and high rates of adoption of genetically engineered (GE) crops.

Despite reductions in overall pesticide usage, direct and indirect financial expenditures remain high, with Colorado farmers spending roughly \$113 million on pesticides in 2008, or about five percent of operating expenses. Estimates of the external expenses, from impacts including pesticide poisonings to humans, reduction of fish and wildlife populations, livestock losses, honey bee losses, reduction of beneficial insects, and increased pesticide resistance in weeds and insects have been placed at \$8 billion annually for the U.S. One of the most recent and profound changes to pest management has been the high rate of adoption for GE crops since their introduction in 1996. The most popular GE crops are those that contain pest management traits, either herbicide tolerance or insect resistance. Roundup Ready®, and Liberty Link® maize are two varieties of GE crops grown in Boulder County currently. Overall, the literature has shown that GE crops can have environmental benefits due to generally decreased pesticide usage and stimulation of soil conservation practices.

Estimates of the rates of pesticide use on transgenic varieties vary between crops and production systems, but have generally been found to reduce overall applications in the range of 3-15 percent, with some studies finding higher averages of 25-33 percent compared to conventional crop varieties and systems. While the adoption of GE crops has been shown to reduce the pounds of active ingredients of herbicides and insecticides, it has also been found to increase the use of the specific type of herbicide that the transgenic variety has been engineered to resist. A prominent example is a variety of herbicide resistant (in this case glyphosate) soybeans, which have reduced the need for overall quantity of non-glyphosate herbicides, but more than doubled the kilograms used per hectare of glyphosate.

The increased reliance on pesticides in both conventional and GE cropping systems has increased the development of pesticide resistant species, and now over 300 different biotypes have displayed resistance to one or more herbicides or insecticides. At present the North American Herbicide Resistance Action Committee and the Weed Science Society of America (WSSA) have identified four different types of herbicide resistant weeds in Colorado, at over 2,000 sites and infesting about 66,000 acres in the state. The potential prevalence of pesticide resistance in weeds and insects was estimated in several studies to have the capacity to decrease benefits of current chemical pesticides, requiring more or different pesticides to achieve similar results in the future, and potentially negating previous environmental and financial benefits. Integrated pest management (IPM) is widely recognized as a method for reducing the use of chemical pesticides, while still limiting damage from pests, though several authors note the slow rates of adoption and local nature of methods as limiting factors to IPM being used more frequently.



7.1 Pesticide Usage

Pesticides are commonly broken out into three major types: herbicides, insecticides, and fungicides (Graph 15).⁵²⁸ They are used to control approximately 600 species of insects, 1,800 weed species, and numerous species of fungi and nematodes all, of which are considered serious pests in agriculture.⁵²⁹ There are three basic ways to evaluate pesticide usage. The first is the number of different pesticides applied on a given acre, the second is the total pounds of pesticide active ingredients applied per acre in a given year, and the third is the toxicity profile of pesticides used (section 10.1 Food Safety).

Graph 15: Overall Pesticide Usage 1964 to 2001⁵³⁰

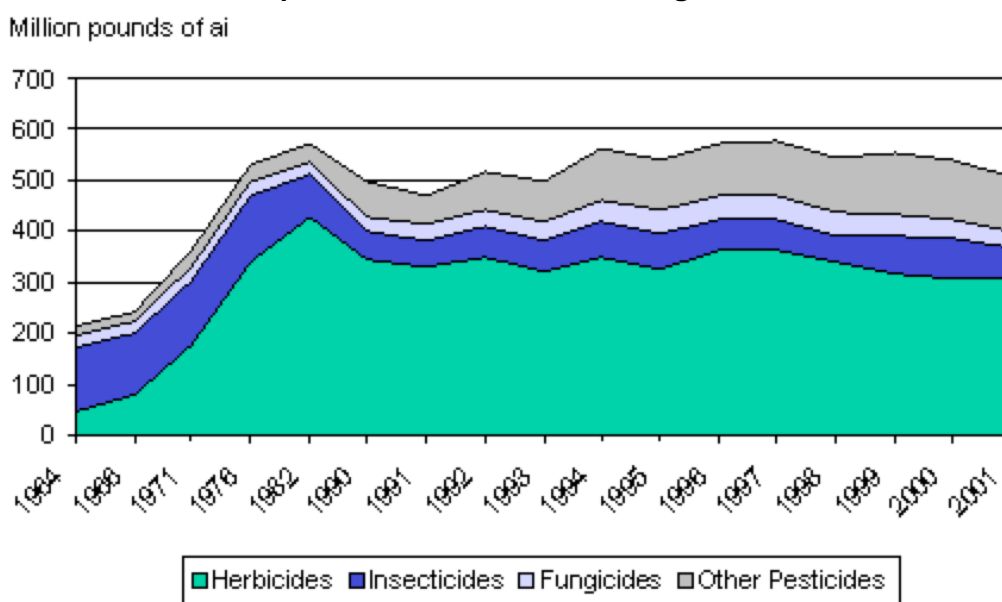

The total pounds of active pesticide ingredients applied to crops rose steadily from early 1960 until the 1980s, from which time it has remained relatively unchanged.⁵³¹ The initial increase in pesticide usage can largely be attributed to both the adoption of monocropping practices, which can make crops more vulnerable to pests, and to excessive or imprecise application of pesticides. Due to quality improvements in the mix of pesticide active ingredients, increases in the ability to target specific pests, and improved pesticide application methods and management by farmers, usage and growth rates leveled out.⁵³² Additionally, between 1982 and 1990, commodity prices fell and as a result large amounts of land were taken out of production.⁵³³ Despite these reductions in quantity, the per-unit price of synthetic pesticides has continued to increase.⁵³⁴

According to the USDA, since about 1990, pesticide usage has edged above the 1982 peak, largely due to expanded use of soil fumigants, defoliants, and fungicides on potatoes, fruits, and vegetables. Total herbicides and insecticides have remained relatively unchanged despite more intensive insecticide treatments on cotton and potatoes, and an increased share of wheat acres treated with herbicides.⁵³⁵

The amount of insecticides currently applied to U.S. crops is significantly down from the peak in the 1970s, and now fluctuates between 60 and 80 million pounds annually. Insecticides account for 12 percent of total pesticides applied to U.S. crops.⁵³⁶ Graph 16 shows the most commonly applied insecticides.

Graph 16: Most Common Insecticides in the U.S.⁵³⁷

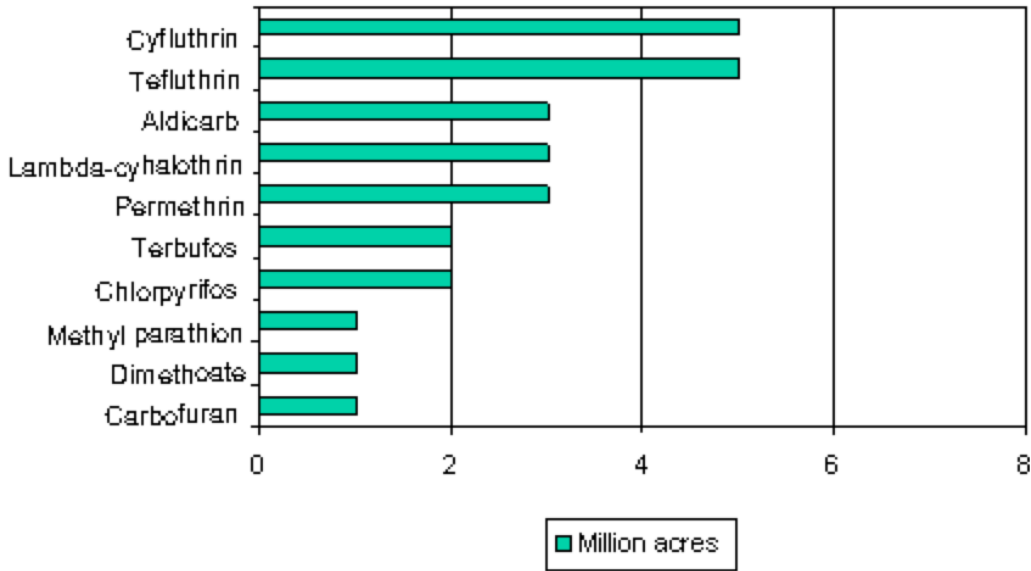

Herbicides represent the largest pesticide class, accounting for about 60 percent of total pounds of pesticide active ingredient applied to U.S. crops. The most common pesticides are presented in Graph 17. For a discussion of potential water pollution concerns, see section 4.4 *Pesticides as Water Pollutants*.

Graph 17: Most Common Herbicides in the U.S.⁵³⁸

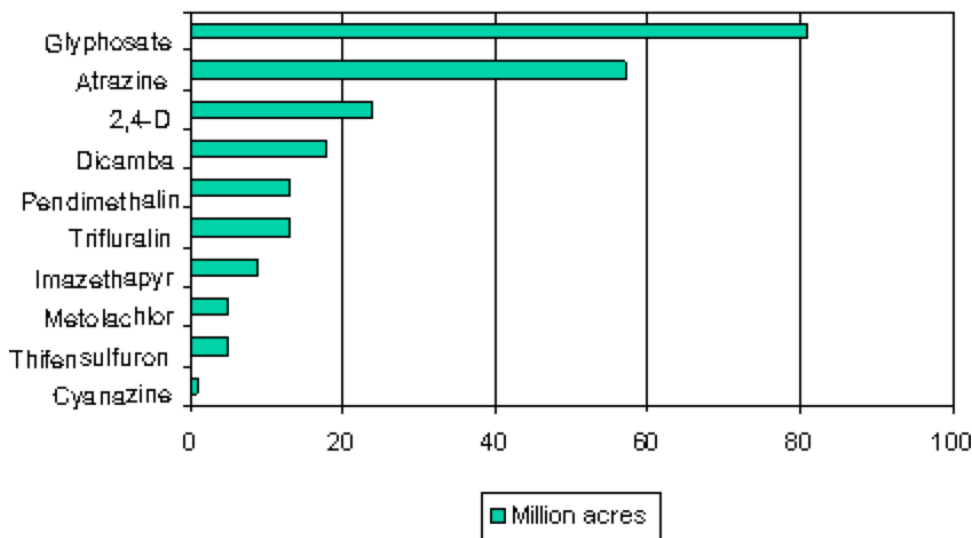

Cost

Costs regarding pesticide use can be looked at in one of two ways: the cost of using them and the cost of not using them. Costs of pesticide use can further be broken down into direct costs to farmers (in terms of production expenses) and external costs to the environment and human health. It is the concern of these external costs that has prompted a desire for decreased pesticide use, but this reduction results in costs in the form of reduced output and a subsequent decrease in employment in production, processing, and handling systems. A reduction in output also suggests increased prices of crops necessary for livestock production, thus having an even more widespread impact on our food industry.^{539, 540}

Pesticide's share of farm production expenses has grown significantly from less than one percent in 1960 to nearly five percent in 1998, which now represents the largest chemical expenditure in agricultural operations.⁵⁴¹ In 2008, expenditures on pesticides by Colorado farmers totaled well over \$113 million dollars.⁵⁴²

Pesticides are partially responsible for increasing the productivity of agriculture during the last century and continue to be a critical factor in reducing crop damage. Agricultural pests, including animals, insects, plants, fungi, and bacteria, can lead to loss of crops or reductions in crop yields, as well as reduce crop quality like blemishes on produce that can reduce the value of agricultural commodities. Even as farmers explore alternatives to chemical pesticide applications, such as biological control and genetically engineered (GE) crops, pesticide production and use remains an important tool for farmers.⁵⁴³

Much of the pesticide economics literature has focused on balancing the benefits of pesticide application (less crop damage) with the total costs, including those borne by the farmer (price of pesticide and cost of labor and machinery for application) and those imposed on society (such as risks to human health and diminished environmental quality from pollution). These studies have faced modeling difficulties due to the need to consider wide-ranging direct and indirect effects of pesticide applications.^{544, 545}

One of the first studies conducted by Knutson et al. in 1990 described the possible effects on U.S. agriculture and society of a hypothetical ban of herbicides, insecticides, and fungicides.⁵⁴⁶ Through their calculations, the authors hypothesized that year-end supplies of corn, wheat, and soybeans would drop 73 percent without the use of pesticides, requiring farmers to increase acreage to make up for reduced per-acre yields. A more recent study conducted in 2004 found that in general, each dollar invested in pesticide control returns about \$4 in protected crops. When the study extrapolated out this ratio to include all U.S. agriculture (as of 2004) the authors estimated pesticide control annually saves approximately \$40 billion in U.S. crops, based on direct costs and benefits.⁵⁴⁷ However, the indirect costs of pesticide use to the environment and public health need to be balanced against these benefits.

The cost associated with pesticides extends well beyond the farm. A Cornell study published in 2005, estimated that the external costs of pesticides in the U.S. totaled almost \$10 billion annually. The Figure 27 below shows the breakdown of these estimated costs.⁵⁴⁸

Figure 27: External Costs of Pesticides⁵⁴⁹

Costs	Millions of \$ per year
Public health impacts	1140
Domestic animals deaths and contaminations	30
Loss of natural enemies	520
Cost of pesticide resistance	1500
Honeybee and pollination losses	334
Crop losses	1391
Fishery losses	100
Bird losses	2160
Groundwater contamination	2000
Government regulations to prevent damage	470
Total	9645

Comparing the above costs with the impacts of not using pesticides has proven to be challenging and highly controversial. Analyses typically focus on the loss of output and the resulting economic impact and are highly variable depending on the crop, soil, and weather. Concrete data in the literature is therefore limited and quite often dated. Estimated yield losses due to disuse of insecticides and fungicides range from two to 26 percent (except for peanuts, fruits, and vegetables which tend to be much higher) and estimated yield losses due to disuse of herbicides vary from zero to 53 percent, all taken from sources dated between 1985 and 1993 (the years over which the data was aggregated, however, are unknown).⁵⁵⁰

Furthermore, methodologies involved in these analyses have been criticized for exaggerating pesticides' contribution to productivity through a variety of factors.^{551, 552, 553} These controversies are discussed in length by Cornejo, Jans, and Smith (1998)⁵⁵⁴ and Sexton, Lei, and Zilberman (2007).⁵⁵⁵ Despite the lack of agreement, however, Cornejo, Jans, and Smith (1998) validated the conclusion from a 1976 study that the per unit production "costs of reducing pesticide use for health and environmental considerations are relatively high." However, they noted that because the "value of marginal product of pesticides is declining" (i.e. the amount of additional pesticides needed to further increase yields) the per unit production costs from reducing pesticide use may also be declining.⁵⁵⁶

Complicating analyses further is the difficulty in determining the induced economic impacts of reduced output, such as impacts on the livestock industry and employment in the agricultural sector. This is particularly true when translating output at the state level into economic impacts on a national scale.⁵⁵⁷ While studies examining induced impacts could not be found, one older figure from the Food and Agriculture Organization (FAO) shows a 30 percent reduction in agricultural output with elimination of pesticide use. Considering impacts on the livestock industry, such a reduction in output is expected to yield a loss of three to four 1998 dollars per dollar spent on pesticides.⁵⁵⁸

7.2 Application Rates of Pesticides

The majority of U.S. farmers rely on chemical pesticides for their pest management.⁵⁵⁹ A Cornell entomologist estimated that only about one tenth (0.1) percent of all applied pesticides reach the intended target pests, leaving the bulk of pesticides in the environment as a potential hazard and representing a significant financial investment from the farmer.⁵⁶⁰

Of all agricultural pests, weeds are by far the most pervasive pests in U.S. agriculture in terms of the share of herbicide treatments used to control them. Most herbicides are used to treat weeds in corn and soybean production systems, while the main uses of insecticides and fungicides are for cotton and potato crops.⁵⁶¹

Studies have shown a general decrease in pesticide use since 1995, which can be seen in Graph 18. Although the use of herbicides for soybeans increased slightly between 1995 and 2002, corn herbicides and insecticides have decreased and cotton herbicides have decreased slightly (Graph 18).⁵⁶² The overall decrease in pesticide use is due, in part, to the increase of GE adoption since 1996.⁵⁶³

Graph 18: Pesticide Use in Major Field Crops⁵⁶⁴

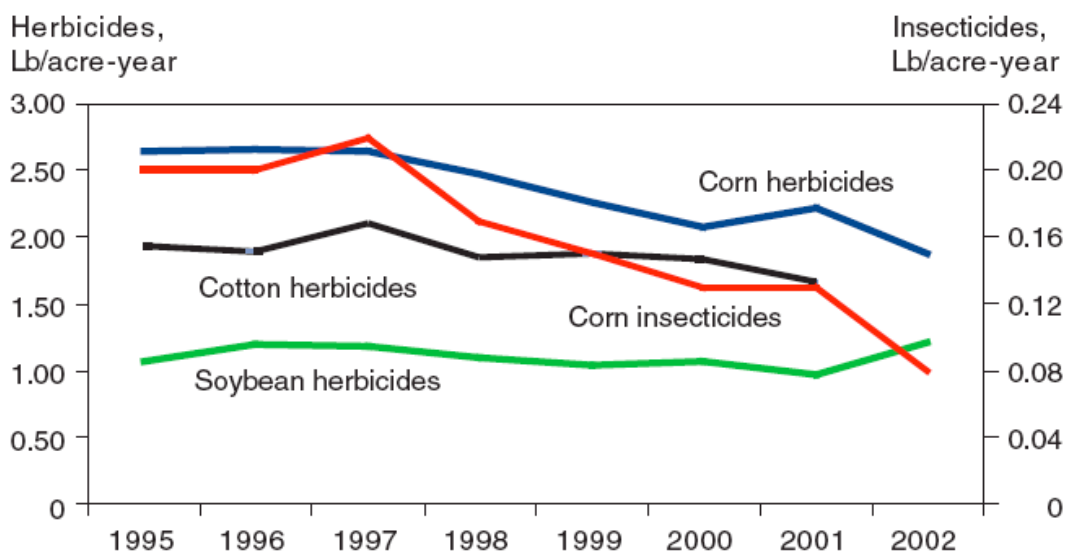

Adoption of GE Crops and Pesticide Use

U.S. farmers have widely adopted genetically engineered crops since their introduction in 1996, notwithstanding uncertainty about consumer acceptance and economic and environmental impacts. Soybeans and cotton with GE herbicide-tolerant traits have been the most widely and rapidly adopted in the U.S., followed by insect-resistant cotton and corn.⁵⁶⁵ Since 1996, the percentages of U.S. farmers who have adopted specific GE crops have increased dramatically (Graph 19).⁵⁶⁶



Graph 19: Rate of Adoption for Genetically Engineered Crops in the U.S.⁵⁶⁷

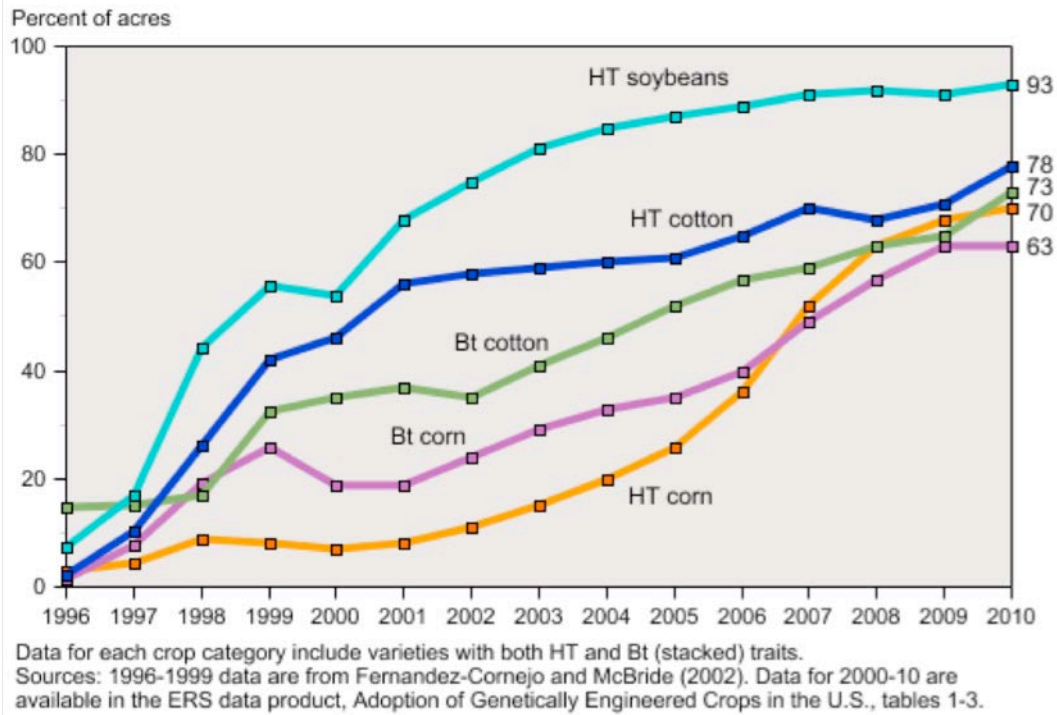

Biotechnology in agriculture is a highly debated topic because of transgenic crops, which were first developed in laboratories around 1983.⁵⁶⁸ The most common types of GE crops are those that contain pest management traits such as herbicide tolerance or insect resistance.⁵⁶⁹ Herbicide tolerant (HT) crops allow farmers to control weeds using herbicides that would usually destroy the crop. The most common herbicide-tolerant crops are Roundup Ready® crops that are resistant to glyphosate. Other herbicide resistant crops include Liberty Link® corn (resistant to glufosinate-ammonium) and BXN cotton (resistant to bromoxynil). In addition to genetically engineered HT crops, there are traditionally-bred herbicide-tolerant crops, such as corn that is resistant to imidazolinone and sethoxydim as well as soybeans that are resistant to sulfonylurea.⁵⁷⁰ Insect-resistant crops contain a gene from the soil bacterium *Bacillus thuringiensis* (Bt), which produces its own toxins to help protect the plant from insects. Farmers often see higher yields with **Bt crops** compared to conventional crops because the trait stays in the plant throughout the growing season, however, additional insecticides are still needed to manage pests that are not targeted by the Bt trait.⁵⁷¹ Roundup Ready® and Liberty Link® corn are two varieties of GE crops grown in Boulder County.⁵⁷²



More recently, crops are being developed with stacked traits, also referred to as stacked genes. Stacking traits allows a crop to contain a variety and combination of traits including herbicide tolerant and insect resistance traits.⁵⁷³ Other common traits incorporated and stacked in transgenic crops include disease resistance, high pH tolerance, and several nutritional, taste, texture, and shelf-life characteristics.⁵⁷⁴ Gene stacking is becoming more common, particularly in corn and cotton varieties. For example, nine percent of corn and 34 percent of cotton grown in the U.S. in 2005 were planted with stacked-gene varieties (Figure 28).⁵⁷⁵ Other studies reveal an increasing trend for stacked genes occupying a growing percentage of GE crops worldwide, though specific percentages for Colorado could not be obtained.⁵⁷⁶

Figure 28: Percentages of U.S. 2005 Crop Acreage Planted to Insecticidal, Herbicidal, and Stacked-Gene Varieties.

	Insect resistant	Herbicide resistant	Stacked-gene
Soy	0	87	0
Corn	26	17	9
Cotton	18	27	34

The Economic Research Service (ERS) of the United States Department of Agriculture (USDA) published a report in 2007 based on research collected and experiences gained with transgenic crops during the first decade of cultivation in the U.S. spanning the years 1996-2005.⁵⁷⁷ These authors concluded that transgenic crops could have environmental benefits due to generally decreased pesticide usage and stimulation of soil conservation practices.⁵⁷⁸

The reductions in quantities of herbicide active ingredients applied to GE herbicide-resistant crops have shown decreases averaging 25-33 percent of overall use, according to a study conducted by Sankulat et al.⁵⁷⁹ A separate study by Brookes and Barfoot,⁵⁸⁰ found a more modest decrease in pesticide usage averaging 6.3 percent. The authors used existing data on the farm-level impacts of transgenic crops to calculate the economic and environmental effects of all transgenic crops that had been cultivated over the nine-year period of 1996–2004. The crops evaluated included herbicide resistant soybeans, corn, cotton, and canola, as well as insect-resistant corn and cotton. The average reduction varies between 2.5 percent for herbicide-resistant corn and 14.7 percent for insect resistant cotton.

While GE crops reduce the overall use of pesticides, they often increase the use of a specific type of pesticide for which the transgenic variety has been engineered to resist.⁵⁸¹ As shown in Graph 20, a variety of herbicide resistant (in this case glyphosate) soybeans have reduced the overall quantity of non-glyphosate herbicides, but greatly increased the use of glyphosate.⁵⁸² This example is similar to other transgenic varieties, where overall pesticide use is reduced but applications of a single pesticide increased. This increased reliance and use of a specific pesticide has raised concern from many researchers about the increased development of resistant pests and in some cases the need for additional pesticides to combat the newly resistant pest varieties.⁵⁸³

As shown in Graph 20, transgenic crop varieties can reduce overall pesticide use and, to a lesser extent, provide greater yields and increased returns. The extent of these benefits depends greatly on the local conditions and farm operation as shown by the varying results presented.



Graph 20: Herbicide Use on Soybeans in the U.S.⁵⁸⁴

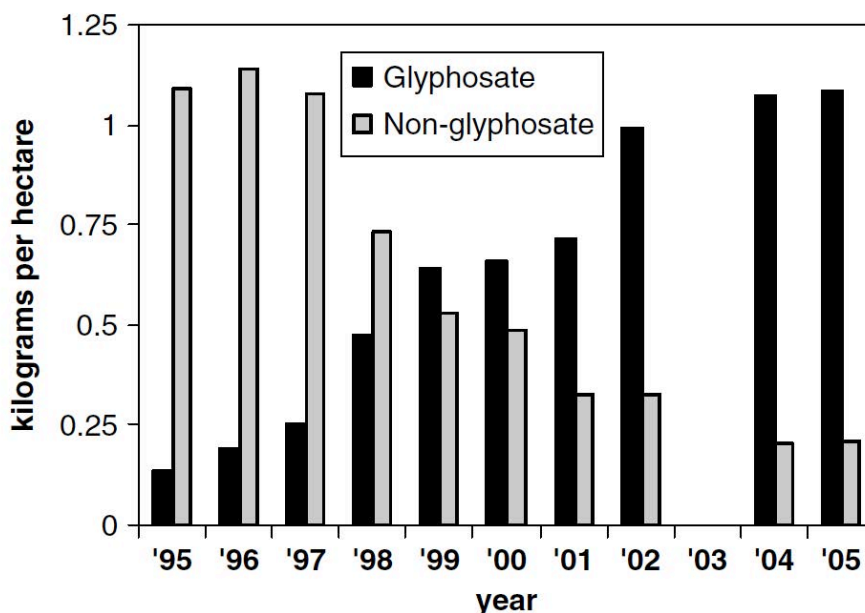

The review of the first decade of transgenic crops by the ERS USDA found that the currently available GE crops are not guaranteed to increase the yield potential. They found that the yield might decrease if the varieties used to carry the herbicide-tolerant or insect-resistant genes are not the highest yielding cultivars. However, they found that when pest infestation is high, GE varieties could help to prevent yield losses compared with non-GE hybrids.⁵⁸⁵

Herbicide Tolerance

Some GE Herbicide tolerant crops are engineered to tolerate high application rates of glyphosate, an herbicide that is used to control weeds. For example, glyphosate-tolerant soybean crops are able to tolerate twice the level of glyphosate application needed to control weeds without negatively impacting the yields. A study done on per acre net return of glyphosate-tolerant soybeans concluded that higher returns were a result of higher yields and lower herbicide costs. Glyphosate-tolerant soybeans were shown to have approximately a \$6 per acre higher return than traditional varieties. They found that the lower herbicide costs were enough to make up for the higher costs of seeds and technology fees.⁵⁸⁶

However, glyphosate-tolerant cotton does not show the same economic gains as glyphosate-tolerant soybeans. Field studies found that there is little difference in yields between using glyphosate-tolerant cotton and standard cotton. Although there were no economic gains by using glyphosate-tolerant cotton, less total herbicides were used in this study. Herbicide-tolerant corn showed no statistically significant difference in profit over conventional varieties, but did find that less total herbicides were used.⁵⁸⁷ While yields and market prices vary depending on the HT crop, fewer herbicides are used on all; however, they can also cause negative effects. Weed management and weed control have been simplified by HT crops, but can lead to a decreased understanding of weed biology and weed interactions, which could diminish the use of Integrated Pest Management (IPM) practices.⁵⁸⁸



Insecticide Tolerance

Similar to glyphosate-tolerant and other HT crops, the economic and environmental results of Bt crops vary depending on the crop type. Studies conducted in Georgia and Mississippi reported **Bt cotton** to have a large economic advantage over non-Bt varieties and fewer spray applications of insecticides.⁵⁸⁹ A three-year study in Arkansas found that yields and profits were higher for two of the years, but lower one of the years. **Bt corn** reported increased yields, but only a small reduction in insecticide application. Total profit was higher for Bt corn, including seed technology fees, because of the higher yields.⁵⁹⁰ These studies and others consider yield, pesticide use, and profit on a farm-level. The ERS summarized these studies to illustrate the variability among them, the results of which are shown in Figure 29.⁵⁹¹

Figure 29: Summary of the Effects of Genetically Engineered Crops on Yields, Pesticide Use, and Returns⁵⁹²

Crop/Researchers	Data Source	Yield	Effects on Pesticide Use	Returns
Herbicide-tolerant soybeans				
Delannay et al., 1995	Experiments	Same	na	na
Roberts et al., 1998	Experiments	Increase	Decrease	Increase
Arnold et al., 1998	Experiments	Increase	na	Increase
Marra et al., 1998	Survey	Increase	Decrease	Increase
Fernandez-Cornejo et al., 2002	Survey	Small Increase	Small increase	Same
McBride and El-Osta, 2002	Survey	na	na	Same
Duffy, 2001	Survey	Small decrease	na	Same
Herbicide-tolerant Cotton				
Vencill, 1996	Experiments	Same	na	na
Keeling et al., 1996	Experiments	Same	na	na
Golmand et al., 1998	Experiments	Same	na	na
Culpepper and York, 1998	Experiments	Same	Decrease	Same
Fernandez-Cornejo et al., 2000	Survey	Increase	Same	Increase
Herbicide-tolerant corn				
Fernandez-Cornejo and Klotz-Ingram, 1998	Survey	Increase	Decrease	Same
McBride and El-Osta, 2002	Survey	na	na	Increase
Bt cotton				
Stark, 1997	Survey	Increase	Decrease	Increase
Gibson et al., 1997	Survey	Increase	na	Increase
ReJesus et al., 1997	Experiments	Same	na	Increase
Bryant et al., 1998*	Experiments	Increase	na	Increase
Marra et al., 1998	Survey	Increase	Decrease	Increase
Fernandez-Cornejo et al., 2000	Survey	Increase	Decrease	Increase
Bt corn				
Rice and Pilcher, 1998	Survey	Increase	Decrease	Depends on Infestation
Marra et al., 1998	Survey	Increase	Decrease	Increase
Benbrook, 2001	Survey	Increase	na	Decrease
McBride and El-Osta, 2002	Survey	na	na	Decrease
Duffy, 2001	Survey	Increase	na	Same
Pilcher et al., 2002	Survey	Increase	Decrease	na
Baute, Sears, and Schaafsma, 2002	Experiments	Increase	na	Depends on Infestation
Dillehay et al., 2004	Experiments	Increase	na	na
Fernandez-Cornejo and Li, 2005	Survey	Increase	Decrease	na

* Results are for 1996 and 1998. Results were different in 1997 when pest pressure was low.

Insect resistance of the protein trait Bt decreases the efficiency of Bt crops and their projected benefits. Insecticidal crystal proteins, also considered toxins, from Bt are the basis of defense against targeted insects. Although there is now variation in the crystal proteins used in GE crops, some proteins, such as Cry1AB and Cry1Ac, are very similar and therefore insects that become resistant to one can be resistant to the other. The first generation of Bt crops only contained a single type of toxin throughout the growing season. Consequently, the continuous “exposure to Bt toxins represents one of the largest, most sudden selections for resistance experiences by insects.”⁵⁹³ In laboratory tests, many strains of major pests have evolved with a resistance to Bt toxins. This insect resistance evolved because Bt crops continuously produce toxins, whereas Bt toxin sprays degrade quickly making evolutionary resistance slow and unlikely. The evolution of resistance to Bt sprays and crops outside of the laboratory is documented for only two lepidopteran pests. Evolutionary resistance is a major threat to the future success of Bt crops.⁵⁹⁴ For more information, see section 7.3 *Pesticide Resistance*

7.3 Pesticide Resistance

Due to the widespread use of pesticides, many target species including both insects and plants, have evolved resistance to the pesticides designed to eradicate them. The number of insect species known to display pesticide resistance has increased from less than 20 in 1950 to over 500 as of 1990.⁵⁹⁵ The North American Herbicide Resistance Action Committee and the Weed Science Society of America have recorded over 300 different biotypes that have displayed resistance to one or more herbicides (Graph 21). Of these 300 resistant biotypes, the WSSA estimates that there are over 125 in the U.S. infesting up to 18 million acres.⁵⁹⁶

Graph 21: Growth in Herbicide Resistant Biotypes⁵⁹⁷

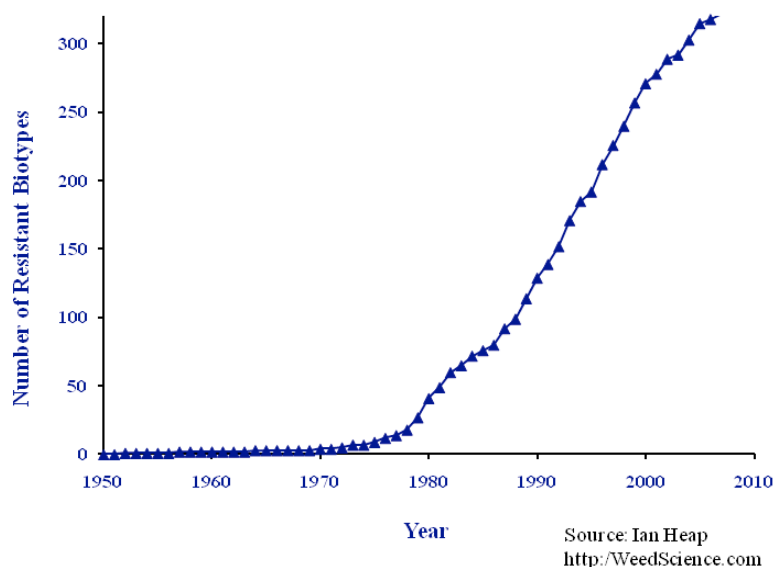

The WSSA states that there are currently four different types of herbicide resistant weeds in Colorado. Local weed scientists estimate that there are 2,260 sites and more than 66,300 acres of barley, corn, and wheat fields infested with herbicide resistant weeds in Colorado. The first herbicide resistant weed reported in 1982 was Redroot Pigweed (*Amaranthus retroflexus*) with resistance to atrazine. The most widespread resistant weed in Colorado is Kochia (*Kochia scoparia*), which evolved a resistance to atrazine (1982), metsulfuron-methyl (1989), and triasulfuron (1989). Wild Oat (*Avena fatua*), with resistance to diclofop-methyl is the most recently discovered (1997) new type of resistant weed in Colorado. While only four resistant weeds have been found in Colorado, over 23 resistant biotypes have been found in Kansas, raising concern that other resistant varieties may transfer to or develop in Colorado.⁵⁹⁸ Weeds that are herbicide resistant have been witnessed in Colorado since 1982, and are not solely associated with the adoption of GE crops.

Glyphosate Resistance

Glyphosate, first commercialized in 1974, has been extensively used for weed control.⁵⁹⁹ The first case of evolved resistance to glyphosate was reported in 1996 in rigid ryegrass (*Lolium rigidum*)⁶⁰⁰ and approximately 18 species have now evolved resistance (Graph 22).⁶⁰¹ According to the National Academy of Sciences, gene flow between herbicide resistant crops and closely related weed species does not explain the evolution of glyphosate resistance in U.S. fields because sexually compatible weeds are absent where corn, cotton, and soybean are grown in the United States. Instead, a number of studies have shown that the near exclusive use of glyphosate for weed control, a practice accelerated by the widespread introduction of glyphosate-resistant crop varieties, has caused substantial changes in weed communities.⁶⁰²

Graph 22: Number of Weeds with Evolved Glyphosate Resistance⁶⁰³
 (*As of March 2010)

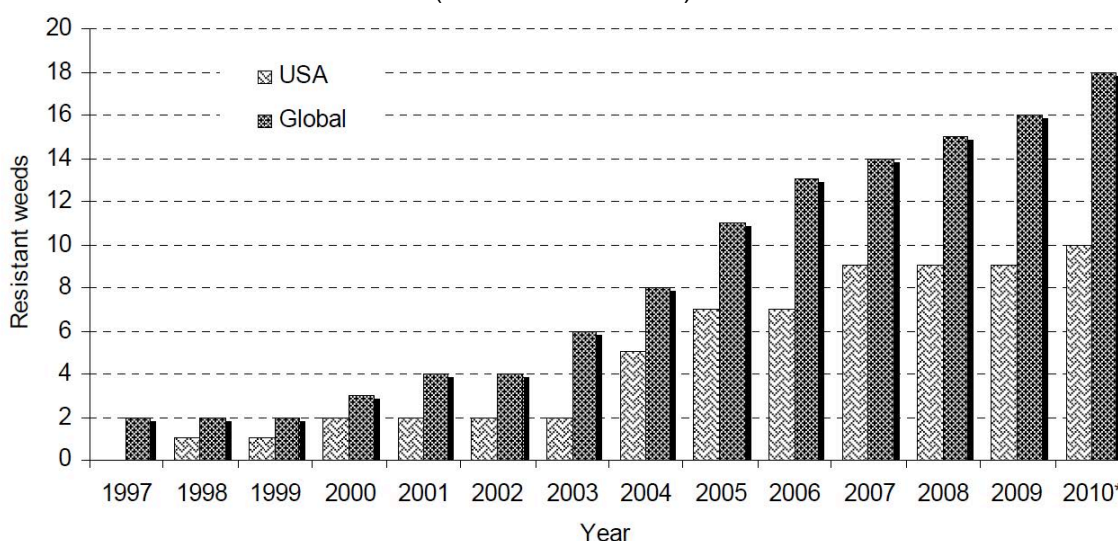

The number of weed species evolving resistance to glyphosate is growing and the number of locations with glyphosate-resistant weeds is increasing at a greater rate as more and more acreage is sprayed with glyphosate. Though the number of weeds with resistance to glyphosate is still small compared to other common herbicides, the shift toward glyphosate-resistant weed biotypes will probably become an even more important component of row-crop agriculture unless production practices (such as recurrent use of glyphosate) change dramatically.^{604, 605, 606} The evolution of glyphosate resistance and weed shifts are estimated to lead to two important changes in agricultural practices, first a general increase in the use of herbicides, and secondly reductions in conservation tillage.⁶⁰⁷ These changes are estimated to increase weed-management costs and potentially reduce producers' profits.⁶⁰⁸

Insect Resistance

Similar to weeds, insects can adapt to toxins and other tactics used to control them.^{609, 610} When Bt crops were first considered for commercial introduction, the U.S. Environmental Protection Agency (EPA) recognized the potential for rapid evolution of insect resistance to Bt toxins produced by GE crops as a threat to the benefits provided by Bt crops and to the efficacy of Bt sprays in organic and conventional production systems alike.^{611, 612} Extensive monitoring of eleven major lepidopteran pests of corn and cotton over the last



14 years has revealed that resistance has evolved in only three pest species, namely cotton bollworm,^{613, 614, 615} fall armyworm,⁶¹⁶ and some populations of corn stem borer.^{617, 618} While these results show limited development of insect resistance, it has been shown that there is usually a delay between the introduction of a novel pesticide and the rapid rise in the number of species that have evolved resistance to it,⁶¹⁹ suggesting that further Bt resistant insects may develop with increased use.

7.4 Integrated Pest Management

There are many natural methods to controlling damaging pests and weeds on farmlands. Integrated Pest Management uses a wide range of methods, encompassing the simultaneous management of multiple pests, regular monitoring of pests and their natural enemies and antagonists, use of economic or treatment thresholds when applying pesticides, and integrated use of multiple, suppressive tactics, like crop rotations and intercropping.^{620 621}

Figure 30: Tillage and Cover Crop Effect on Weed Production⁶²²

Tillage	Cover Crop	Weeds/foot ²	Weed weight pounds/foot ²
Conventional	None	12	0.22
None	None	5	0.14
None	Rye	0.9	0.1
None	Wheat	0.3	0.07
None	Barley	0.8	0.09

Integrated Pest Management is a basic framework used to decide when and how pests are controlled. The primary goal of IPM is to give growers management guidelines in order to make pest control as economically and ecologically sound as possible. In an ecologically-balanced production system, pests are nearly always present, but massive outbreaks easily can be minimized. Natural control agents, like predatory and parasitic insects, mites, and spiders, help to keep pest populations in check. Restoring beneficial populations of pests on the farm through either the elimination or reduced use of pesticides and reduced tillage will help establish habitats and restore populations of beneficial pests.^{623, 624}

Another alternative method to pesticide applications is the use of intercropping. Intercropping is when two or more crops are planted in close proximity to each other to promote a symbiotic interaction.⁶²⁵ Some plants are able to exude chemicals into the surrounding area that suppress or repel pests and protect neighboring plants.⁶²⁶ An additional approach is to plant a neighboring crop that is more attractive to pests than the planted cash crop.⁶²⁷ Despite demonstrated economic and environmental benefits to agricultural production systems from reduced synthetic pesticides, adoption of IPM strategies have been rather slow.^{628, 629}



8. Biodiversity

Summary

The two driving forces affecting terrestrial biodiversity are climate change and agriculture. Traditionally diverse natural ecosystems have been reduced as agriculture has expanded and practices have continued to focus on fewer species of crops and animals. This genetic uniformity was raised as a major concern among researchers due to the potential for increased vulnerability to plant disease, decreased ability to respond to climatic changes, and difficulty recovering from disturbance events. Additional concerns were raised concerning the lack of habitats for pollinators and other beneficial insects, as well as increasing reliance on outside inputs, notably fertilizers and pesticides, to sustain current yields in monocropping systems (the growing of a single crop species on the same field year after year without crop rotation or mixed cropping).

Consensus about the importance of incorporating the value of biodiversity and ecosystem services into agricultural management is increasing, but quantifying the economic value of these services is difficult. It has been estimated that services provided by natural pollinators are over \$14 billion annually in the U.S., but the value of these services to an individual farmer is complicated to measure. As more effective methods for valuing ecosystem services become available, it will become easier to evaluate the value that ecosystem services can provide to agricultural operations.

In agricultural systems, the majority of biodiversity resides in the soil in the form of microbes that help to increase the nutrient and water use efficiency of crops and help suppress disease. Estimates of the services from soil biodiversity have been placed as high as \$1.5 trillion dollars annually. Operations where soil biodiversity is limited have shown decreases in nutrient efficiency, lower drought tolerance, and slow plant growth during times of limited resource constraints.

Additionally, the over application of pesticides in farming systems has been shown to not only decrease weed abundances but also reduce the number of beneficial predators or crop pollinators that provide valuable ecosystem services. Practices such as creating habitats like edge zones, hedgerows, and permanent grass strips and preserving natural small refuge biotopes among cultivated fields can favor natural insect predators. Additionally, methods that disrupt pest cycles, like crop rotations and intercropping, and plant varieties that have high resistance to pests help to limit decreases in biodiversity from synthetic pesticides, while supporting beneficial pests.

Research has been conducted looking at the comparative biodiversity in organic and conventional agricultural systems. The majority of research has demonstrated that both species abundance and richness across a wide range of taxa tend to be higher on organic farms than on locally representative conventional farms. The identified practices contributing to higher rates of biodiversity include a reduced use of all pesticides, better management of non-crop habitats and field margins, and an increased use of crop rotations. These identified practices are not necessarily unique to organic production and the researchers noted that these practices can be incorporated into conventional systems with similar benefits.



8.1 Food Security

As identified by the Food and Agriculture Organization (FAO) “Agricultural biodiversity encompasses the variety and variability of plants, animals and microorganisms at genetic, species and ecosystem levels, which are necessary to sustain key functions in the agro-ecosystem, its structures and processes for, and in support of, food production and food security.”⁶³⁰ Agricultural biodiversity therefore includes not only a wide variety of species and genetic resources, but also the many ways in which farmers can exploit biological diversity to produce and manage crops, land, water insects, and biota. This also includes habitats and species outside farming systems that can benefit agriculture and enhance ecosystem functions.⁶³¹

There are several distinctive features of agricultural biodiversity, compared to other components of biodiversity.^{632, 633}

- Agricultural biodiversity is actively managed by farmers.
- Many components of agricultural biodiversity would not survive without human management.
- Agricultural biodiversity includes providing the building blocks for the evolution or deliberate breeding of useful new crop varieties and the sustainable production of food and other agricultural products.

Developments in agriculture over the last 40 years brought significant increases in global production, due in part to both the expansion of cropland and changes in technologies. With these developments, concerns have risen about the degradation of biodiversity in and around agricultural land. The erosion of agricultural biodiversity is impacted in many different ways and on many different levels, both within farming systems and off farms in natural habitats. As identified in a study from the World Resource Institute, *Linking Biodiversity and Agriculture: Challenges and Opportunities for Sustainable Food Security*, “effective approaches to the conservation of agricultural biodiversity within a general framework of sustainable agriculture have to merge the goals of productivity, food security, and social equity.”⁶³⁴

Genetic Resources

Worldwide, about 7,000 different types of plants are consumed, but of these only about 150 are commercially important, with three crops – rice, wheat, and corn – accounting for 60 percent of calories. The increasing genetic uniformity in agriculture is a concern among researchers because of the increased vulnerability to such things as plant disease and weather resistance.⁶³⁵ The potato blight in Ireland is an historical example of increased vulnerability associated with genetic uniformity.⁶³⁶ This trend of **monoculture** farming (the growing of a single crop species on a field year after year) is unique to the developed world since many of the farms in less developed countries have more plant diversity due to **polyculture** and **agroforestry** practices. Traditional agriculture, which utilizes polycultures, more closely resembles natural ecosystems and can reduce the risk of insect and disease infestations. In some places, these polycrop systems provide the majority of food in that area. For example, in Latin America, 70-90 percent of beans are grown in the same space as maize, potatoes, and other crops.⁶³⁷

The adoption of genetically uniform crops is causing a reliance on an extensive infrastructure of scientists to continually develop more robust crops that can withstand future pests, diseases, and other environmental changes. Additionally, pesticides and other agrochemicals are necessary to keep these monocrops healthy. Scientists argue that maintaining and building biodiversity is essential for future food security.⁶³⁸

The preservation of crops' wild ancestors is important to food security because they are used by breeders for qualities such as disease resistance and vigor, among other traits. This is a real danger being witnessed in the U.S., where an estimated "two-thirds of all the rare and endangered plants are close relatives of cultivated species."⁶³⁹ For example, seven of the eight populations of the grass teosinte, the closest wild relative to corn, are regarded as rare, vulnerable, or already endangered. If these species no longer exist, the future benefits of using them for plant breeding will end as along with their ecological services.^{640, 641}

Beyond food security, a decrease in plant species could have major consequences for the future of both traditional and modern medicine. In North America and Europe, plant derived active ingredients are contained in 25 percent of the prescription drugs on the market.⁶⁴² Beyond industrialized nations' use of traditional herbal therapies,⁶⁴³ the World Health Organization (WHO) estimated that 3.5 billion people in developing countries, who are typically unable to seek modern healthcare, rely on plant-based medicine for their primary source of health care.⁶⁴⁴

Seed Banks

In the 20th century, efforts towards conserving endangered flora and fauna include botanical gardens, nurseries, and gene banks. These approaches usually consist of moving the species to a location outside of their habitat, referred to as ex situ conservation. Relatives of crop varieties are mainly preserved in gene banks. More than 90 percent of all gene bank accessions are of food and commodity plants, particularly the world's most economically valuable and intensively bred crops.⁶⁴⁵ When there are large collections of individual species by multiple facilities, the odds are much higher that one of those samples will be viable in future generations.⁶⁴⁶ The National Center for Genetic Resources Preservation is a United States Department of Agriculture (USDA) Agricultural Research Service facility located on the campus of Colorado State University in Fort Collins. Its mission is "to acquire, assess, preserve, and provide a collection of genetic resources to secure the biological diversity that underpins economic and environmental sustainability of agriculture through research, stewardship, and communications."⁶⁴⁷

Saving samples in gene banks, however, does not imply future food security since gene banks are expensive to operate and underfunded, meaning not every seed can be kept in optimal condition. For example, if seeds are not kept in cold storage they can lose viability within a few years. Gene banks focus on ex situ, not in situ, conservation and consequently there will be a loss of many species if in situ methods are not advocated.⁶⁴⁸ Gene banks are only a piece of conservation and cannot solve the other problems associated with decreasing biodiversity. For example, if seeds are saved, but the pollinators become endangered or extinct, then the whole system would not be able to function without human intervention. Plant diversity can only be protected if the ecosystem is preserved to allow species to evolve and adapt naturally.⁶⁴⁹

8.2 Impact of Reduced Biodiversity

Agriculture and climate change pose risks to terrestrial biodiversity. In agricultural ecosystems, biodiversity performs a variety of ecological services beyond the production of food, including recycling of nutrients, regulation of microclimate and local hydrological processes, suppression of undesirable organisms, and detoxification of noxious chemicals.^{650, 651} Increasingly, there is consensus about the importance of incorporating ecosystem services into resource management, but quantifying the economic value of these services is difficult. For example, forest cover provides a service of water catchment to recharge reservoirs and aquifers that are used for irrigating agriculture, which can be just as much a service to agriculture as the funding of irrigation equipment and infrastructure.⁶⁵²

Without quantitative assessments, and some incentives for landowners to provide them, the recognition of these ecological services has been slow.⁶⁵³ As more effective methods for valuing ecosystem services become available, it will become easier to realize the benefits of ecosystem services and identify cost effective means of improving agricultural ecosystems.⁶⁵⁴

Certain agricultural practices have the potential to enhance biodiversity, while others negatively affect it. Farming practices that create a more diverse farming system, like polycultures and rotating crops, can decrease pest infestation, while practices, like monocultures and conventional tilling, can increase pest infestation (Figure 31).⁶⁵⁵

Figure 31: Environmental Effects of Agroecosystem Management on the Biodiversity of Pests⁶⁵⁶

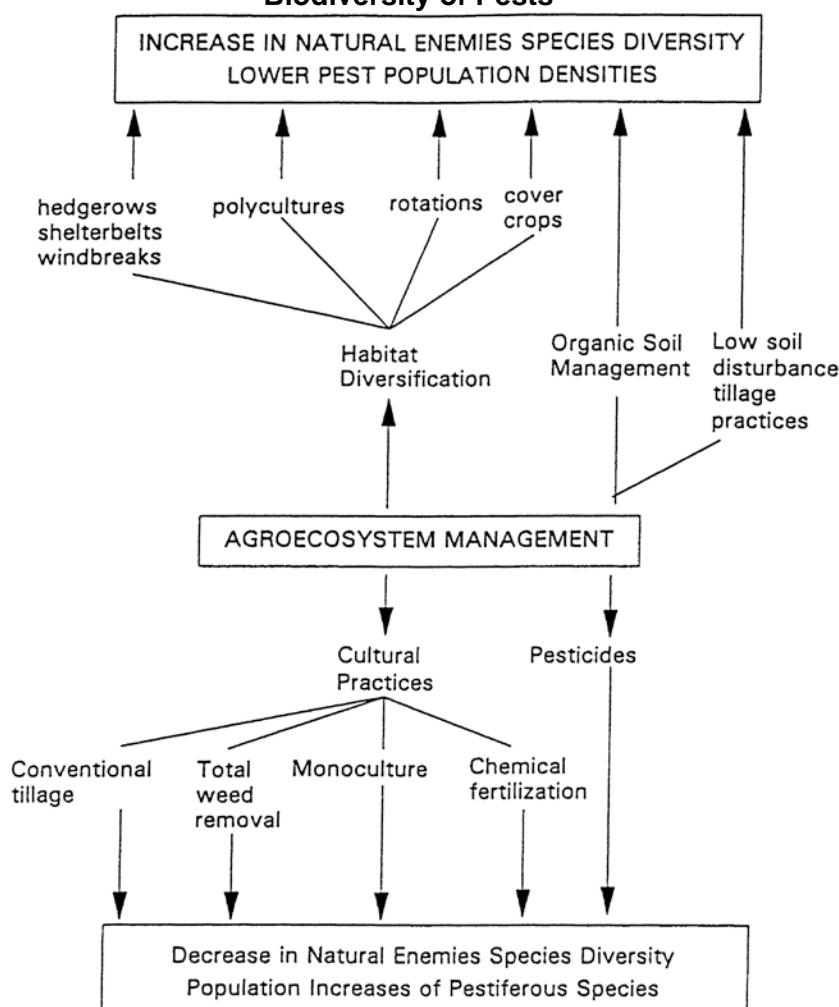

Species Loss

The extinction of species is a natural phenomenon that has been accelerated in the last century from one to ten species per year, to 1000 species per year. Scientists believe that the last time this sort of mass extinction happened was 65 million years ago, when dinosaurs disappeared. According to the World Conservation Union, "one out of every eight plants surveyed is potentially at risk of extinction."⁶⁵⁷

There are an estimated ten million species on earth, which contain a total of 2.2 billion populations. Extinction of a population is an extinction of a species in a given region, while the extinction of species is the total world disappearance of that species. The extinction of populations is happening at a significantly fast rate of hundreds per day.⁶⁵⁸ The U.S., Australia, and South Africa have the most species at risk of extinction, but those figures could be deceiving since those countries may track dwindling species more closely.⁶⁵⁹



The unintended effects of genetically engineered crops on non-target organisms could affect future biodiversity. For example, *Bacillus thuringiensis* (Bt), a pesticidal property found in some varieties of genetically engineered (GE) crops, may negatively affect populations of butterflies and moths.⁶⁶⁰ A laboratory study found that pollen from Bt corn caused high mortality rates in monarch butterfly caterpillars. Even though monarch butterfly caterpillars do not consume corn, they consume milkweed plants, which can contain Bt pollen that drifted from a neighboring farm. The results of the current studies are still being debated, and there is no agreement about the potential risk on non-target organisms.⁶⁶¹

Genetically engineered crops may put pollinators at risk, and many crops depend on insects for pollination. Pollinators are both 'managed' species, such as honey bees, and wild species of bees, flies, beetles, and other insects. Only studies on managed species have been performed. There are two ways that GE crops can impact pollinators, either directly posing a hazard to the pollinator, or indirectly by changing its habitat. Bt crops have insecticidal proteins, which are more likely to affect pollinators directly. The experiments conducted on honey bees and bumblebees have shown no adverse effects of Bt crops. The results of studies on the effects of new insecticidal GE crops on non-target organisms currently under development have not been released.⁶⁶²

Soil Microbial Communities

The majority of biodiversity in agricultural systems resides in the soil. Interactions among the soil biota have large effects on the quality of crops, the incidence of soil-borne plant and animal pests and diseases, and the beneficial organisms that help cycle nutrients or act as predators for unwanted pest species.⁶⁶³ The available evidence suggests that soil biota biodiversity provides multiple benefits to agricultural production including: (1) conferring disease suppressiveness, (2) providing resistance and resilience against disturbance and stress, and (3) increasing nutrient and water use efficiency. The extent to which these benefits are provided by soil biota is the source of debate as a range of field conditions can affect the value of benefits. Efforts to quantify the impact economically of both direct impacts (organisms themselves and metabolic products) as well as indirect impacts (the long-term outcome of their activities), have estimated that soil biodiversity provides services valued at over \$1.5 trillion dollars.^{664, 665}

Figure 32: Managing Biodiversity^{666, 667}

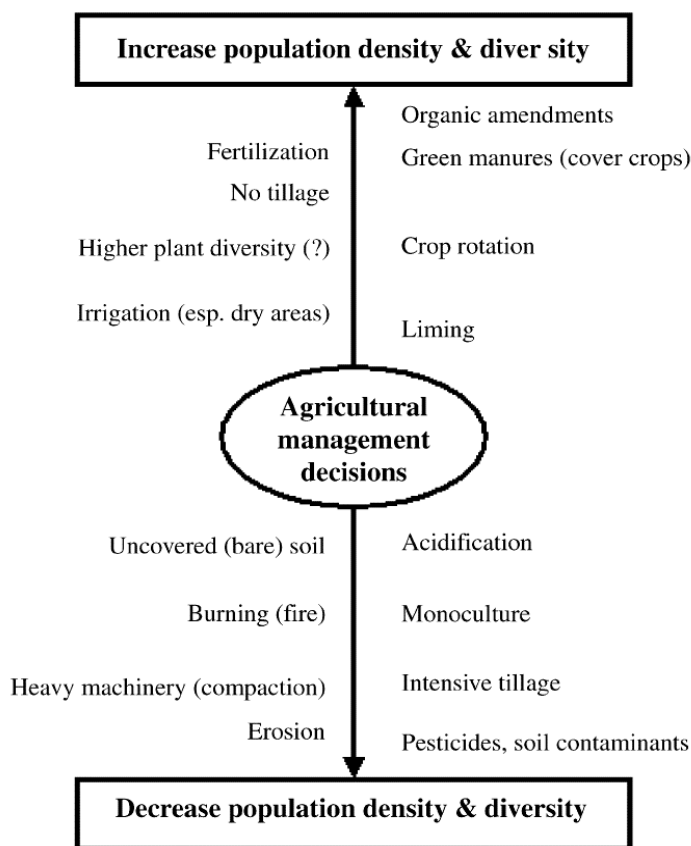

In operations where soil biodiversity is limited, a decrease is seen in nutrient efficiency, drought tolerance, and plant growth during times of resource constraints.^{668, 669, 670} A number of management practices have been shown to increase the activity and diversity of soil biota. Some of these practices are shown in Figure 32, but the greatest benefits have come from the proper choice and distribution of crops, the enhancement of natural pest and disease resistance through plant selection, and management of organic matter and external inputs (e.g. fertilizers).^{671, 672, 673} In comparison to conventionally cultivated soils, using conservation tillage and maintaining crop residue cover on the soil surface benefit below ground food webs and processes.^{674, 675}

8.3 Management

Agricultural ecosystems are usually designed for one or several species of plants or animals with multiple efforts to reduce diversity, compared to natural systems, in order to increase the production of food.⁶⁷⁶ Biodiversity in agricultural operations comprise both the planned biodiversity (the crops and/or livestock the farmer wishes to produce) and the unplanned biodiversity (all other biota in entering the system). The unplanned biodiversity may be considered beneficial, such as insects pollinating a crop, or harmful, such as pathogens, pests, and weeds.⁶⁷⁷

Pesticides

Pesticides are an integral part of modern farming and strongly impact the level of biodiversity within agricultural operations. A number of studies have shown that the use of pesticides have had a negative impact on the both the number and activity of non-target animals and plants. The most evident consequence of biodiversity reduction is witnessed in pest management. Insect pest problems are in part due to the expansion of crop monocultures. Decreases in the number of diverse plants that support natural enemies or directly inhibit pest attacks are a contributing factor to insect infestation. A greater number of internal links are made in an undisturbed diverse agroecosystem, creating a greater possibility of insect stability due to the many natural forms of insect management that are created.⁶⁷⁸ For example, the application of herbicides in conventional farming systems will, by their nature, decrease weed abundances, but may have subsequent deleterious effects on insects and birds by removing species on which they depend.⁶⁷⁹ Similarly, the use of insecticides will not only decrease pest insects but also the predators that feed upon them.⁶⁸⁰

Additionally some synthetic and organic insecticides kill bees and other beneficial pollinator species that are non-target victims, increasing reliance on managed or hired pollinators. Managed pollination is a \$10 billion a year industry in North America and relies on just two species of bee compared to the 5,000 wild bee species present. Many of these wild species have mostly disappeared from agricultural lands, due primarily to insecticides, a lack of floral diversity, destruction of habitats, and competition with managed pollinators.⁶⁸¹

The number of honey bee colonies on U.S. farmland dropped from just over four million in 1985 to less than two million in 1997, due in large part to the direct and indirect effects of insecticides. Exposure to insecticides used by commercial beekeepers to control the brood parasite (*V. destructor*) the cleptoparasitic small hive beetle (*A. tumida*) and the wax moth (*G. mellonella*) have been shown to impair associative learning and immune systems in honey bees making them more vulnerable and disrupting their reproduction and development. This has lead some to theorize that some insecticides like apistan, coumophos, amitraz used to combat the aforementioned pests in honey bee colonies and imidacloprid used to control sap-sucking insects in crops and blood-sucking insects in companion animals could be contributing factors to colony collapse disorder.⁶⁸² Additionally, studies show that insecticides and herbicides have also eradicated food sources for non-pollinators, including bird species, contributing to a further decline in populations.⁶⁸³

Colony Collapse Disorder

In colony collapse disorder (CCD), honey bee colonies inexplicably lose their workers. Since the late 1940s, the number of honey producing bee colonies has been decreasing as shown in Graph 23.⁶⁸⁴ Colony collapse disorder has resulted in a loss of 50 to 90 percent of colonies in beekeeping operations across the United States.⁶⁸⁵ The syndrome is mysterious in that the main symptom is simply a low number of adult bees in the hive. There are no dead bodies in the hive, and although there are often many disease organisms present, no outward signs of disease, pests, or parasites exist. Numerous causes of CCD have been proposed, often with little or no supporting data.⁶⁸⁶ A study conducted in 2007 looked at more than 200 variables potentially causing CCD and 61 were found with enough frequency to permit meaningful comparisons between populations, but no clear cause of CCD was identified.⁶⁸⁷

Graph 23: Number of Honey Producing Colonies in the U.S.⁶⁸⁸ (Data were not available from 1982 to 1985)

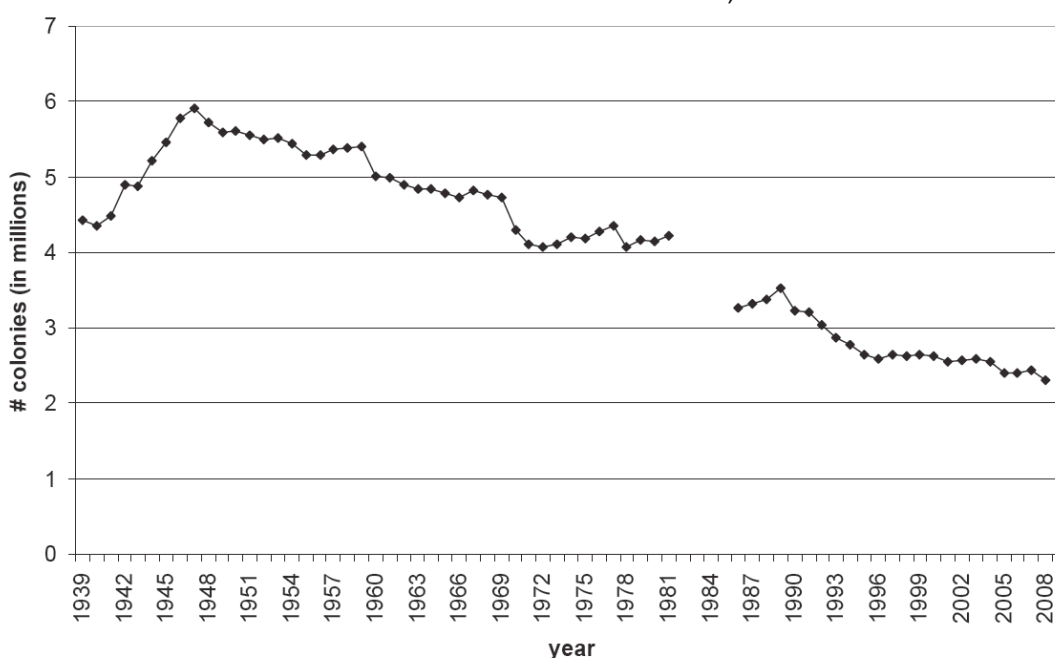

At present, the cause of CCD in U.S. bee colonies remains under investigation, as a number of realistic and conceivable hypotheses remain plausible. The primary hypotheses (in no particular order) include:⁶⁸⁹

- Traditional bee pests and pathogens
- How the bees were managed (management stress)
- Queen source (poor genetic biodiversity)
- Chemical use in bee colonies to control bee pests / pathogens
- Chemical toxins present in the environment
- Mites (*V. destructor*) and associated pathogens
- Bee nutritional fitness
- Undiscovered / newly discovered pests and pathogens or increasing virulence of existing pathogens
- Potential synergistic interactions between two or more of the above hypotheses.

As highlighted by the International Bee Research Association:⁶⁹⁰

“The effects of colony losses in general and CCD specifically in the U.S. are significant, especially considering the increasing demand for pollination in agriculture. The value of honey bees to U.S. agriculture has been estimated to be [greater than] \$US14 billion,⁶⁹¹ principally through pollination of many of the nation’s crops. Consequently, large scale research efforts have begun in the U.S. to determine the underlying cause(s) of colony losses, including CCD, in an attempt to mitigate or slow the rate of losses.”

Methods of pest management that help to decrease the use of chemical pesticides while increasing biodiversity rely heavily on integrated pest management systems. By using biologic methods, and chemical pesticides only as a last resort, IPM approaches have been able to keep destructive insects under control. For example, creating habitats such as edge zones, hedgerows, and permanent grass strips and preserving natural small refuge biotopes among the cultivated fields can favor natural insect predators.⁶⁹² Additionally, methods that disrupt pest cycles, like crop rotations and intercropping, and plant varieties that have high resistance to pests help to limit decreases in biodiversity from chemical pesticides.⁶⁹³ For a further discussion on managing pests and IPM please see 4.1 *Integrated Pest Management*.

Production Methods Affecting Biodiversity

Many factors influence the biodiversity in an agricultural landscape, of which only some are clearly related to the organic farming system. To a great extent, these factors are under the control of individual farmers allowing land to be managed to increase the abundance of beneficial organism groups regardless of the type of agriculture. A comprehensive assessment of how organic agricultural methods effect biodiversity compared to conventional systems found that the majority of the 76 studies reviewed demonstrated that species abundance and richness across a wide range of taxa tend to be higher on organic farms than on locally representative conventional farms (Figure 33).⁶⁹⁴

Figure 33: Summary of the Effects of Organic Farming on Individual Taxon, in Comparison to Conventional

Taxon	Positive	Negative	Mixed/No Difference
Birds	7	0	2
Mammals	2	0	0
Butterflies	1	0	1
Spiders	7	0	3
Earthworms	7	2	4
Beetles	13	5	3
Other arthropods	7	1	2
Plants	13	0	2
Soil Microbes	9	0	8
Total	66	8	25



The authors identified three broad practices strongly associated with organic farming that benefited farmland biodiversity: (1) the reduced use of chemical pesticides and inorganic fertilizers, (2) management of non-crop habitats and field margins can enhance diversity and abundance of arable plants, invertebrates, birds, and mammals, and (3) the use of crop rotations and mixed farming positively impact farmland biodiversity through the provision of greater habitat heterogeneity at a variety of temporal and spatial scales within the landscape.⁶⁹⁵

The identified practices are not necessarily unique to organic production. The authors acknowledged that through the above practices it is possible for a conventional farm to sustain equivalent levels of biodiversity as those found on organic farms, suggesting that increases in biodiversity may potentially be a result of identifiable changes in management.⁶⁹⁶

9. Labor

Summary

As advances in technology have continued to increase the efficiency of agricultural production, there has been a steady decrease in farm employment. Agriculture used to account for roughly seven to eight percent of the workforce in Colorado, but now it represents only about two to three percent of the State's workforce, providing 100,000 direct jobs. Farmers in Colorado have reported a shortage of labor, with labor shortages resulting in an estimated loss of \$60 million in 2006. The H-2A visa program is a national attempt to fill these shortages by allowing temporary entry for foreign workers. Recent estimates show that there are more than 9,000 migrant workers in the state of Colorado, with 50-75 percent of these workers not having official documentation. Analyses of the regional economic impact of a migrant workforce have been conflicting, with concerns relating to the impacts of a reduced labor supply or the low buying power of migrants.

In Boulder County, the average age of a farmer was 59.4 years in 2007, reflecting a higher average age than both the State of Colorado as a whole and the national average. This increase in age reflects a changing pattern of employment with principal operators continuing to work well past standard retirement ages as well as a drop in interest from younger farmers who are increasingly pursuing careers outside of agriculture. While there has been an overall increase in the average age of farm workers there has been a strong growth of female operators (10 percent increase 2002-2007) in Boulder County. Female operators now represent about a quarter of all farm operators in the County and tend to have smaller and more diversified operations.

While the average farm household income is comparable to that of the national median income, farmers increasingly have to derive the majority of their income from non-farming activities. In Boulder County, 73 percent of operators reported having worked off the farm for a secondary source of income.

Farm workers (not including operators) are a major asset to agricultural operations because they provide labor during critical agricultural production periods, however they are traditionally one of the most economically disadvantaged groups in the U.S., with lower rates of compensation compared to other low-skilled jobs. Additionally farm workers tend to be at a higher risk of poverty and are more likely to be injured or killed on the job than just about any other profession.

The Agricultural Health Study is a leading long-term study that looked at health impacts, particularly cancer rates, for the agricultural workforce. The study found that while the occurrence of cancer for farmers is generally lower than the general population, farmers may have an increased likelihood of developing certain types of cancer due to farm-related occupational exposure. Specific types of cancer that were found to be in excess in the studied farm workers included lymphohematopoietic cancers, prostate cancer, melanoma, ovarian cancer, and brain tumors.

9.1 Agricultural Employment

Nationally, farm workers account for less than one percent of all U.S wage and salary workers. The majority of farm work, 70 percent, is performed by paid or unpaid family members, while only 30 percent is performed by hired farm workers.⁶⁹⁷ Agriculture used to account for roughly seven to eight percent of the workforce in Colorado⁶⁹⁸ and now represents only about two to three percent of the State's workforce.⁶⁹⁹ As advances in technology have continued to increase the efficiency of agricultural production, there has been a steady decrease in farm employment, as shown in Graph 24. At present, the agricultural sector provides about 100,000 jobs in Colorado, employing three percent of the workforce, less than the national average of four percent in 2009.⁷⁰⁰

Graph 24: Farm Employment (Full and Part-time), U.S. and Rockies Region, 1969 - 2000⁷⁰¹

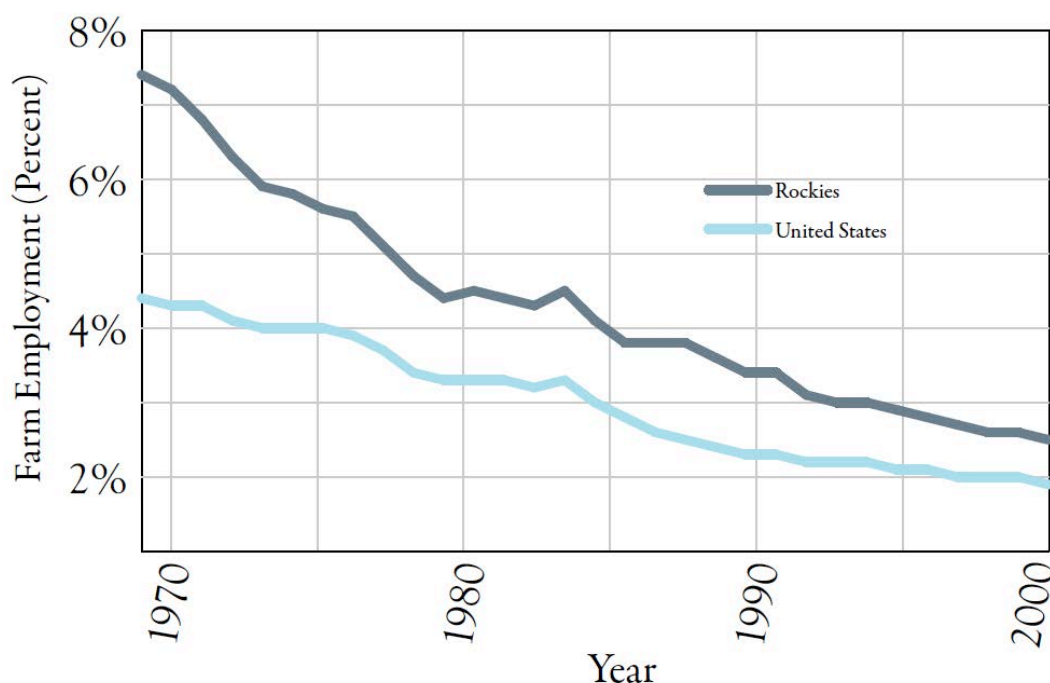

Labor Supply and Status

In recent years, Colorado farmers have reported a shortage of labor. Labor shortages can have profound economic impacts on more specialized operations, where labor can account for 30-40 percent of operation expenses.^{702, 703} In 2006, labor shortages resulted in an estimated loss of \$60 million.⁷⁰⁴ Analyses of the regional economic impact of a migrant workforce have been conflicting. Some analysts argue that elimination of undocumented workers will have adverse long-term consequences due to a loss of labor and economic output.⁷⁰⁵ Others have argued that migrant workers (whether legal or not) carry a lower buying power due to their temporary status in a community and the fact that many send some portion of their earnings to family members in their home countries. For example, of the \$48,561,662 earned by Hispanic workers in Weld County's meat packing industry, five percent went towards property and income taxes and 3.5 percent went to remittances to home countries, leaving an approximate \$44.5 million (91.5 percent) for savings and disposable income. While some of this income will



go towards housing, food, and other miscellaneous expenses, temporary status in the community increases the likelihood that a majority of that income will be spent outside of the region.⁷⁰⁶

The H-2A visa program is a national attempt to fill labor shortages in the agricultural sector by allowing temporary entry for foreign workers. Recent estimates show that there are more than 9,000 migrant workers in the state of Colorado – only a small fraction of which hold H-2A visas – and 50-75 percent of the workforce is believed to have “questionable documentation.”⁷⁰⁷ In 2007, 237 Colorado employers submitted 1,953 H-2A worker requests; all but 28 were approved. Operators who have participated in the H-2A program have cited significant problems with the process, however, including:⁷⁰⁸

- Slow processing of requests (averaging 168 days as of 2009)
- Increased costs (one operator reported an annual \$2,400 application fee, \$300 per worker for visas and security certification, \$160 in round-trip transportation, and an hourly wage of \$8.64 vs. the previous wage of just over \$7.00)
- Complicated applications

Colorado House Bill 1325 was signed in 2008 in an attempt to address some of these issues and expedite the H-2A application process. The goal of the bill is to reduce processing time to less than 60 days by hiring recruiters in Mexico to attract workers and help process paper work, ultimately promoting a legal route to working in the state of Colorado. Despite previous attempts at encouraging legalized work through temporary work programs, the population of illegal immigrants has continued to rise throughout the nation. HB 1325 is not expected to have a significant impact on curbing the illegal immigrant population, however, it is expected to help fill the labor gap in Colorado’s agricultural sector.⁷⁰⁹

9.2 Demographics

During the last 20, years the average age of U.S. farm operators has increased from 52 to 57, representing over a 10 percent increase.⁷¹⁰ In 2007, the average age of farmers in Boulder County was 59.4 years of age (Figure 34),⁷¹¹ higher than both the State of Colorado and national average.⁷¹² As a region, the Rockies have seen a large increase in the number of farmers over the age of 70, representing an increase of 114 percent since 1987. This increase, which is double the national average, reflects a changing pattern of employment with principal operators continuing to work well past standard retirement ages as well as a drop in interest from younger farmers who are increasingly pursuing careers outside of agriculture.⁷¹³

Figure 34: Distribution of Farm Ownership by Age for Boulder County⁷¹⁴

% of Farms by Age of Primary Operator (2007)	
Under 25 Years	0
25 to 34 Years	1.5
35 to 44 Years	8.4
45 to 59 Years	27.7
55 to 59 Years	11.8
60 to 64 Years	14.5
65 to 69 Years	12.9
70 Years and Older	23.2

Principal farm operators in Boulder County are predominantly male. While females account for only about a quarter, 26 percent, of all farm operators, they represent the strongest growth of new operators. The number of women farm operators in the County has increased almost ten percent since 2002, while the number of male operators has declined one percent.⁷¹⁵ This increase in female farmers is consistent with national patterns, trend that has been accelerating for the past two decades, as shown in the 2007 Census of Agriculture.⁷¹⁶

Between 1987 and 2007, the number of female operators in the U.S. increased by 133 percent, while the number of male operators decreased by three percent.⁷¹⁷ This change reflects that women are responsible for a significant portion of new farm growth and a larger shift in traditional gender roles of farm operators. On average, farms run by women operators in Boulder County are roughly half the size of those run by male operators and reflect a more diversified mix of crops.⁷¹⁸ A profile of operators by race shows the typical operator is white with fewer than three percent of operators in the county being a race other than white.⁷¹⁹

Tenure and Ownership

Despite recent growth in beginner farmers, particularly women, the increase is still too small to offset declining numbers. The length of time farm operators have been working on their current farm in Colorado, and subsequently Boulder County, is considerably higher than it was 60 years ago. In the Rockies region, the percentage of operators who had been on their farm for less than five years was 39 percent in 1945, while, as of the latest census, only seven percent had operated their farm for less than five years in 2007.^{720, 721} At present, the average tenure of farmers in Boulder County is 19.2 years, with only four percent of newer famers having been on their current farm for two years or less.⁷²²

Figure 35: Change in Farm Tenure from 1945 to 2007^{723, 724}

		Colorado	Boulder County
1945	Five Years or less	46%	Data Not Available
	5 to 9 years	17%	
	10 years of more	36%	
2007	Five Years or less	11%	10%
	5 to 9 years	18%	17%
	10 years of more	71%	73%

9.3 Occupational Health and Performance

Farm workers are a major asset to agricultural operations because they provide labor during critical agricultural production periods, however, they are one of the most economically disadvantaged groups in the U.S.^{725, 726} Compared to other low-skill jobs (Figure 36), farm workers receive lower rates of compensation, averaging \$350 - \$425 a week. The average national agricultural wage in 2006 was \$9.87 an hour, including the compensation of managers and supervisors.⁷²⁷ Accounting only for non-supervisory positions, the average rate of compensation drops considerably to \$6.25 an hour. The relatively low rates of compensation for farm workers is, according to the United States Department of Agriculture (USDA) Economic Research Service (ERS), a partial result of a lack of other work opportunities for unauthorized workers.⁷²⁸

Figure 36: Comparison of Low-skilled Compensation Rates⁷²⁹

Occupation	Median weekly earnings (dollars)
Dishwasher	\$320
Crop Farmworker	\$350
Maid	\$360
Groundskeeper	\$400
Janitor	\$420
Livestock Farmworker	\$425
All Low-Skilled	\$480
Security Guard	\$480
Material Mover	\$480
Construction Worker	\$520

As a result of lower compensation rates, farm workers are at a higher risk of poverty than any other occupation. Already, 12 percent of people working in farming, fishing, and forestry occupations were in poverty, as shown in Graph 25.⁷³⁰

Graph 25: Percent of Workforce in Poverty by Occupation⁷³¹

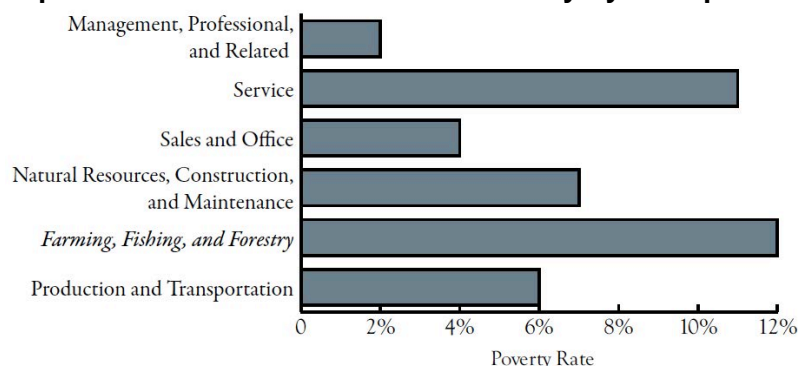

In addition to high poverty rates, unemployment rates for farmers are greater than the national average for all other occupations (Graph 26).⁷³² The USDA ERS attributes the high unemployment rates to the seasonality of farm work. On average, hired farm workers are employed for roughly the same number of weekly hours throughout the year, but the number of hired farm workers at any one time varies significantly through



the year.⁷³³ The National Agricultural Statistics Service data in 2006 indicated that 1,195,000 hired farm workers were employed in mid-July, compared with only 796,000 in mid-January.⁷³⁴

Graph 26: U.S. Unemployment Rates by Occupation in 2006⁷³⁵

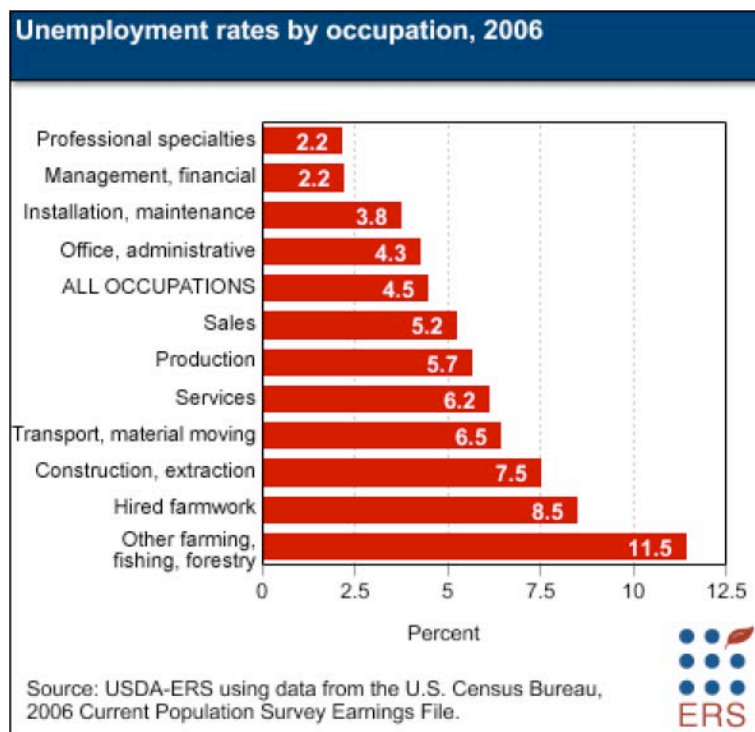

The USDA reports that across the United States farmers' household income is comparable to that of the national median income.⁷³⁶ However, a majority of this income is derived from non-farming activities, as presented in Graph 27. In this study, many farmers indicated that farming was not their primary occupation because off-farm activities contributed much more to their annual income.

Graph 27: Average Farmer Household Income by Source from 1998-2004⁷³⁷

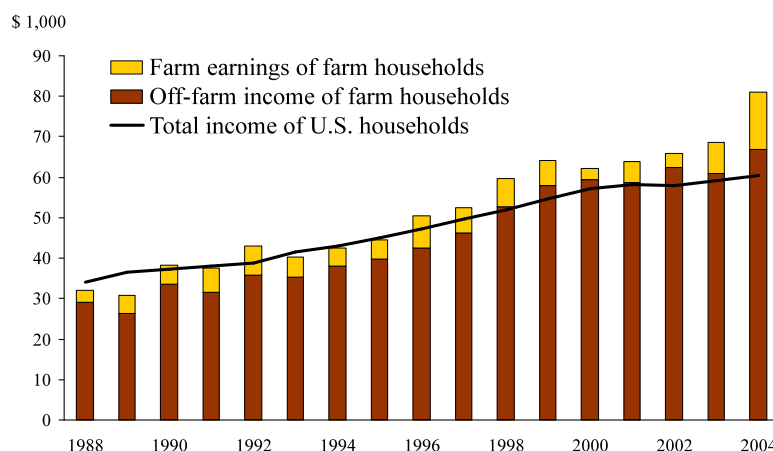

In addition to an overall decline in agricultural employment, farm operators are increasingly utilizing off-farm jobs for a source of secondary income. In Boulder County, 73 percent of operators reported having worked off the farm for a secondary source of income according to the 2007 Agricultural Census. The frequency of days worked off the farm increased for nearly all categories from 2002 to 2007 as shown in Figure 37.⁷³⁸

Figure 37: Frequency of Non-Farm Work for Farm Operators in Boulder County⁷³⁹

Days Worked Off Farm	2007	2002
Zero Days	200	330
1 to 49 Days	154	70
50 to 99 Days	42	19
100 to 199 Days	74	39
200 Days or More	276	278

The rise in off farm employment is largely attributed to the need for extra income to maintain the farm and the need for employer sponsored health care coverage.⁷⁴⁰ Due to the large prevalence of self-employment by farm operators and small businesses in rural areas, adults are less likely than those in urban areas to have health insurance through their employers.⁷⁴¹ Additionally, as smaller farms continue to face competition from larger farms, second jobs and urban markets for agricultural products help to provide a cushion for smaller operations.

Health Issues

The Agricultural Health Study (AHS) is a leading long-term study funded and directed by the National Cancer Institute, the National Institute of Environmental Health Sciences, the US Environmental Protection Agency, and the National Institute for Occupational Safety and Health. The study focused on the effects of environmental, occupational, dietary, and genetic factors on the health of the agricultural population.⁷⁴²

The overall cancer occurrence among farmers and their spouses was found by the AHS study to be significantly less than that of other non-farm men and women of the same age. This was attributed to less frequent use of tobacco products by farmers and a greater frequency of physical activity on the job than the general population.⁷⁴³ While the occurrence of cancer for farmers is generally lower, the AHS study found that farmers may have an increased likelihood of developing certain types of cancer due to farm-related occupational exposures.^{744, 745}

Specific types of cancer that were found to be in excess in the studied farm workers included lymphohematopoietic cancers, prostate cancer, melanoma, ovarian cancer, and brain tumors.^{746, 747, 748, 749, 750} The increase of specific cancer rates among agricultural populations has been linked to exposures to sunlight, dusts, pesticides, and other chemicals present on the farm. The specific contributions from each of these factors towards the development of cancer in farm workers are not entirely certain and require additional research and analysis.⁷⁵¹



Injuries and Fatalities

The occupational environment of the agricultural industry presents a wide variety of hazards to workers, making the industry one of the most prone to worker injuries and fatalities.⁷⁵² Common hazards include animals, physical labor, chemical exposure, working with heavy machinery, and risk of heat stroke.^{753, 754}

Farm operations that have been reported to be more risky than others include dairy, forestry, and beef cattle.⁷⁵⁵ Other characteristics associated with increased risk of injury are the age of farm workers, season (spring and fall are high risk seasons), size of the farm, number of years in farming, and off-farm paid employment.⁷⁵⁶

The fatal injury rate for farmers is one of the highest per occupation at 40.3 fatal injuries per 100,000 full time equivalent workers (FTE), while the average for all occupations is 3.7 fatal injuries per 100,000 FTE.⁷⁵⁷ The highest percent of agricultural fatalities, 52 percent, is represented by workers 55 years of age and older. Older workers are significantly more at risk, three times more than the next highest agricultural fatalities age group. This increased risk is mostly due to older farmers continually working past what is considered a standard retirement age, sometimes even to advanced age, 65 or older.⁷⁵⁸

The most common sources of fatalities are tractors (37 percent), trucks (10 percent), and harvesting machines (4.4 percent). These three equipment-related causes of death represent over half of the fatalities in agricultural production. As seen in Figure 38, the most common fatal injury events were overturning vehicles/machines, fall-from and run-over-by vehicle or machinery, and caught in running equipment.⁷⁵⁹

Figure 38: Common Fatal Injury Events Among Farm Workers⁷⁶⁰

Fatalities by Type of Injury Event	Percentage
Overturning vehicle/machine	25.8
Fall from & runover by veh/mach.	7.3
Caught in running equipment	6.8
Struck by falling object	5.7
Run over (pedestrian)	5.2
Fall to lower level	4.2
Struck by rolling objects	3.3
Assault by animal	3.2
Suicide	2.2
Caught in collapsing material	2
All other events	34.3

Farming is one of the few industries in which families are also at increased risk. According to the latest Census, an estimated 1.26 million children and young adults under 20 years of age live on farms, and about 725,000 of them work on the farms in some form.⁷⁶¹ The National Agricultural Statistics Service and the National Institute for Occupational Safety and Health found that, on average, reported injuries are sustained by roughly five percent of these children and young adults, and 63 percent of these injuries occur from non-work related accidents.⁷⁶²

10. Human Health

Summary

Agriculture can present several risks to human health through the food supply from management and growing practices. One of the most studied risks is the potential for the transfer of food borne pathogens from animal wastes. When animal wastes are concentrated in high amounts and not managed correctly, they can present significant problems during handling, use, and disposal, posing both health and environmental risks. A variety of different viruses can be present in animal fecal wastes and manures and have been documented to make their way into the food supply via contaminated crops.

It has been estimated that about 70 percent of all of the U.S. antimicrobials produced are fed to animals to help promote growth and treat disease. This frequent use and high volume of antimicrobials has greatly increased the development of drug resistant strains of disease, causing several outbreaks of heavily drug resistant diseases in the human population. The National Research Council and Institute of Medicine found that there is a strong link between the use of antimicrobials in food animals and the development of bacterial resistance to these drugs. Despite the demonstrated increases in bacterial resistance due to antimicrobial use, the overall risk and frequency of incidences of such diseases has been shown to be low.

At present, more than 800 pesticide active ingredients from a wide range of commercial products are registered for use in agricultural operations. Pesticides have been shown, by the Environmental Protection Agency, to negatively impact human health through both short and long-term effects. The more serious long-term effects of pesticides can include disruption of the body's reproductive, immune, endocrine, and nervous systems, as well as elevated cancer risks. The overall impact of a pesticide on human health and the environment depends on several factors, including its behavior in the environment, its ecotoxicity, and the amounts applied.

The National Institute of Science evaluated the likelihood for unintended health effects to occur as a result of various methods of genetic modification. Overall, the committee found that the process of "genetic engineering has not been shown to be inherently dangerous, but rather, evidence to date shows that any technique, including genetic engineering, carries the potential to result in unintended changes in the composition of the food." One of the major health concerns with genetically engineered food is its potential to increase allergies in the human population through the food chain. To date, no commercially available biotech proteins in foods have been documented to cause allergic reactions, though a number of studies have raised concerns of potential implications for allergic reactions or shown allergic reactions in non-commercially available crops. Despite these studies showing the potential for allergic reactions, or even specific cases of identified allergens, no commercially grown genetically engineered (GE) crop has been shown to cause allergic reactions owing to a transgenically introduced allergenic protein or a significant increase in the **endogenous allergenicity** of a crop.

10.1 Food Safety

Animal Waste

Animal wastes, when concentrated, can present significant problems during handling, use, and disposal, posing both health and environmental risks. A variety of different viruses can be present in animal fecal wastes and manures. Exposure of humans to these disease-causing pathogens of animal origin can occur via occupational exposure, water, food, air, or soil.⁷⁶³ Generally, direct animal-to-human transmission via animal wastes is not as high a risk as bacterial transmission through the food supply. However, animal-to-animal transmission or herd-to-herd transmission of viruses is a concern.⁷⁶⁴

Manure can contain high concentrations of pathogens, which can affect both animal and human health.^{765, 766} Manure runoff from livestock operations into water supplies has been associated with a number of health concerns including *Salmonella* and *Cryptosporidium* outbreaks, and dangerous levels of nitrates - potentially fatal to infants.⁷⁶⁷ Manure runoff from livestock operations is among the suspected causes of outbreaks of *Pfiesteria piscicida* in a number of states, causing human health effects including acute short-term memory loss, cognitive impairment, asthma like symptoms, liver and kidney dysfunction, blurred vision, and vomiting.⁷⁶⁸

In concentrated amounts, or when improperly handled, manure can present health risks to humans, but when used as part of an integrated system like pastoral production, wastes can be used as an important input. For example, animal wastes could be treated through composting to create a crop fertilizer that no longer harbors pathogens, and that, when applied at appropriate rates and times with methods that minimize nutrient leaching, can help to reduce pollution and health risks. Additionally, this closing of the nutrient cycle decreases dependence on synthetic fertilizer production and is more efficient when animal and crop production are combined locally.⁷⁶⁹ For more information on animal fertilizers, see the section on manure in 5.4 *Soil Amendments*.

Antimicrobials in Animal Agriculture

In the U.S., food animals are often exposed to antimicrobials to treat and prevent infectious disease or to promote growth. Many of these antimicrobials closely resemble, or are identical to, the drugs used by the human population.⁷⁷⁰ About 70 percent of all of the U.S. antimicrobials produced are fed to animals to help promote growth and treat disease.⁷⁷¹

The high volume and frequent use of antimicrobials in animal agriculture has greatly increased the development of drug resistant strains of disease, causing several outbreaks of heavily drug resistant diseases.⁷⁷² The National Research Council and Institute of Medicine found that there is a strong link between the use of antimicrobials in food animals and the development of bacterial resistance to these drugs and human diseases. Despite increased bacterial resistance, they found that the incidence of such diseases is very low.⁷⁷³ The World Health Organization has called for the reduced use of antimicrobials in animal agriculture, as a number of resistant diseases are able to pass to humans through the food chain, particularly strains of *Salmonella*, *Campylobacter*, *Enterococci*, and *E. coli*.⁷⁷⁴



10.2 Health Effects

Pesticides

All pesticides must be toxic or poisonous in order to kill the pests they are intended to control, for this same reason they are potentially hazardous to humans and animals as well as pests. Pesticide toxicity varies widely and is dependent upon a number of factors. According to the *Toxicity of Pesticides* the “most important factor is the dose-time relationship,” where the dose is the quantity of a substance that a surface, plant, or animal is exposed to and time is how often the exposure occurs.⁷⁷⁵

The interaction between the dose and time gives rise to two different types of toxicity: acute and chronic toxicity. Acute toxicity refers to how poisonous a pesticide is to a human, animal, or plant after a single short-term exposure. Acute toxicity is measured as the amount or concentration of a toxicant required to kill 50 percent of the target in a test population also known as lethal dose 50 (LD50).⁷⁷⁶ Given in units of milligrams per kilogram (mg of product per kg of test animal body weight), a higher LD50 value indicates a lower toxicity. Chronic toxicity is the delayed poisonous effect from exposure to a substance, generally through food, water, or air. Pesticides are rated according to their level of toxicity (acute and chronic), so while all pesticides carry a certain level of toxicity, the risk from toxicity to human and environmental health varies.⁷⁷⁷ An example is glyphosate, which according the USDA and Environmental Protection Agency (EPA) is environmentally less adverse than other herbicides (a lower environmental impact quotient compared to other herbicides currently used in crop production).⁷⁷⁸

Currently, more than 800 pesticide active ingredients from a wide range of commercial products are registered for use in agricultural operations.⁷⁷⁹ Under certain circumstances, residues from these active ingredients occur in treated crops at the time of harvest or can be transported into soil and water. Due to potential health risks for consumers, resulting from acute and/or chronic dietary exposure, maximum residue limits (MRLs) for many pesticides have been established.⁷⁸⁰

Pesticides can produce both short and long-term effects on human health. Long-term effects of pesticides can include disruption of the body’s reproductive, immune, endocrine, and nervous systems, as well as elevated cancer risks. A number of population-based studies have shown associations between certain types of pesticides and certain cancers.⁷⁸¹ Two of the most commonly applied herbicides in the U.S., atrazine and alachlor, are recognized as endocrine disruptors.⁷⁸²

Figure 39: Associations Between Various Classes of Pesticide and Various Forms of Cancer⁷⁸³

Class of pesticide	Cancer
Phenoxyacetic acid herbicides	Non-Hodgkin’s lymphoma, soft-tissue sarcoma, prostate
Organochlorine insecticides	Leukemia, non-Hodgkin’s lymphoma, soft-tissue sarcoma, pancreas, lung, breast
Organophosphate insecticides	Non-Hodgkin’s lymphoma, leukemia
Arsenical insecticides	Lung, skin
Triazine herbicides	Ovary



The majority of pesticides used in agricultural operations often affect non-target organisms and contaminate soil and water.⁷⁸⁴ In recent years, there have been increasing concerns regarding the potential risks to the general population from pesticide exposure through the food and water supply.

The overall impact of a pesticide on human health and the environment depends on several factors, including its behavior in the environment, its ecotoxicity, and the amounts applied. For human toxicity, estimates of pesticide residues show that food intake results in the highest toxic exposure, about 103 to 105 times higher than that induced by drinking water or inhalation.^{785, 786} Despite residues on food being the primary exposure route, there is a general lack of data in terms of the level of pesticide residue in food and potential effects.⁷⁸⁷

Pesticide residues in food are heavily influenced by the storage, handling, and processing that occur post-harvest of raw agricultural commodities, but prior to consumption of prepared foodstuffs by end consumers. An extensive literature review demonstrates that in most cases, processing leads to large reductions in residue levels in the prepared food, particularly through washing, peeling, and cooking operations.⁷⁸⁸

Genetically Engineered Crops

The health risk assessment of genetically engineered (GE) crops cultivated for food or feed is under debate throughout the world, but very little data have been published on mid- or long-term toxicological studies with mammals.^{789, 790} A study conducted by the Monsanto Company with transgenic corn MON863 (designed for human consumption), found no adverse health effects between rats fed the GE corn versus conventional, but regulatory reviewers in Europe heavily criticized the study's findings. The courts ordered an independent review of the same study data from Monsanto. The second study observed that after the consumption of MON863, rats showed slight but dose-related variations in growth patterns for both sexes, resulting in 3.3 percent decrease in weight for males and 3.7 percent increase for females. The study's authors hypothesized that this may not only be an indication of the dysfunction of several organs, but also a sex-dependent effect related to endocrine disruption and/or hormonal metabolism differences from the MON863 diet. The results of the study lead the authors to recommend that based on the data it cannot be concluded that GE corn MON863 is a safe product and that a new assessment and longer exposure of mammals to these diets is needed before concluding that MON863 is safe to eat.⁷⁹¹

In *Safety of Genetically Engineered Foods*, the National Institute of Science evaluated the likelihood for unintended health effects to occur as a result of various methods of genetic modification. The committee evaluated genetic engineering on a continuum with other forms of genetic alteration, presented in Figure 40.⁷⁹² Overall, the committee found that the process of "genetic engineering has not been shown to be inherently dangerous, but rather, evidence to date shows that any technique, including genetic engineering, carries the potential to result in unintended changes in the composition of the food."⁷⁹³

This continuum shows the relative likelihood of unintended genetic effects—any unintended effects, not necessarily those associated with health effects—associated with various methods of plant genetic modification. The gray tails in Figure 40 show the range of potential unintended changes while the black bars indicate the relative degree of genetic disruption for each method.



Figure 40: Relative Likelihood of Unintended Genetic Effects⁷⁹⁴
 (For definition of terms used in the below methods of genetic engineering please see Figure 41)

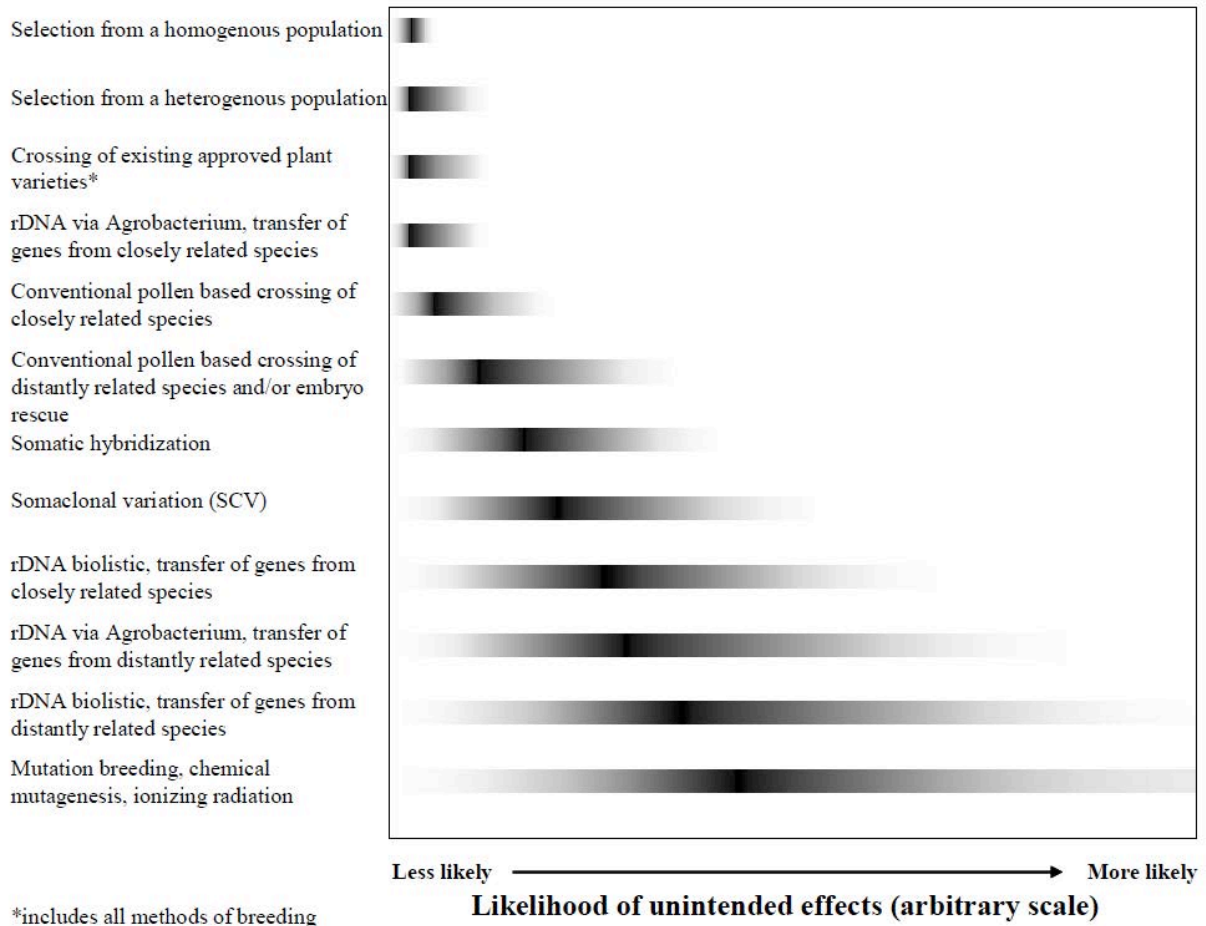

Food Allergies

Food allergies occur in approximately two to eight percent of the population with most food allergies associated with only eight foods or food groups, including milk, eggs, peanuts, tree nuts, fish, shellfish, soy, and wheat.^{795, 796, 797} From 1997 to 2007, food allergies increased 18 percent among children 18 years of age and younger, which represented a significant increase from previous rates.⁷⁹⁸ Allergenic foods can contain up to 20,000 proteins, but typically only 10 to 20 of these proteins may cause allergic reactions. The chances of being exposed to an allergenic food protein or developing a specific food allergy remains relatively low, despite increasing rates.^{799, 800, 801}

One of the major health concerns with genetically engineered food is its potential to increase allergies in the human population through the food chain.⁸⁰² The potential allergy risks from GE food crops to consumers can be placed into one of three categories. The first is when a gene is transferred from a source of known allergenic



potential into a food crop. The second category, which represents an intermediate risk, is the potential for altering or replacing the endogenous allergenicity (the insertion of new genetic material which can cause a change in the level of allergenic proteins normally found) of a GE crop, which would cause an increased concern for already allergic patients. The last category, which has received attention as of late, involves expression of new proteins that may become allergens in man but generally represents a relatively low risk to the consumer.⁸⁰³

Figure 41: Methods for Genetically Altering Plants⁸⁰⁴
(Adapted from the National Academy of Sciences)

Methods for Genetically Altering Plants

Genetic engineering is a subset of the many methods of genetically modifying plants and animals. Some of these methods are listed below.

Non-GE Methods (Non-targeted)

Simple Selection: Plants with desired traits are selected for continued propagation.

Crossing: Brushing pollen from one plant onto a sexually compatible plant to produce a hybrid with genes from both parents.

Embryo Rescue: Placing a plant that has naturally cross-pollinated into a tissue culture environment to enable its full development.

Mutagen Breeding: Exposing plants or seeds to mutagenic agents (e.g., ionizing radiation) or chemicals to induce random change in the DNA sequence; new plants are assessed for valuable traits.

GE Methods: (Targeted)

Microbial vectors: Takes advantage of a microbe's ability to transfer and stably integrate segments of DNA into a plant so that the plant then expresses those traits.

Electroporation: Plant cells growing in culture are stripped of their protective walls; DNA is then supplied to the medium and electric shock used to destabilize the cell membrane and allow DNA to enter.

When a gene is transferred from a source of known allergenic potential, the assessment of the allergenicity of the GM crop is relatively straightforward. Similarly, it is relatively easy to assess the effect of genetic engineering on endogenous allergens in crops with some evidence of allergenicity. There are several examples of this happening, such as the demonstration of the allergenicity of the Brazil nut when used to enhance the

nutritional quality of transgenic soybeans⁸⁰⁵ or the codfish allergy in potatoes that have been genetically engineered with cod protein genes to make the potatoes tolerate cold storage.⁸⁰⁶ In both of these cases, production of the GE foods was stopped and the product was not allowed to go to market.

It becomes increasingly difficult to assess the allergenicity of GE foods when the gene is transferred from a plant whose allergenic potential is unknown. As a result of this gene transfer or vector insertion, it is possible that a new allergen is developed or the expression level of a minor allergen is increased in the GE crop. Unfortunately, while there are good animal models for nutritional and toxicological testing, no satisfactory animal models have so far been developed for allergenicity testing.⁸⁰⁷ For the time being, only indirect methods are available for the assessment of the allergenic potential of GE foods derived from sources of unknown allergenicity.⁸⁰⁸ The World Health Organization and the Food and Agriculture Organization of the United Nations' report, *Evaluation of Allergenicity of Genetically Modified Foods*, identified the need for further development and validation of suitable animal models and procedures for the assessment of allergenicity of foods derived from biotechnology.⁸⁰⁹

A study looking at the transfer of a gene from a kidney bean to field peas, to make the peas resistant to bruchid storage beetles, demonstrated that the transgenic expression leads to the synthesis of a modified form of protein that altered antigenic properties and elicited an immune response from the tested mice. This means that the transgenic protein altered immune response in the mice, but did not necessarily demonstrate allergenicity. Based on these findings the authors concluded that the transgenic expression of non-native proteins in plants may lead to the synthesis of structural variants with altered immunogenicity.⁸¹⁰ This study caused a lot of media attention due to the potential for GE crops to pose an allergy risk, though a number of other studies have called into question the study's design.^{811, 812} Of concern is the model used to test for allergenicity, which has not been widely used or tested and thus may not prove to be as accurate as other methods.⁸¹³ Despite some questions about the accuracy of the study's design, the safety concerns raised by the study's authors were enough to halt further development of the transgenic variety and keep it from reaching the market.⁸¹⁴

In order to mitigate the three categories of potential allergy risk associated with GE crops, all genes introduced into food crops undergo a series of tests designed to determine if the biotech protein exhibits properties of known food allergens. The process for assessing potential allergenicity was first proposed by the United States Department of Agriculture (USDA) and later modified by the Food and Agriculture Organization and the World Health Organization. The process begins by examining the source of the gene. If it comes from a crop that contains a known allergen, both in vitro and in vivo diagnostic tests may be required, depending on whether or not a gene is to be introduced to a commodity crop. If the gene is not derived from a known allergen, the amino acid sequence is examined for homologies that would indicate the potential to bind immunoglobulin E. Furthermore, the amino acid sequence of all introduced genes, whether derived from a known allergen or not, are compared to amino acid sequences of conventional crops to determine the existence of other potential safety issues. Allergenicity is further evaluated by determining a protein's ability to withstand digestion by pepsin using simulated gastric fluid.⁸¹⁵

As a result of the risk assessment process, to date, no biotech proteins in foods have been documented to cause allergic reactions,^{816, 817, 818} though a number of studies have raised concerns of potential implications for allergic reactions. Despite several studies showing the potential for allergic reactions, or even specific cases of identified allergens, no commercially grown GE crop has been shown to cause allergic reactions owing to a transgenically introduced allergenic protein or a significant increase in the endogenous allergenicity of a crop.⁸¹⁹

At present, it is clear that if and when a protein gene is derived from a source with a history of allergenicity, there is a reasonable certainty that the GE crop will be allergenic. Unfortunately, many studies have highlighted that the use of a gene from something that is not allergenic will not guarantee that the GE crop will not possess allergenicity.^{820, 821, 822} In the absence of reliable methods for allergenicity testing, particularly the lack of good animal models, it is very difficult to completely assess if a GE crop may be allergenic or not.^{823, 824}

11. Local Economy

Summary

The agricultural market in Boulder County is strong overall. Between 2002 and 2007, agriculture in Boulder County and the State of Colorado saw an increase in market value of four and 34 percent respectively. During this same time period, Boulder County saw an increase in agricultural acreage of 28 percent, compared to two percent for the entire State. While some of these market gains were hampered by the recession, with a 19 percent decrease in agricultural net value for the State between 2008 and 2009, the market has remained relatively stable.

Small farms (\$10,000 to \$249,000 gross cash income) represent a significant market value in Boulder County, accounting for about 28 percent of output, or nearly \$9.8 million, a rate that is higher than the national average of 22 percent. Additionally, the County has added more small farms (less than 50 acres each) between 2002 and 2007 than any other size operation, though larger farms are still the dominant operation. As of 2007, about half a percent of productive acreage was devoted to organic production in Boulder County. Sales from organic products represented just under three percent of the total agricultural output in the County, which is much higher than the State average of less than one percent.

One of the greatest challenges faced by small farms in Boulder County is finding markets for their products. While hard numbers are hard to come by, a number of small-farm operations are participating in direct marketing of their products to local restaurants, farmers markets, and to a smaller extent farm shares or community supported agriculture. One of the largest challenges identified in the literature facing smaller farmers is being able to efficiently manage the logistics of direct marketing opportunities.

Agriculture in Boulder County is increasingly coming under greater market competition for water and land resources as the population in the Front Range continues to expand. The increase in demand for municipal, industrial, and self-supplied industrial water is expected to be greater in the South Platte River Basin than anywhere else in Colorado. The value of agricultural land versus other development options can be difficult to quantify, however, studies conducted by Colorado State University demonstrated that converting agricultural land to residential use in Boulder County would actually cost the County more to provide community services than would be returned per every dollar of tax revenue generated.

11.1 Income

The number of farms in the state of Colorado has remained relatively constant in recent years. From 2002 to 2007, Colorado's agricultural sector experienced a 34 percent increase in market value (to \$6,061,134,000), 33 percent of which came from crop production and the remaining 67 percent from livestock production.⁸²⁵ However, between 2008 and 2009 the agricultural sector as a whole saw a six percent decrease in output (to \$6,639,721,000) and a 19 percent decrease in net value added (to \$1,632,283,000). Farm operators have also seen a 37 percent decrease in net income, down from \$1,178,935,000 in 2008 to \$744,918,000 in 2009.⁸²⁶

Boulder County saw a much smaller, four percent, increase in market value between 2002 and 2007. In contrast to the State, a substantial percentage of agricultural market value, 76 percent, was generated from crop production, while only 24 percent came from livestock production. Boulder County experienced a 28 percent increase in agricultural acreage from 2002 to 2007 compared to only a two percent increase for the entire state. This increase can be partially attributed to an increase in the number and diversity of farms responding to the 2007 Census in Boulder County. In these same years, the largest increases in production in Boulder County included haylage (1,107.3 percent), carrots (500 percent), angora goats (307.1 percent), and grapes (300 percent). The largest decreases included the number of pigs and hogs sold (69.2 percent), cantaloupe (66.7 percent), the value of pigs and hogs sold (64.6 percent), and the number of milk goats (51.6 percent).⁸²⁷

11.2 Farm Size

The size of a farm, as defined by the United States Department of Agriculture (USDA) Economic Research Service, is determined by examining a farm's gross cash income: the sum of commodity sales revenue, government payments, and other on-farm income. Though the number of farms nation wide has remained stable at two million between 1991 and 2007, there has been a noticeable shift in size distribution from small, diversified farms toward large, specialized farms. In Boulder County, the average farm size has increased by 39 acres from 2002 to 2007. The County has seen a seven percent increase in the number of small farms, less than 50 acres, which can partially be attributed to an increase in the number of farms responding to the census.⁸²⁹ This suggests that the larger farms in Boulder County are continuing to get bigger, while at the same time smaller farms are increasing in number. This shift from small- to large-scale production is attributed to three main factors: profitability, advancements in technology, and increasing age of farm operators.⁸³⁰

Figure 42: Farm Size⁸²⁸

Non-commercial: gross cash income (GCI) of less than \$10,000

Small commercial: GCI of \$10,000-\$249,000

Large commercial: GCI of \$250,000-\$999,000

Very large commercial: GCI \$1 million

The profitability of large-scale production is due in part to economies of scale: as the size of the operation increases, the average cost of production per unit decreases. This principle is reflected in the percentage of U.S. farms operating on a negative profit. In both 1991 and 2007, almost 60 percent of small commercial farms were running on a negative profit. The percent of large and very large farms that operated on a negative profit dropped to 23 percent and 15 percent respectively by 2007. While the percentage of non-commercial farms reporting negative profits jumped from 66 to 75 percent between 1991 and 2007, profit is not typically a primary motive for running a non-commercial farm, and thus not a significant concern. Rather, non-commercial operators tend to be more interested in the rural lifestyle and rely heavily on off-farm income to generate a living.⁸³¹

Advances in technology also lend to the profitability of large-scale production. In addition to improvements in mechanical technology and equipment, advances have also been made in disease control, breeding and genetics, and animal housing. Such advances make large-scale operations more feasible than they otherwise would be by helping increase production through reduced impacts from disease and natural events and improved efficiency of production.⁸³²

Small farms also have a higher percentage of operators 65 and older. In 2007, 32 percent of small farm operators were age 65 or older, compared to 27 percent on non-commercial farms, 17 percent on large farms, and 15 percent on very large farms. In 2007, the average age of farmers in Boulder County was 59.4 years of age, higher than both the State of Colorado and national average.⁸³³ This increase, which is double the national average, reflects a changing pattern of employment with principal operators continuing to work well past standard retirement ages as well as a drop in interest from younger farmers who are increasingly pursuing careers outside of agriculture.⁸³⁴ More information can be found in 9.2 Demographics

Despite the declining numbers of small commercial farms, in 2007, small farm production accounted for 22 percent of total U.S. agricultural output, or \$65 billion. In Boulder County, small farms account for 28 percent of output, or nearly \$9.8 million.⁸³⁵ The percent contribution to total U.S. agricultural output of several commodities from small commercial farms is shown in Figure 43.⁸³⁶



Figure 43: Commodities Where Small Farms Have a Strong Market Presence⁸³⁷

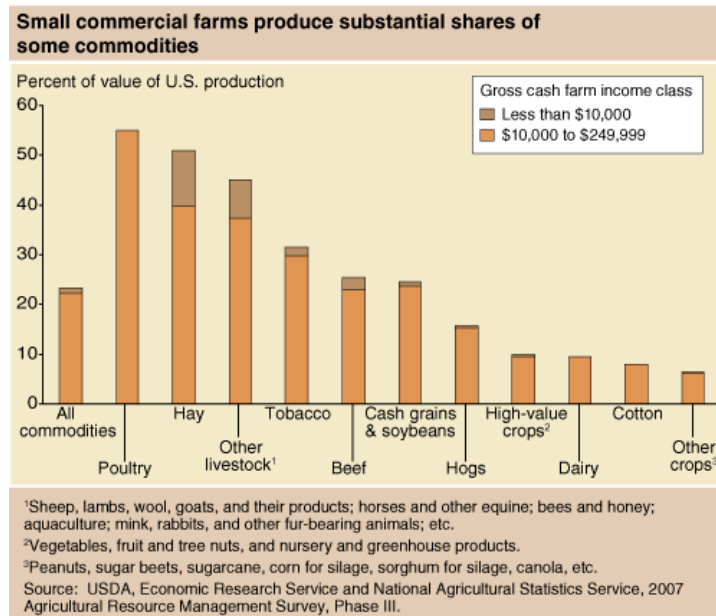

The high production of low-labor commodities on small farms, such as poultry, hay, and beef (Figure 43), rather than more time- and labor-intensive commodities such as fruits, vegetables, and dairy, reflects that the farm itself typically is not the primary source of income and operators are often highly reliant on off-farm income to supplement their operations.⁸³⁸ Though small farms are declining in numbers, they are expected to continue to be present due to their reliance on off-farm income and because some are profitable, 25 percent are operating with a profit of 20 percent or more.⁸³⁹

11.3 Infrastructure

Research shows that local agriculture infrastructure is limited in the Boulder County Region. Local sources of agriculture infrastructure, including input suppliers, processing plants, equipment repair companies, and storage facilities, help to reduce transportation and logistical costs for farmers and can help steady the supply of local produce to consumers.

Farm equipment represents a significant investment for farmers. In Boulder County, the market value of all machinery and equipment grew from \$33,698,000 in 2002 to \$49,705,000 in 2007. Expenditures on supplies, repairs, and maintenance of this equipment made up seven percent (\$2,296,000) of total production expenses in 2002 and eight percent (\$3,181,000) in 2007.⁸⁴⁰ While farm equipment supply and repair companies exist in the state of Colorado, it is difficult to determine how many there are, their proximity to Boulder County, and prices charged for various services.

As of 2007, 34 farms have grain storage capacity in Boulder County that can hold a combined total of 298,800 bushels. Average capacity for Boulder County is about 8,788 bushels per farm, which is quite low compared to the statewide average of 38,088 bushels per farm. Most farms in Boulder County (19) store the grain for crop production, while the remaining 15 farms use it for animal production.⁸⁴¹ Data on storage for other crops (e.g. potatoes, onions, and beans) was limited.

11.4 Competing Resource Use

Due to limited precipitation in the high plains of Colorado, competition for water use is a significant issue. The increase in demand for municipal and industrial (M&I) and self-supplied industrial (SSI) water demand is expected to be greater in the South Platte River Basin than anywhere else in Colorado.⁸⁴² The population along the Front Range is expected to increase by two million by 2030, requiring an additional 400,000 acre-ft. of water⁸⁴³ or a 53 percent increase in current water demand.⁸⁴⁴ To meet this increased demand, the Statewide Water Supply Initiative states that irrigated acreage will experience a significant decrease (29-49 percent), currently projected as a reduction of 133,000-26,000 currently irrigated acres.⁸⁴⁵

Researchers at Colorado State University performed an analysis looking at the overall impact that such a reduction would have on the economy of the eastern portion of the South Platte Basin, not including Boulder County. The study focused on the eastern portion of the basin because of the higher percentage of irrigated acreage. Data was based on the assumption that the irrigated land would be converted to fallow land because dryland cropping is economically unfavorable. It is estimated that each acre of irrigated land in the South Platte Basin generates \$690. Assuming a loss of 159,500 irrigated acres, the basin would be expected to lose \$110 million.⁸⁴⁶

Of the four river basins in the study, the South Platte Basin is expected to suffer the greatest economic impact for two reasons: (1) the South Platte Basin is projected to lose the most irrigated land, and (2) it has the largest output multiplier of 1.78 (i.e. for every dollar of agricultural output lost, there will be a greater ripple effect on the regional economy as a whole, most likely because farmers in the South Platte Basin rely more heavily on local inputs).⁸⁴⁷

At the same time, the South Platte Basin is also expected to be in the best condition for coping with the economic impacts of reduced irrigation. Because the South Platte Basin has the highest population of the river basins in the analysis, the per capita impact is the smallest (a loss of \$97 per person), despite the highest *total* economic impact. The South Platte Basin is also the most economically diverse, indicating a greater chance that farm operators will be able to find employment in other sectors as productive agricultural land is lost.⁸⁴⁸

Water Transfers

When trends were compared in the South Platte Basin from 1979 to 1995, it was found that the very nature of the water market in the basin has helped increase its resiliency in its ability to meet growing municipal demand.⁸⁴⁹ Water in the South Platte Basin comes from native supplies, which are managed through the sale and lease of water rights, and supplemental supplies from the western Rockies, which are managed through the Northern Colorado Water Conservancy District (NCWCD). The NCWCD lacks a water court review process, making the water transfer process quicker and less costly than other districts.⁸⁵⁰ The majority of the water transfers in the South Platte Basin are agriculture-agriculture and stay within the basin. Agriculture-urban transfers inevitably lead to a loss of productive land and economic output as once-irrigated land is fallowed and farm dependent businesses are negatively affected by the loss of agricultural outputs. Agriculture-agriculture water transfers do not have the same negative side

effects since the water use remains the same. Due to the above factors, the South Platte Basin is much more resilient in meeting increased municipal demand.⁸⁵¹

In addition to M&I and SSI water demands, water is also necessary for habitat restoration. For example, the Endangered Species Act mandated that approximately 417 thousand additional acre-ft. of water flow through a 56-mile stretch along the eastern portion of the Central Platte River, which is home to a number of endangered and threatened species, in order to maintain the habitat.⁸⁵² In the past, economists have determined that the most economically viable solution is reallocation of water from “low-value” to “high-value” uses; in this case, the transfer of water from the irrigation of low-value crops to habitat restoration.⁸⁵³

Water Leasing

The Colorado Water Conservation Board noted that:⁸⁵⁴

“as municipal water demands continue to increase, irrigators will continue to see an increased interest in their water rights from cities. Irrigators may begin to view their water rights as another “crop” and cities may begin to view the cornfields as reservoirs.”

This shift is expected to increase the consideration of alternative methods to permanent transfers of water rights for municipal and industrial use. One option for lessening the economic impact of reduced irrigated acreage is to establish a leasing market for water rights. The permanent sale of water rights from agricultural to non-agricultural use typically results in the conversion of irrigated land to fallow land due to the potentially unprofitable nature of dryland cropping, and ultimately, a loss of production and economic output. Leasing water, however, enables farmers to retain their water rights, allowing them to continue farming, either on a rotational basis or on a continuous basis using less water for irrigation.⁸⁵⁵ Water leasing, as with other water transfers, is constrained by a number of physical, institutional, and legal mechanisms, since not all agricultural water rights can be moved from the land it irrigates due to decree or authorizing legislation.⁸⁵⁶

Water leasing is not currently common in the state of Colorado, but has been employed successfully in the City of Aurora. In 2003, Aurora initiated a two-year pilot program where temporary water leasing was negotiated with 160 farmers allowing the City consumptive use of the water. The program helped provide drought protection for the City of Aurora and income to farmers with no permanent dry-up or conversion of farmland.⁸⁵⁷

A survey sent to water rights holders in the South Platte Basin to determine their willingness to lease their rights in order to meet increasing M&I water demand was compiled in 2008. The study found that only seven percent of respondents intend to sell their water rights within the next five years. Furthermore, 70 percent believe that leasing is more beneficial to rural communities than the sale of rights and 61 percent would be willing to lease, rather than sell, their rights.⁸⁵⁸ If a leasing market were to be established however, 60 percent of farmers showed a clear preference for fallowing their land for a period of time (with sufficient compensation) whereas only 32 percent preferred reducing output through a reduction in irrigation. When asked about compensation, about 30 percent of respondents required \$400/acre to fallow their land for one year.⁸⁵⁹



Based on the above findings, and the fact that one-third of respondents were willing to lease all of their water, the surveyors concluded that there is enough willingness to make a leasing market economically viable. What is unclear at this point is the municipal water suppliers' willingness to pay for leases and if so, whether the price they are willing to pay meets the desires of the rights holders.⁸⁶⁰

Land

Competition for land use has economic implications for both the tax base and residential property values, however, decisions regarding land use are largely dependent on how the use contributes to the tax base. The American Farmland Trust (AFT) has performed numerous studies on the economic impacts of rural land development and has determined that in Colorado, residential development requires on average \$1.15 in community services for every \$1 of tax revenue it contributes. Farm and forest land requires \$0.35 in services for every \$1 of outgoing tax revenue. Finally, commercial and industrial uses demand the least services (\$0.27 for every \$1) relative to their contribution.⁸⁶¹

The AFT's methodology has received significant criticism, however, for being inadequate and biased. Researchers at Colorado State University performed their own analysis in an attempt to address some of the shortcomings of the AFT's methodology. They calculated the ratio of community service cost to each dollar of generated revenue for each county in Colorado. Their analysis showed that "all Colorado counties, except Elbert County (\$0.536:1), show a negative net fiscal impact of dispersed rural residential development and the majority lie within a range consistent with AFT findings...however, there is substantial variation across counties." Their results also indicate that the character and type of development need to be considered, rather than aggregating land-use type, in order to determine whether or not it will result in a net fiscal loss. For Boulder County, the calculated cost ratio of providing community services per every dollar of tax revenue generated by converting 35 acres of agricultural land to one county average household is 1.108, demonstrating that converting agricultural land to residential use ends up costing the county.⁸⁶²

11.5 Direct Marketing

One of the challenges faced by small farms is finding markets for their products. Since wholesalers offer low prices and shipping products is costly, wholesale is not favorable for small-farm operations. Rather, supporting direct marketing schemes is important for sustaining these operations. However, managing the logistics of direct marketing schemes has its own set of challenges.

Challenges associated with direct marketing include:^{863, 864}

- Less-than-desired sales volume for customers
- The seasonality of crops
- The lack of grower flexibility in meeting quick changes in customer demand
- Potential inability of grower to meet volume demand
- Competitive pricing offered by wholesalers
- Vendor bid systems/contracts that exclude local producers
- Requirements of customers to obtain food through government programs
- Insurance requirements for vendors
- Lack of discretionary budgets for customers
- Lack of discretion to pay higher prices for higher quality food
- Associated with increased hassle (more phone calls, coordinating pick up, inconsistent supplies, etc.)

Overall, larger restaurants and institutions are less likely to purchase local food than smaller ones. Whether restaurants and institutions do or do not buy local food, they are highly concerned with its freshness and dependability. Restaurants that buy locally are significantly more likely to do so in order to support the local economy and are typically interested in pesticide-free food.⁸⁶⁵ While price is a concern when purchasing food, it is not one of the primary reasons for customers deciding whether or not to purchase locally.⁸⁶⁶ Quality is currently not a significant factor in buyers' decisions generally due to a lack of awareness about the potentially higher quality of local produce. If local farmers are more assertive about their higher quality of products and services, they may appeal more to local buyers.⁸⁶⁷

Market for Organic Products

Organic farming, as defined by USDA standards set in 1990, has grown in the past decade. Nationwide, organic acreage increased 4.5 times between 1992 and 2007, from 935,450 to 4,289,957 acres. In 2007, 0.53 percent of Boulder County acreage was devoted to organic production, including land in the process of being converted, which is slightly higher than the state of Colorado at 0.33 percent.⁸⁶⁸ These numbers are relatively consistent with U.S. percentages: 0.7 percent of U.S. cropland and 0.5 percent of pasture were certified organic in 2008.⁸⁶⁹

Such low percentages are attributed to a number of tradeoffs. Organic agriculture is associated with lower input costs, conservation of nonrenewable resources, capturing high-value markets, and boosting farm income. At the same time, there are a number of obstacles, including high managerial costs, risks of shifting production methods, limited awareness of organic farming systems, lack of marketing and infrastructure, and an inability to capture marketing economies.⁸⁷⁰



In 2007, organic product sales represented 2.83 percent of the total agricultural output in Boulder County, higher than the state of Colorado's average of only 0.83 percent.⁸⁷¹ Unfortunately, the 2002 Census of Agriculture does not include data on organic produce, making it difficult to determine market trends. Though the percentages of total agricultural output from organic produce seems low, Colorado is among the top organic producing states (Figure 44).

Figure 44: 2007 U.S. Organic Produce Output

Note: Data for Nevada was not available

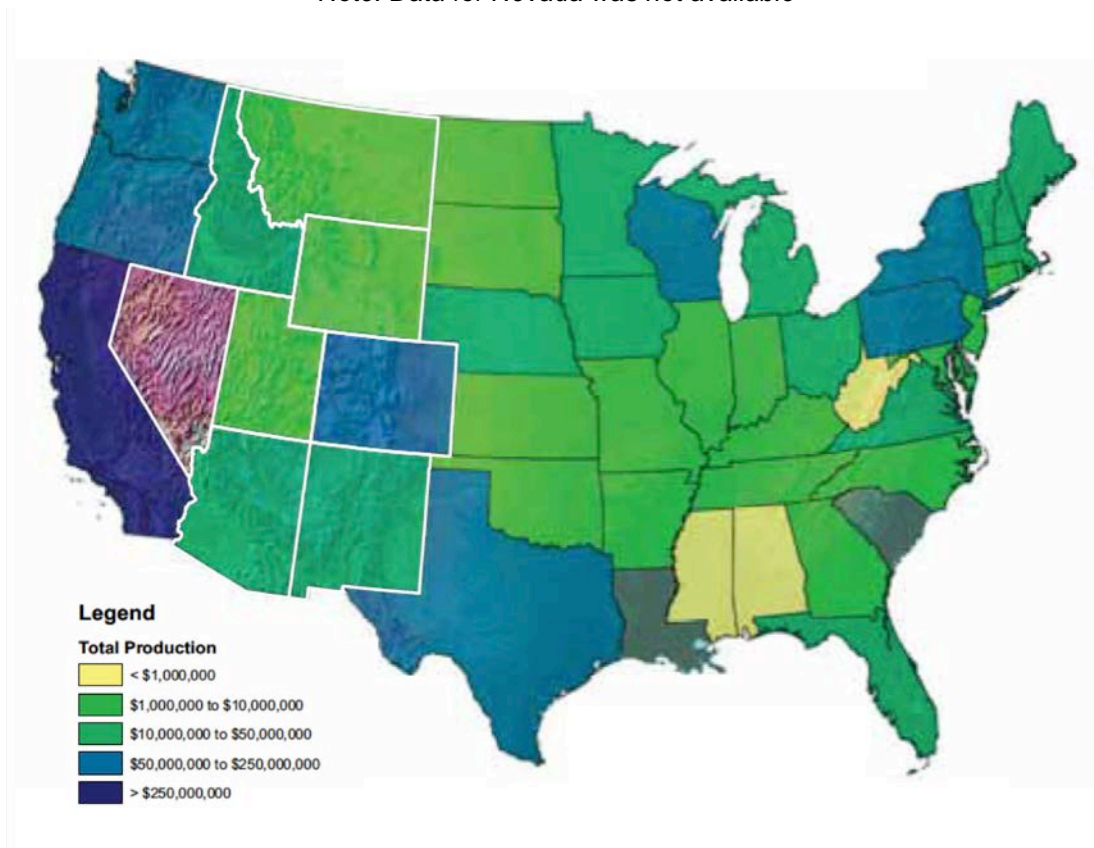

Data comparing profitability of organic farming versus conventional farming is limited. However, both organic and conventional farmers spend the same amount of time (six percent of their days) working off of their farms. Such findings suggest that supplemental incomes are no more important to organic farmers than conventional farmers, likely due to the higher prices that organic farmers receive for their commodities.⁸⁷²

Glossary of Terms

Agricultural biotechnology: A collection of scientific techniques, including genetic engineering, that are used to create, improve, or modify plants and animals and microorganisms. Using conventional techniques, such as selective breeding, scientists have been working to improve plants and animals for human benefit for hundreds of years.⁸⁷³

Aerodynamic Roughness Length: The height at which wind speed equals zero and is approximately one-tenth the height of the surface. The surface properties of an area have implications on wind patterns: for example, the roughness length of a forest is much greater than that of the plains.⁸⁷⁴

Agroecology: The design, development, and management of sustainable agroecosystems based on the application of ecological principles while considering existing social, cultural, and economic factors of farming communities.⁸⁷⁵

Agroforestry: Agroforestry intentionally combines agriculture and forestry to create integrated and sustainable land-use systems. Agroforestry takes advantage of the interactive benefits from combining trees and shrubs with crops and/or livestock.⁸⁷⁶

Albedo: The reflective property of a surface, which is expressed as a ratio of the amount of radiation reflected to the amount of radiation that falls on the surface, and is thus a percentage ranging from 0-100. The earth and the atmosphere respectively reflect four and 26 percent of the sun's radiation annually.⁸⁷⁷

Bio-dynamic (agricultural practices): Method includes certain herbal preparations that guide the decomposition processes in manures and compost.⁸⁷⁸

Bio-char: A charcoal rich in nutrients and organic carbon that is produced from partially burning biomass. The application of bio-char improves soil fertility by adding and retaining soil nutrients.

Bioconcentration: The movement of a chemical from the surrounding medium into an organism such that higher concentrations occur within the organism.⁸⁷⁹

Biomagnification: Sequence of processes in an ecosystem by which higher concentrations are attained in organisms at higher trophic levels (at higher levels in the food web); at its simplest, a process leading to a higher concentration of a substance in an organism than in its food.⁸⁸⁰

Biorational pesticides: Very selective pesticides, targeting just the pest, that usually do not persist in the environment, are much safer to handle and apply when compared to most chemical pesticides, and tend to preserve beneficial organisms.⁸⁸¹

Biosolids: The nutrient-rich organic materials resulting from the treatment of sewage sludge. When treated and processed, sewage sludge becomes biosolids, which can be safely recycled and applied as fertilizer to sustainably improve and maintain productive soils and stimulate plant growth.⁸⁸²



Border irrigation: An irrigation method used on nearly level fields that are planted close to growing crops. In border irrigation water soaks into the soil as it advances down narrow strips between the ridges. Uniform grades are necessary to ensure an even distribution of water and to prevent ponding.⁸⁸³

Bt crops: Crops that are genetically engineered to carry the gene from the soil bacterium *Bacillus thuringiensis*. The bacteria produce a protein that is toxic when ingested by certain Lepidopteran insects. Crops containing the Bt gene are able to produce this toxin, thereby providing protection throughout the entire plant.⁸⁸⁴

Bt cotton: Cotton that is genetically engineered to control tobacco budworms, bollworms, and pink bollworms.⁸⁸⁵

Bt Corn: Corn that is genetically engineered to provide protection against the European corn borer.⁸⁸⁶

Cavitation: is the implosion of bubbles of air and water vapor and makes a very distinct noise like gravel in the pump. The implosion of numerous bubbles will eat away at an impeller and it eventually will be filled with holes.⁸⁸⁷

Controlled flooding: An irrigation method used on close-growing crops. Water is flooded down the slope between closely spaced field ditches.⁸⁸⁸

Conventional Agriculture: An industrialized agricultural system characterized by mechanization, monocultures, and the use of synthetic inputs such as chemical fertilizers and pesticides, with an emphasis on maximizing productivity and profitability. Industrialized agriculture has become “conventional” only within the last 60 or so years (since World War II).⁸⁸⁹

Corrugation irrigation: A surface irrigation method where small channels or corrugations are used to guide water across a field.⁸⁹⁰ This method is used on fields that do not have uniform grades.⁸⁹¹

Cover crop: A cover crop is any crop grown to provide soil cover, regardless of whether it is later incorporated. Cover crops are grown primarily to prevent soil erosion by wind and water.⁸⁹²

Cross-pollinate: Cross-pollination occurs between two plants via wind, insects, or water.⁸⁹³

Desertification: The expansion of dry lands due to poor agricultural practices (overgrazing, degradation of soil fertility and structure, etc.), improper soil moisture management, salinization and erosion, forest removal, and climate change.⁸⁹⁴

DL-methionine: A concentrated form of methionine, one of the important building blocks of protein needed by birds for growth, feathering and egg production. Because animal protein by-products cannot be used and organic soybean meal is very expensive, most organic poultry diets use some purified methionine. All of the diets presented in this factsheet contain DL Methionine; failure to add it to the diets will result in poor production, uneven flocks, and in severe cases, cannibalism.⁸⁹⁵



Ecoagriculture: A landscape approach to natural resources management that seeks to sustain agricultural production, conserve biodiversity and ecosystem services, and support local livelihoods.⁸⁹⁶

Endogenous allergenicity (also endogenous allergy): Working definition: Endogenous allergenicity is the allergenic proteins that naturally occur in specific food, for example, Ara h 1 and Ara h 2 in peanuts. Occasionally, a safety assessment includes some consideration of the effect of the genetic engineering levels of endogenous allergens in the host organism. Under most circumstances, alteration in the number of levels of endogenous allergens would not be expected. For example, both GE and conventional soybeans should be equivalently allergenic to soy-allergic consumers. If changes occurred in the levels of endogenous allergens, that would be properly characterized as unanticipated.⁸⁹⁷

The primary allergy risks to consumers from GM crops may be placed into one of three categories. The second category, which represents an intermediate risk, is the potential for altering or replacing the endogenous allergenicity of a GE crop, which would cause an increased concern for already allergic patients. However, several studies have explored this possibility and found no difference in the allergenic potential of GE foods when compared directly with their non-GE counterparts.⁸⁹⁸

Eutrophication: Process by which bodies of water become enriched in dissolved nutrients, e.g. phosphates, nitrates, nitrogenous compounds. The nutrients deplete the dissolved oxygen of the water by stimulating the growth of algae and other aquatic plant life.⁸⁹⁹

Evapotranspiration: The water lost to the atmosphere by two processes—evaporation and transpiration (see def.)⁹⁰⁰

Fallow fields: Cropland left idle in order to restore productivity, mainly through accumulation of water, nutrients, or both. The soil ordinarily is tilled for at least one growing season to control weeds and to aid in the decomposition of plant residues.⁹⁰¹

Furrow irrigation: is used with row crops. Water is taken from ditches by siphon tubes, gated pipes, or cuts in the ditchbank, and is applied in the furrows between the rows of plants. On sloping soils the use of contour furrows helps to control erosion by carrying water across the slope. On nearly level soils the furrows are straight.⁹⁰²

Genetic engineering (GE): A technique used to alter or move genetic material (genes) of living cells.⁹⁰³ Techniques include altering the DNA, substituting genetic material by means of a virus, transplanting whole nuclei, transplanting cell hybrids, etc.⁹⁰⁴

Glyphosate: A broad-spectrum, non-selective systemic herbicide that can be used on essentially all annual and perennial plants including grasses, sedges, broad-leaved weeds, and woody plants. It can be used on non-cropland and among a great variety of crops.⁹⁰⁵ It is the main ingredient in Roundup.

Green Chop: Forages cut at younger stage of maturity and fed wet directly to livestock.⁹⁰⁶



Green manure: "Green manuring" involves the soil incorporation of any field or forage crop while green or soon after flowering, for the purpose of soil improvement.⁹⁰⁷

Humus: Complex organic compounds that remain after many organisms have used and transformed the original material. Humus is not readily decomposed because it is either physically protected inside of aggregates or chemically too complex to be used by most organisms. Humus is important in binding tiny soil aggregates, and improves water and nutrient holding capacity.⁹⁰⁸

H7-1 sugar beet: Roundup Ready® sugar beet H7-1 plants (hereafter also referred to as H7-1) are genetically modified to express tolerance to glyphosate-based Roundup® herbicides, allowing their use for weed control in the crop not just in pre-emergence, but also throughout the growing season.⁹⁰⁹

Indirect Energy Use: The energy embedded in the goods and services purchased, but not directly consumed by the end-user.⁹¹⁰

Lifecycle Assessment (LCA): A technique to assess the environmental aspects and potential impacts associated with a product, process, or service, by: compiling an inventory of relevant energy and material inputs and environmental releases; evaluating the potential environmental impacts associated with identified inputs and releases; interpreting the results to help make a more informed decision.⁹¹¹

Living mulch: An extension of cover crops used to decrease soil erosion, suppress weeds, improve soil structure and nutrient cycling, and in the case of legumes, supply nitrogen to a grain crop. Unlike cover crops that are killed before planting the grain crop, living mulches co-exist with the crops during the growing season and continue to grow after the crop is harvested.⁹¹²

Low-input agriculture: A process that seeks to minimize the use of production inputs (i.e. off-farm resources), such as purchased fertilizers and pesticides, and to optimize the management and use of internal production inputs (i.e. on-farm resources) wherever and whenever feasible and practicable in order to lower production costs, avoid pollution of surface and groundwater, reduce a farmer's overall risk, reduce pesticide residues in food, and increase both short- and long-term farm profitability.⁹¹³

Monoculture (Monocropping): The growing of a single crop species on a field year after year. Contrast crop rotation and mixed cropping.⁹¹⁴

National Organic Program: Develops, implements, and administers national production, handling, and labeling standards. Responds to site-specific conditions by integrating cultural, biological and mechanical practices that foster cycling of resources, promote ecological balance, and conserve biodiversity.⁹¹⁵

Natural farming: A farming method that involves no tillage, no fertilizer, no pesticides, no weeding, no pruning, and minimal labor through careful timing of seeding and careful combinations of plants.⁹¹⁶

Net irrigation: The net amount of water that must be applied by irrigation to supplement stored soil water and precipitation to supply the water required for the full yield of an irrigated crop.⁹¹⁷



Neutral soil: A slight difference in soil qualities between the topsoil and subsurface soil, causing it to erode initially but then stabilize.⁹¹⁸

Non-point Source (NPS) pollution: Pollution sources that are diffuse and do not have a single point of origin, such as agriculture, forestry, and urban runoff.⁹¹⁹

Open pollinated: Open-pollinated vegetable varieties reproduce themselves in one of two ways: cross-pollination (see def.) or self-pollination (see def.).⁹²⁰

Organic agriculture: A production system, which avoids or largely excludes the use of synthetically compounded fertilizers, pesticides, growth regulators, and livestock feed additives.⁹²¹

Percolation: Percolation is the movement of water through the soil, and its layers, by gravity and capillary forces.⁹²²

Permaculture: The goal of permaculture is to produce an efficient, low-maintenance integration of plants, animals, people and structure. Strong emphasis is placed on design, the location of each element in a landscape, and the evolution of landscape over time.⁹²³

Permeability: The ability of water to flow through a soil.⁹²⁴

Point source pollution: Sources of pollution that originate from a single point, such as a discharge pipe or ditch.⁹²⁵

Polyculture (Polycropping): Growing two or more crops together.⁹²⁶

Potash: A mineral that is used primarily as an agricultural fertilizer (plant nutrient) because it is a source of soluble potassium.⁹²⁷

Precision agriculture: Precision agriculture is the practice of using remote sensing, soil sampling, and information management tools to optimize agriculture production.⁹²⁸

Progeny: A descendant or offspring as in a child, plant, or animal.⁹²⁹

Regenerative agriculture: see 'Sustainable Agriculture.'

Salinization: The accumulation of salts. Salinization occurs in warm and dry locations where soluble salts precipitate from water and accumulate in the soil. Saline soils are common in desert and steppe climate.⁹³⁰

Self-pollinate: Self-pollination occurs between two plants via the male and female parts contained within the same flower or separate flowers on the same plant.⁹³¹

Site-Specific Management (SSM): A practice that is being used to control and document traditional inputs in crop production such as fertilizer, seed, and crop chemicals.⁹³²



Sprinkler irrigation: An irrigation method that is used when slopes are steep or uneven. Sprinklers are an advantage when establishing pasture crops and in the preemergence irrigation of certain crops. With sprinkler irrigation, water losses resulting from evaporation may be higher than with other methods of irrigation and wind drift may cause uneven water application.⁹³³

Stecklings: Young sugar beet plants grown in seedbeds in summer, to be transplanted in the autumn or following spring.⁹³⁴

Strip cropping: The growing of crops in a systematic arrangement of strips or bands which serve as vegetative barriers to wind and water erosion. The strips or bands may run perpendicular to the slope of the land or to the direction of prevailing winds.⁹³⁵

Stubble mulch: Stubble or other crop residues left on the soil, or partly worked into the soil, to provide protection from wind and water erosion after harvest, during preparation of a seedbed for the next crop, and during the early growing period of the new crop.⁹³⁶

Susceptible soil: The subsurface soil below a good layer of topsoil is poor in quality, causing erosion to be much more likely, the soil is considered to be susceptible soil.⁹³⁷

Sustainable agriculture: A variety of definitions exist dealing with the philosophy and or practice of sustainable agriculture. These definitions generally support the concepts of environmental, economic, and social sustainability.⁹³⁸

The United States Department of Agriculture defines sustainable agriculture as “Use for the practice of agriculture, which supports sustained economic profitability, sustained quality, and well-being of the environment, efficient use of natural resources, and the overall quality and availability of food and fiber for mankind.”⁹³⁹

According to the Food, Agriculture, Conservation, and Trade Act of 1990, “the term sustainable agriculture means an integrated system of plant and animal production practices having a site-specific application that will, over the long term.”⁹⁴⁰

- Satisfy human food and fiber needs
- Enhance environmental quality and the natural resource base upon which the agricultural economy depends
- Make the most efficient use of nonrenewable resources and on-farm resources and integrate, where appropriate, natural biological cycles and controls
- Sustain the economic viability of farm operations
- Enhance the quality of life for farmers and society as a whole

Currently, there is no single standard for sustainable agriculture, although several organizations are moving towards this goal. The Scientific Certification Systems (SCS) and the Leonardo Academy (an American National Standards Institute accredited standard developer) are working together to standardize sustainable agriculture. The SCS embarked upon an effort to develop the strongest possible sustainable agricultural guidelines for the North American market — the SCS Sustainable Agriculture Practice Standard. In addition, SCS and the Leonardo Academy launched an initiative to develop a voluntary national, multi-stakeholder, consensus-based standard for sustainable agriculture.⁹⁴¹ “The purpose of the Standard is to establish a comprehensive framework and common set of environmental, social, and quality requirements by which to



demonstrate that an agricultural product has been produced and handled in a sustainable manner, from soil preparation and seed planting through production, harvest, post-harvest handling, and distribution for sale.⁹⁴² This proposed standard would be voluntary and would not replace the legal or regulatory requirements of any country in which agricultural products are produced, handled, or sold. The SCS recognizes eight key elements of sustainability, which include:⁹⁴³

- Sustainable Crop Production
- Ecosystem Management and Protection
- Resource Conservation and Energy Efficiency
- Integrated Waste Management
- Fair Labor Practices
- Community Benefits
- Product Quality
- Product Safety and Purity

Teratogenicity: Potential to cause or the production of structural malformations or defects in offspring.⁹⁴⁴

Tilth: The physical condition of soil as related to its ease of tillage, fitness of seedbed, and impedance to seedling emergence and root penetration.⁹⁴⁵

Transgenic crops: Crops that result from the insertion of genetic material from another organism so that the plant will exhibit a desired trait. Recombinant DNA techniques (DNA formed by combining segments of DNA from different organisms) are usually used to develop transgenic plants.

Transpiration: Transpiration is the biological process that occurs mostly in the day. Plants transpire to move nutrients to the upper portion of the plants and to cool the leaves exposed to the sun.⁹⁴⁶

Turbidity: A measure of the cloudiness of water – the cloudier the water, the greater the turbidity. Turbidity in water is caused by suspended matter, such as clay, silt, and organic matter that interfere with the passage of light through the water.⁹⁴⁷

Variable rate application (VRA): Allows a prescribed rate of fertilizer or lime to be applied to each location within a field, based on soil test results.⁹⁴⁸

Vermicompost: Composting with earthworms. Can contain worm castings, bedding materials, and organic wastes at various stages of decomposition. It can also contain worms at various stages of development and other microorganisms associated with the composting processing.⁹⁴⁹

Vermiculite: A mineral that is used in horticulture and mixed with soil to create a more porous, absorbent soil.⁹⁵⁰

Windrow: organic waste is formed into rows of long piles of compost called windrows that are aerated by turning the pile periodically by either manual or mechanical means. The ideal pile height, which is between 4 and 8 feet, allows for a pile large enough to generate sufficient heat and maintain temperatures, yet small enough to allow oxygen to flow to the windrow's core. The ideal pile width is between 14 and 16 feet.⁹⁵¹

Sources

1. Climate

- ¹ Doesken, N.J., R.A. Pielke, and O.A.P Bliss. "Climate of Colorado. Climatology of the United States." No. 60. *Colorado Climate Center and Colorado State University*. 2003. <http://www.wrcc.dri.edu/narratives/COLORADO.htm> Accessed on December 10, 2010.
- ² Kleist, J., N.T. Doesken, and T. McKee. "A snapshot of Colorado's climate during the 20th century." *Climo. Report 91-2, Dept. of Atmos. Sci., CSU Fort Collins, CO*. 1991
- ³ "A Look at Colorado Agriculture." *United States Department of Agriculture – Agriculture in the Classroom*. July 2010.
- ⁴ Doesken, N.J., R.A. Pielke, and O.A.P Bliss. "Climate of Colorado. Climatology of the United States." No. 60. *Colorado Climate Center and Colorado State University*. 2003. <http://www.wrcc.dri.edu/narratives/COLORADO.htm> Accessed on December 10, 2010.
- ⁵ Ibid.
- ⁶ Ibid.
- ⁷ Klett, J.E. and Feucht, J.R. "Colorado Gardening: Challenge to Newcomers." Colorado State University Extension Service. 2007
- ⁸ Doesken, N.J., R.A. Pielke, and O.A.P Bliss. "Climate of Colorado. Climatology of the United States." No. 60. *Colorado Climate Center and Colorado State University*. 2003. <http://www.wrcc.dri.edu/narratives/COLORADO.htm> Accessed on December 10, 2010.
- ⁹ McKee, T., N. Doesken, and J. Kleist, "Historical Dry and Wet Periods in Colorado." *Climatology Report 99-1, Part A: Technical Report. Dept. of Atmos. Sci., Colorado State University*. 1999.
- ¹⁰ Doesken, N.J., R.A. Pielke, and O.A.P Bliss. "Climate of Colorado. Climatology of the United States." No. 60. *Colorado Climate Center and Colorado State University*. 2003. <http://www.wrcc.dri.edu/narratives/COLORADO.htm> Accessed on December 10, 2010.
- ¹¹ Ibid.
- ¹² Ibid.
- ¹³ "30 Year Average Precipitation and Temperature for Longmont, Colorado." 2001. *High Plains Regional Climate Center*. http://www.hprcc.unl.edu/cgi-bin/cli_perl_lib/cliMAIN.pl?co5116
- ¹⁴ "Climate Summary Maps." *High Plains Regional Climate Center*. 2004. http://www.hprcc.unl.edu/cgi-bin/cli_perl_lib/cliMAIN.pl?co5116
- ¹⁵ Doesken, N.J., R.A. Pielke, and O.A.P Bliss. "Climate of Colorado. Climatology of the United States." No. 60. *Colorado Climate Center and Colorado State University*. 2003. <http://www.wrcc.dri.edu/narratives/COLORADO.htm> Accessed on December 10, 2010.
- ¹⁶ Barnett, T.P., D.W. Pierce, H.G. Hidalgo, C. Bonfils, et al. 2008: "Human-induced changes in the hydrology of the western United States." *Science*, 319(5866), 1080-1083
- ¹⁷ Gleick, P.H. "Regional hydrologic consequences of increases in atmospheric CO₂ and other trace gases." *Climatic Change*, 10(2), 137-160. 1988.
- ¹⁸ "Multi-Hazard Mitigation Plan." *City of Boulder*. January 2008. dola.colorado.gov/dem/mitigation/city_of_boulder_plan.pdf
- ¹⁹ Ibid.



- ²⁰ “Global Climate Change Impacts in the United States.” *U.S. Global Change Research Program*. 71-78. 2008. <http://www.globalchange.gov/images/cir/pdf/agriculture.pdf>.
- ²¹ Breshears, D.D., N.S. Cobb, P.M. Rich, K.P. Price, et al. “Regional vegetation die-off in response to global-change drought.” *Proceedings of the National Academy of Sciences*, 102(42), 15144-15148. 2005
- ²² “Southwest Regional Climate Impact.” *U.S. Global Change Research Program*. 2008. <http://www.globalchange.gov/images/cir/pdf/southwest.pdf>
- ²³ “Global Climate Change Impacts in the United States: Agriculture.” *U.S. Global Change Research Program*. 2008
- ²⁴ Griffiths, James et al. “Agricultural Ecosystems Facts and Trends.” *World Business Council for Sustainable Development and International Union for Conservation of Nature*. July 2008.
- ²⁵ Hatfield, J., K. Boote, P. Fay, L. Hahn, et al. Agriculture. “The Effects of Climate Change on Agriculture, Land Resources, Water Resources, and Biodiversity in the United States.” 2008.
- ²⁶ K. Boote, P. Fay, L. Hahn, C. Izaurralde, et al. “Synthesis and Assessment Product 4.3.” *U.S. Department of Agriculture*. Washington, DC, pp. 21-74.
- ²⁷ Hatfield, J., K. Boote, P. Fay, L. Hahn, et al. “The Effects of Climate Change on Agriculture, Land Resources, Water Resources, and Biodiversity in the United States.” *Agriculture*. 2008.
- ²⁸ K. Boote, P. Fay, L. Hahn, C. Izaurralde, et al. “Synthesis and Assessment Product 4.3.” *U.S. Department of Agriculture*. Washington, DC, pp. 21-74.
- ²⁹ Field, C.B., L.D. Mortsch, M. Brklacich, et al. “Climate Change 2007: Impacts, Adaptation and Vulnerability.” *Contribution of Working Group II to the Fourth Assessment Report of the Intergovernmental Panel on Climate Change*. Cambridge University Press, Cambridge, UK, and New York, pp. 617-652. 2007.
- ³⁰ Chase, Thomas N., R.A. Pielke Sr., T.G.F. Kittel, J.S. Baron, and T.J. Stohlgren. “Potential Impacts on Colorado Rocky Mountain Weather Due to Land Use Changes on the Adjacent Great Plains.” *Journal of Geophysical Research*. Vol. 104: No. D14 16,673-16,690. 27 July 1999. http://culter.colorado.edu:1030/~kittel/pdf_Chase99_JGR.pdf
- ³¹ Adams, Richard M., B.H. Hurd, S. Lenhart, and N. Leary. “Effects of Global Climate Change on Agriculture: An Interpretative Review.” *Climate Research*. Vol. 11: 19-30. 1998. <http://www.int-res.com/articles/cr/11/c011p019.pdf>
- ³² Chase, Thomas N., R.A. Pielke Sr., T.G.F. Kittel, J.S. Baron, and T.J. Stohlgren. “Potential Impacts on Colorado Rocky Mountain Weather Due to Land Use Changes on the Adjacent Great Plains.” *Journal of Geophysical Research*. Vol. 104: No. D14 16,673-16,690. 27 July 1999. http://culter.colorado.edu:1030/~kittel/pdf_Chase99_JGR.pdf
- ³³ Barnett, T.P., D.W. Pierce, H.G. Hidalgo, et al. “Human-induced changes in the hydrology of the western United States.” *Science*. 319(5866): 1080-1083. 2008.
- ³⁴ Pierce, D.W., T.P. Barnett, H.G. Hidalgo, et al. “Attribution of declining western U.S. snowpack to human effects.” *Journal of Climate*. 21(23): 6425-6444. 2008.
- ³⁵ Bonfils, C., B.D. Santer, D.W. Pierce, et al. “Detection and attribution of temperature changes in the mountainous western United States.” *Journal of Climate*. 21(23): 6404-6424. 2008.
- ³⁶ Adams, R.M., B.A. McCarl, D.J. Dudek, and J.D. Glycer. “Implications of Global Climate Change for Western Agriculture.” *Western Journal of Agricultural Economics*. Vol. 13 No 2: 351. 1988.
- ³⁷ Barnett, T.P., D.W. Pierce, H.G. Hidalgo, et al. “Human-induced changes in the hydrology of

- the western United States." *Science*. 319(5866): 1080-1083. 2008.
- ³⁸ Rauscher, S.A., J.S. Pal, N.S. Diffenbaugh, and M.M. Benedetti. "Future changes in snowmelt-driven runoff timing over the western United States." *Geophysical Research Letters*, 35, L16703, doi:10.1029/2008GL034424. 2008.
- ³⁹ Chase, Thomas N., R.A. Pielke Sr., T.G.F. Kittel, J.S. Baron, and T.J. Stohlgren. "Potential Impacts on Colorado Rocky Mountain Weather Due to Land Use Changes on the Adjacent Great Plains." *Journal of Geophysical Research*. Vol. 104: No. D14 16,673-16,690. 27 July 1999. http://culter.colorado.edu:1030/~kittel/pdf_Chase99_JGR.pdf
- ⁴⁰ Abler, D., R. Darwin, K. Fuglie, et al. "U.S. Agriculture and Climate Change: New Results." Kluwer Academic Publishers. *Climatic Change* 57: 52. 2003. <http://0-www.springerlink.com.bianca.penlib.du.edu/content/r20612355852572p/fulltext.pdf>.
- ⁴¹ Purkey, D.R., B. Joyce, S. Vicuna, et al. "Robust analysis of future climate change impacts on water for agriculture and other sectors: a case study in the Sacramento Valley." *Climatic Change* 87(Supplement 1): S109-S122. 2008.
- ⁴² "Southwest Regional Climate Impact." *U.S. Global Change Research Program*. 2008. <http://www.globalchange.gov/images/cir/pdf/southwest.pdf>
- ⁴³ Epstein, Paul R. "Climate Change and Human Health." *The New England Journal of Medicine* 353, no. 14: 1433-6. October 6, 2005. <http://0-www.proquest.com.bianca.penlib.du.edu/> (accessed December 17, 2010).
- ⁴⁴ Fuhrer, Jürg. "Agroecosystem responses to combinations of elevated CO₂, ozone, and global climate change." *ScienceDirect*. P 9-10. http://0-www.sciencedirect.com.bianca.penlib.du.edu/science?_ob=ArticleURL&_udi=B6T3Y-48BKXKD-1&_user=1497530&_coverDate=07%2F31%2F2003&_rdoc=1&_fmt=high&_orig=search&_origin=search&_sort=d&_docanchor=&view=c&_acct=C000053135&_version=1&_urlVersion=0&_userid=1497530&md5=44a9a80acbba2403e0e3170519274268&searchtype=a#toc9
- ⁴⁵ Ibid.
- ⁴⁶ Ibid.
- ⁴⁷ Ibid.
- ⁴⁸ "Briefing: State of Colorado Greenhouse Gas Inventory and Update on Current Activities." *Colorado Department of Public Health and Environment: Climate Change*. Colorado Air Quality Control Commission. 15 October 2009. <http://www.cdph.state.co.us/climate/#Greenhouse%20Gas%20Reports>
- ⁴⁹ Econergy, (Prepared by). "Boulder County, Colorado Greenhouse Gas Inventory Final Report." *Boulder County*. December 2006. www.bouldercounty.org/find/library/gogreen/susgreengasinv.pdf
- ⁵⁰ Ibid.
- ⁵¹ Ibid.
- ⁵² Isaac, A.S. "Boulder County Leads Way in Sustainable Energy." *Boulder Weekly*. March 25, 2010. <http://npaper-wehaa.com/boulder-weekly/2010/03/25/s1/#?article=810676&z=51>.
- ⁵³ Econergy, (Prepared by). "Boulder County, Colorado Greenhouse Gas Inventory Final Report." *Boulder County*. December 2006. www.bouldercounty.org/find/library/gogreen/susgreengasinv.pdf
- ⁵⁴ Ibid.

- ⁵⁵ Mosier, A.R. "Exchange of gaseous nitrogen compounds between agricultural systems and the atmosphere." *Plant and Soil*, 228, pp. 17- 27. 2001.
- ⁵⁶ Archer, D.W. and A.D. Halvorson. "Greenhouse Gas Mitigation Economics for Irrigated Cropping Systems in Northeastern Colorado." *Soil Science Society of America*. Vol. 74, 2: 446-452. 2010.
- ⁵⁷ Bellarby, Jessica, B. Foereid, A. Hastings, and P. Smith. "Cool Farming: Climate Impacts of Agriculture and Mitigation Potential." *Greenpeace Report*. January 2008.
<http://www.greenpeace.org/raw/content/international/press/reports/cool-farming-full-report.pdf>
- ⁵⁸ West, T.O., and G. Marland. "Net carbon flux from agriculture: Carbon emissions, carbon sequestration, crop yield, and land-use change." *Biogeochemistry*. 63: 73–83. 2003.
- ⁵⁹ Smith, P., et al. (2007): Agriculture. In *Climate Change (2007): Mitigation. Contribution of Working Group III to the Fourth Assessment Report of the Intergovernmental Panel on Climate Change* [B. Metz, O.R. Davidson, P.R. Bosch, R. Dave, L.A. Meyer (eds)], Cambridge University Press, Cambridge, United Kingdom and New York, NY, USA. Available at
http://www.mnp.nl/ipcc/pages_media/FAR4docs/final_pdfs_ar4/Chapter08.pdf
- ⁶⁰ Smith, P., D. Martino, Z. Cai, et al. "Ch 8: Agriculture. Climate Change 2007: Mitigation. Contribution of Working Group III to the Fourth Assessment Report of the Intergovernmental Panel on Climate Change." *Cambridge University Press*, Cambridge, United Kingdom and New York, NY, USA. 2007. <http://www.ipcc.ch/pdf/assessment-report/ar4/wg3/ar4-wg3-chapter8.pdf>
- ⁶¹ Post, W.M., R.C. Izaurralde, and J.D. Jastrow. Enhancement of sequestration in US soils. *Bioscience* 54: 895–908. 2004.
- ⁶² Smith, P., D. Martino, Z. Cai, et al. "Ch 8: Agriculture. Climate Change 2007: Mitigation. Contribution of Working Group III to the Fourth Assessment Report of the Intergovernmental Panel on Climate Change." *Cambridge University Press*, Cambridge, United Kingdom and New York, NY, USA. 2007. <http://www.ipcc.ch/pdf/assessment-report/ar4/wg3/ar4-wg3-chapter8.pdf>
- ⁶³ Smith, P., D. Martino, Z. Cai, D. Gwary, et al. "Greenhouse gas mitigation in agriculture." *Philosophical Transactions of the Royal Society, B.*, 363.doi:10.1098/rstb.2007.2184. 2007.
- ⁶⁴ Cole, C.V., J. Duxbury, J. Freney, et al. "Global estimates of potential mitigation of greenhouse gas emissions by agriculture." *Nutrient Cycling in Agroecosystems* 49: pp. 221-228. 1997.
- ⁶⁵ Houghton, J.T., Y. Ding, D.J. Griggs, et al. "Climate Change 2001: The Scientific Basis. Contribution of Working Group I to the Third Assessment Report of the Intergovernmental Panel on Climate Change." *Cambridge University Press*. 881 pp 2001.
- ⁶⁶ Paustian, K., B.A. Babcock, J. Hatfield, et al. "Agricultural Mitigation of Greenhouse Gases: Science and Policy Options." *CAST (Council on Agricultural Science and Technology) Report*. R141 2004, 120 pp. 2004.
- ⁶⁷ Bouwman, A. "Global Estimates of Gaseous Emissions from Agricultural Land." *FAO, Rome*, 106 pp. 2001.
- ⁶⁸ Clemens, J. and H.J. Ahlgrimm. "Greenhouse gases from animal husbandry: mitigation options. *Nutrient Cycling in Agroecosystems*." 60, pp. 287-300. 2001.
- ⁶⁹ Smith, P., D. Martino, Z. Cai, et al. "Ch 8: Agriculture. Climate Change 2007: Mitigation. Contribution of Working Group III to the Fourth Assessment Report of the

- Intergovernmental Panel on Climate Change." *Cambridge University Press*, Cambridge, United Kingdom and New York, NY, USA. 2007. <http://www.ipcc.ch/pdf/assessment-report/ar4/wg3/ar4-wg3-chapter8.pdf>
- ⁷⁰ Schils, R.L.M., A. Verhagen, H.F.M. Aarts, and L.B.J. Sebek. "A farm level approach to define successful mitigation strategies for GHG emissions from ruminant livestock systems." *Nutrient Cycling in Agroecosystems*, 71: pp. 163-175. 2005.
- ⁷¹ Koga, N., T. Sawamoto, and H. Tsuruta. "Life cycle inventory-based analysis of greenhouse gas emissions from arable land farming systems in Hokkaido, northern Japan." *Soil Science and Plant Nutrition*, 52: pp. 564-574. 2006.
- ⁷² Six, J., S.M. Ogle, F.J. Breidt, et al. "The potential to mitigate global warming with no-tillage management is only realized when practiced in the long term." *Global Change Biology*, 10: pp.155-160. 2004.
- ⁷³ Marland, G., R.A. Pielke Jr., M. Apps, et al. "The climatic impacts of land surface change and carbon management, and the implications for climate-change mitigation policy." *Climate Policy*, 3: pp. 149-157. 2003.
- ⁷⁴ Adapted from *IPCC Fourth Assessment Report* and Smith, P. "Carbon sequestration in croplands: the potential in Europe and the global context." *European Journal of Agronomy*, 20: pp. 229-236. 2004.
- ⁷⁵ McSwiney, C.P. and G.P. Robertson. "Nonlinear response of N₂O flux to incremental fertilizer addition in a continuous maize (*Zea mays* L.) cropping system." *Global Change Biology*, 11: pp. 1712-1719. 2005
- ⁷⁶ Galloway, J.N. "The global nitrogen cycle." *Treatise on Geochemistry*, 8: pp. 557-583. 2003.
- ⁷⁷ Cassman, K.G., A. Dobermann, D.T. Walters, and H. Yang. "Meeting cereal demand while protecting natural resources and improving environmental quality." *Annual Review of Environment and Resources*, 28: pp. 315-358. 2003.
- ⁷⁸ Schlesinger, W.H. "Carbon sequestration in soils." *Science*, 284: pp. 2095.1999.
- ⁷⁹ Robertson, G.P. "Abatement of nitrous oxide, methane and other non-CO₂ greenhouse gases: the need for a systems approach." *The global carbon cycle. Integrating Humans, Climate, and the Natural World*, C.B. Field, and M.R. Raupach (eds.). SCOPE 62, Island Press, Washington D.C., pp. 493-506. 2004.
- ⁸⁰ Paustian, K., B.A. Babcock, J. Hatfield, R. Lal, et al. "Agricultural Mitigation of Greenhouse Gases: Science and Policy Options." *CAST (Council on Agricultural Science and Technology) Report*. R141: 120 pp. 2004.
- ⁸¹ Cole, C.V., J. Duxbury, J. Freney, et al. "Global estimates of potential mitigation of greenhouse gas emissions by agriculture." *Nutrient Cycling in Agroecosystems*, 49: pp. 221-228. 1997.
- ⁸² Monteny, G.-J., A. Bannink, and D. Chadwick. "Greenhouse gas abatement strategies for animal husbandry." *Agriculture, Ecosystems and Environment*, 112: pp. 163-170. 2006.
- ⁸³ Dalal, R.C., W. Wang, G.P. Robertson, and W.J. Parton. "Nitrous oxide emission from Australian agricultural lands and mitigation options: a review." *Australian Journal of Soil Research*, 41: pp. 165-195. 2003.
- ⁸⁴ Follett, R.F. "Organic carbon pools in grazing land soils." *The Potential of U.S. Grazing Lands to Sequester Carbon and Mitigate the Greenhouse Effect*. R.F. Follett, J.M. Kimble, and R. Lal (eds.), Lewis Publishers, Boca Raton, Florida, pp. 65-86. 2001.
- ⁸⁵ Follett, R.F., S.R. Shafer, M.D. Jawson, and A.J. Franzluebbers. "Research and implementation needs to mitigate greenhouse gas emissions from agriculture in the

- USA." *Soil and Tillage Research*, 83: pp. 159-166. 2005.
- ⁸⁶ West, T.O. and W.M. Post. "Soil organic carbon sequestration rates by tillage and crop rotation: A global data analysis." *Soil Science Society of America Journal*, 66: pp. 1930-1946. 2002.
- ⁸⁷ Lal, R. "Global potential of soil carbon sequestration to mitigate the greenhouse effect." *Critical Reviews in Plant Sciences*, 22: pp. 151- 184. 2003.
- ⁸⁸ Lal, R. "Soil carbon sequestration impacts on global climate change and food security." *Science*, 304: pp. 1623-1627. 2004.
- ⁸⁹ Smith, P. "Carbon sequestration in croplands: the potential in Europe and the global context." *European Journal of Agronomy*, 20: pp. 229- 236. 2004.
- ⁹⁰ Alvarez, R. "A review of nitrogen fertilizer and conservative tillage effects on soil organic storage." *Soil Use and Management*, 21: pp. 38-52. 2005.
- ⁹¹ Schlesinger, W.H. "Carbon sequestration in soils." *Science*, 284: pp. 2095. 1999.
- ⁹² Robertson, G.P. "Abatement of nitrous oxide, methane and other non-CO₂ greenhouse gases: the need for a systems approach." *The global carbon cycle. Integrating Humans, Climate, and the Natural World*, C.B. Field, and M.R. Raupach (eds.). SCOPE 62, Island Press, Washington D.C., pp. 493-506. 2004.
- ⁹³ Gregorich, E.G., P. Rochette, A.J. van den Bygaart, and D.A. Angers. "Greenhouse gas contributions of agricultural soils and potential mitigation practices in Eastern Canada." *Soil and Tillage Research*, 83: pp. 53-72. 2005.
- ⁹⁴ Helsel, Z.R. "Energy and alternatives for fertilizer and pesticide use." University of California: Sustainable Agriculture Research and Education Program. 1993 Vol 5. No. 5 <http://www.sarep.ucdavis.edu/newsltr/v5n5/sa-12.htm>
- ⁹⁵ Christine A. Bahlai, Yingen Xue, Cara M. McCreary, Arthur W. Schaafsma, Rebecca H. Hallett. "Choosing Organic Pesticides over Synthetic Pesticides May Not Effectively Mitigate Environmental Risk in Soybeans." *PLoS ONE*, 2010
- ⁹⁶ Paustian, K., B.A. Babcock, J. Hatfield, R. Lal, et al. "Agricultural Mitigation of Greenhouse Gases: Science and Policy Options." *CAST (Council on Agricultural Science and Technology) Report*, R141, 120 pp. 2004.
- ⁹⁷ West, T.O. and W.M. Post. "Soil organic carbon sequestration rates by tillage and crop rotation: A global data analysis." *Soil Science Society of America Journal*, 66: pp. 1930-1946. 2002.
- ⁹⁸ Rochette, P. and H.H. Janzen. "Towards a revised coefficient for estimating N₂O emissions from legumes." *Nutrient Cycling in Agroecosystems*, 73: pp. 171-179. 2005.
- ⁹⁹ Barthès, B., A. Azontonde, E. Blanchart, C. Girardin, et al. "Effect of a legume cover crop (*Mucuna pruriens* var. *utilis*) on soil carbon in an Ultisol under maize cultivation in southern Benin." *Soil Use and Management*, 20: pp. 231- 239. 2004.
- ¹⁰⁰ Freibauer, A., M. Rounsevell, P. Smith, and A. Verhagen. "Carbon sequestration in the agricultural soils of Europe." *Geoderma*, 122: pp.1-23. 2004.
- ¹⁰¹ Badgley, C., Moghtader, J., Quintero, E., Zakem, E., Jahi Chappell, M., Avilés-Vázquez, K., Samulon, A. and Perfecto, I. "Organic agriculture and the global food supply." *Renewable Agriculture and Food Systems*. 2007. 22(2); 86-108.
- ¹⁰² Niggli, Urs., et al. "Organic Farming and Climate Change." International Trade Centre and Research institute of Organic Agriculture. 2007
- ¹⁰³ Alluvione, F., A.D. Halvorson, and S.J. Del Grosso. "Nitrogen, tillage, and crop rotation effects

- on carbon dioxide and methane fluxes from irrigated cropping systems." *J. Environ. Qual.* 38: 2023–2033. 2009.
- ¹⁰⁴ West, T.O., and G. Marland. "A synthesis of carbon sequestration, carbon emissions, and net carbon flux in agriculture: Comparing tillage practices in the United States." *Agric. Ecosyst. Environ.* 91: 217–232. 2002.
- ¹⁰⁵ Ogle, S.M., F.J. Breidt, M.D. Eve, and K. Paustian. "Uncertainty in estimating land use and management impacts on soil organic storage for US agricultural lands between 1982 and 1997." *Global Change Biology*, 9: pp. 1521-1542. 2003.
- ¹⁰⁶ Alvarez, R. "A review of nitrogen fertilizer and conservative tillage effects on soil organic storage." *Soil Use and Management*, 21: pp. 38-52. 2005.
- ¹⁰⁷ Entry, J.A., R.E. Sojka, and G.E. Shewmaker. "Management of irrigated agriculture to increase organic carbon storage in soils." *Soil Sci. Soc. Am. J.* 66: 1957–1964. 2002.
- ¹⁰⁸ Mosier, A.R., A.D. Halvorson, C.A. Reule, and X.J. Liu. "Net global warming potential and greenhouse gas intensity in irrigated cropping systems in northeastern Colorado." *J. Environ. Qual.* 35: 1584–1598. 2006.
- ¹⁰⁹ Halvorson, A.D., R.F. Follett, C.A. Reule, and S. Del Grosso. "Soil organic carbon and nitrogen sequestration in irrigated cropping systems of the Central Great Plains." p. 141–157. *R. Lal and R.F. Follett (ed.) Soil carbon sequestration and the greenhouse effect.* Spec. Publ. 57. 2nd ed. SSSA, Madison, WI. 2009.
- ¹¹⁰ Entry, J.A., R.E. Sojka, and G.E. Shewmaker. "Management of irrigated agriculture to increase organic carbon storage in soils." *Soil Sci. Soc. Am. J.* 66: 1957–1964. 2002.
- ¹¹¹ Mosier, A.R., A.D. Halvorson, C.A. Reule, and X.J. Liu. "Net global warming potential and greenhouse gas intensity in irrigated cropping systems in northeastern Colorado." *J. Environ. Qual.* 35: 1584–1598. 2006.
- ¹¹² Fox, G., A. Weersink, G. Sarwar, S. Duff, and B. Deen. "Comparative economics of alternative agricultural production systems: A review." *Northeast. J. Agric. Resour. Econ.* 20: 124–142. 1991.
- ¹¹³ Manley, J., G. van Kooten, K. Moeltner, and D. Johnson. "Creating carbon off sets in agriculture through no-till cultivation: A meta-analysis of costs and carbon benefits." *Clim. Change*, 68: 41–65. 2005.
- ¹¹⁴ Wiese, A.F., T.H. Marek, and W.L. Harman. "No-tillage increases profits in a limited irrigation–dryland system." *J. Prod. Agric.* 11: 247–252. 1998.
- ¹¹⁵ Archer, D.W., A.D. Halvorson, and C.A. Reule. "Economics of irrigated continuous corn under conventional-till and no-till in northern Colorado." *Agron. J.* 100: 1166–1172. 2008.
- ¹¹⁶ Wiese, A.F., T.H. Marek, and W.L. Harman. "No-tillage increases profits in a limited irrigation–dryland system." *J. Prod. Agric.* 11: 247–252. 1998.
- ¹¹⁷ Archer, D.W. and A.D. Halvorson. "Greenhouse Gas Mitigation Economics for Irrigated Cropping Systems in Northeastern Colorado." *Soil Science Society of America.* Vol. 74(2): 446-452. 2010.
- ¹¹⁸ Ibid.
- ¹¹⁹ Smith, K.A. and F. Conen. "Impacts of land management on fluxes of trace greenhouse gases." *Soil Use and Management*, 20: pp. 255-263. 2004.
- ¹²⁰ Helgason, B.L., H.H. Janzen, M.H. Chantigny, C.F. Drury, et al. "Toward improved coefficients for predicting direct N₂O emissions from soil in Canadian agroecosystems." *Nutrient Cycling in Agroecosystems*, 71: pp. 87-99. 2005:

-
- ¹²¹ Li, C., S. Frohling, and K. Butterbach-Bahl. "Carbon sequestration in arable soils is likely to increase nitrous oxide emissions, offsetting reductions in climate radiative forcing." *Climatic Change*, 72: pp. 321-338. 2005.
- ¹²² Mosier, A.R., A.D. Halvorson, C.A. Reule, and X.J. Liu. "Net global warming potential and greenhouse gas intensity in irrigated cropping systems in northeastern Colorado." *J. Environ. Qual.* 35: 1584–1598. 2006.
- ¹²³ Wiese, A.F., T.H. Marek, and W.L. Harman. "No-tillage increases profits in a limited irrigation–dryland system." *J. Prod. Agric.* 11: 247–252. 1998.
- ¹²⁴ Archer, D.W. and A.D. Halvorson. "Greenhouse Gas Mitigation Economics for Irrigated Cropping Systems in Northeastern Colorado." *Soil Science Society of America*. Vol. 74(2): 446-452. 2010.
- ¹²⁵ Marland, G., B.A. McCarl, and U.A. Schneider. "Soil carbon: policy and economics." *Climatic Change*, 51: pp. 101-117. 2001.
- ¹²⁶ Blanco-Canqui, Humberto and R. Lal. "No-Tillage and Soil-Profile Carbon Sequestration: An On-Farm Assessment." *Soil Science Society of America Journal*. Vol. 72(3): pp. 693-701. 2008.

2. Energy

- ¹²⁷ Pirog, Rich. "Energy Efficiency as an Integral Part of Sustainable Agriculture." *ACEEE Forum on Energy Efficiency in Sustainable Agriculture*. Leopold Center for Sustainable Agriculture. Iowa State University. 16 November 2005.
<http://www.leopold.iastate.edu/organic/orgvconv/index.html>
- ¹²⁸ Ho, Mae-Wan and Lim Li Ching. "Mitigating Climate Change through Organic Agriculture and Localized Food Systems." *Institute of Science and Society*. 31 January 2008. <http://www.i-sis.org.uk/mitigatingClimateChange.php>
- ¹²⁹ To calculate this value, two datasets are used. Emissions from energy use come from: *U.S. Department of Agriculture (USDA)*, "U.S. Agriculture and Forestry Greenhouse Gas Inventory: 1990-2005." 2008. Emissions from non-energy use come from: *Environmental Protection Agency (EPA)*, "Inventory of U.S. Greenhouse Gas Emissions and Sinks: 1990-2007." 2009.
- ¹³⁰ Schnepf, Randy. "Energy Use in Agriculture: Background and Issues." *Congressional Research Service Report for congress: Received through the CRS Web*. Order Code RL32677. 2004.
www.nationalaglawcenter.org/assets/crs/RL32677.pdf
- ¹³¹ Miranowski, John. "Energy Consumption in U.S. Agriculture," presentation at USDA conference on *Agriculture as a Producer and Consumer of Energy*, June 24, 2004. Conference proceedings are available at <http://www.farmfoundation.org/projects/03-35EnergyConferencepresentations.htm>.
- ¹³² Ibid.
- ¹³³ Ibid.
- ¹³⁴ Schnepf, Randy. "Energy Use in Agriculture: Background and Issues." *CSR Report for congress: Received through the CRS Web*. Order Code RL32677. 2004.
www.nationalaglawcenter.org/assets/crs/RL32677.pdf
- ¹³⁵ Miranowski, John. "Energy Consumption in U.S. Agriculture," presentation at USDA conference on *Agriculture as a Producer and Consumer of Energy*. June 24, 2004. Conference proceedings are available at <http://www.farmfoundation.org/projects/03-35EnergyConferencepresentations.htm>.
- ¹³⁶ Ziesemer, Joel. "Energy Use in Organic Food Systems". Food and Agriculture Organization of the United Nations, Natural Resources Management and Environment Department. August 2007.
- ¹³⁷ Aubert, C., Leclerc, B. 2003. *Bio Raisonnée OGM : Quelle agriculture dans notre assiette ? terre vivante*, Mens, France.
- ¹³⁸ Soil Association. 2006. *Organic Works: Providing more jobs through organic farming and local food supply*. Bristol House, Bristol.
- ¹³⁹ Kasperczyk, N., Knickel, K. 2006. "Chapter 12: Environmental impacts of organic farming." *Organic Agriculture: A Global Perspective*. Editors Kristiansen, P., Taji, A., Reganold, J. Cornell University Press, Ithaca, NY.
- ¹⁴⁰ Pimentel, D. 2006. "Impacts of Organic Farming on the Efficiency of Energy Use in Agriculture." The Organic Center, Cornell University.
- ¹⁴¹ Ziesemer, Joel. "Energy Use in Organic Food Systems". Food and Agriculture Organization of the United Nations, Natural Resources Management and Environment Department. August 2007.
- ¹⁴² Shapouri, H., Duffield, J. A., and Wang, M., 2002, The energy balance of corn ethanol: an update: USDA, Office of Energy Policy and New Uses, Agricultural Economics. Rept. No. 813. 14 p.

- ¹⁴³ Hoepfner, J., Hentz, M., McConkey, B., Zentner, R., Nagy, C. 2006. "Energy use and efficiency in two Canadian organic and conventional crop production systems" *Renewable Agriculture and Food Systems*: 21(1): 60-67.
- ¹⁴⁴ Williams, A., Audsley, E., Sandars, D. 2006. "Determining the environmental burdens and resource use in the production of agricultural and horticultural commodities." Main Report. Defra Research Project IS0205. Bedford: Cranfield University and Defra. Available from www.silsoe.cranfield.ac.uk and www.defra.gov.uk.
- ¹⁴⁵ Stolze, M., Piorr, A., Häring, A., Dabbert, S. 2000. "The Environmental Impacts of Organic Farming in Europe." *Organic Farming in Europe: Economics and Policy, Volume 6*. University of Hohenheim Department of Farm Economics, Stuttgart.
- ¹⁴⁶ Bos, J., Haan, J., Sukkel, W., Schils, R. 2007. "Comparing energy use and greenhouse gas emissions in organic and conventional farming systems in the Netherlands." Paper presented at the 3rd QLIF Congress: *Improving Sustainability in Organic and Low Input Food Production Systems*. University of Hohenheim, Stuttgart.
- ¹⁴⁷ Pimental, David. "Impacts of Organic Farming on the Efficiency of Energy Use in Agriculture." The Organic Center. August 2006.
- ¹⁴⁸ Schnepf, Randy. "Energy Use in Agriculture: Background and Issues." *Congressional Research Service Report for congress: Received through the CRS Web*. Order Code RL32677. 2004. www.nationalaglawcenter.org/assets/crs/RL32677.pdf
- ¹⁴⁹ Miranowski, John A. "Energy Consumption in US Agriculture." *Agriculture as a Producer and Consumer of Energy Conference*. June, 2004. Sourced from www.farmfoundation.org.
- ¹⁵⁰ Schnepf, Randy. "Energy Use in Agriculture: Background and Issues." *Congressional Research Service Report for congress: Received through the CRS Web*. Order Code RL32677. Table 5. 2004. www.nationalaglawcenter.org/assets/crs/RL32677.pdf
- ¹⁵¹ Ibid.
- ¹⁵² Miranowski, John. "Energy Consumption in U.S. Agriculture," presentation at USDA conference on *Agriculture as a Producer and Consumer of Energy*, June 24, 2004. Conference proceedings are available at <http://www.farmfoundation.org/projects/03-35EnergyConferencepresentations.htm>.
- ¹⁵³ M.H. Ross and D. Steinmeyer. "Energy for Industry." *Scientific American*. p. 88-98. September 1990.
- ¹⁵⁴ Schnepf, Randy. "Energy Use in Agriculture: Background and Issues." *Congressional Research Service Report for congress: Received through the CRS Web*. Order Code RL32677. Table 5. 2004. www.nationalaglawcenter.org/assets/crs/RL32677.pdf
- ¹⁵⁵ Ibid.
- ¹⁵⁶ Ibid.
- ¹⁵⁷ Koopmans, C., Zanen, M. "Nitrogen Efficiency in Organic Farming Using GPS Precision Farming Technique." from *Researching Sustainable Systems: First Scientific Conference of the International Society of Organic Agriculture Research (ISOFAR)*. Research Institute of Organic Agriculture, Switzerland. 2005.
- ¹⁵⁸ Schnepf, Randy. "Energy Use in Agriculture: Background and Issues." *Congressional Research Service Report for congress: Received through the CRS Web*. Order Code RL32677. Table 5. 2004. www.nationalaglawcenter.org/assets/crs/RL32677.pdf
- ¹⁵⁹ C.W. Gellings, K.E. Parmenter. 2004. Energy efficiency in fertilizer production and use. In: Gellings CW and Blok K [Eds.]. *Efficient use and conservation of energy*. In Encyclopedia of Life Support Systems (EOLSS), Developed under the auspices of the UNESCO, EOLSS Publishers, Oxford, UK. pp. 1-15.

- ¹⁶⁰ Ibid.
- ¹⁶¹ "2008 Farm and Ranch Irrigation Survey." *U.S. Department of Agriculture: Census of Agriculture, National Agricultural Statistics Service*. Washington, D.C. Vol. 3. July 2010.
- ¹⁶² Loftis, J.C. and D.L. Miles. "Irrigation Pumping Plant Efficiency." *Colorado State University Cooperative Extension Service*, Fort Collins, CO. p 4. 2004.
www.ext.colostate.edu/pubs/crops/04712.html
- ¹⁶³ Black, Richard D. and D. H. Rogers. "Evaluating Pumping Plant Efficiency Using On-Farm Fuel Bills." *Kansas State University Cooperative Extension Service*, Manhattan, Kansas. p 4. 1993.
- ¹⁶⁴ Morris, Mike and V. Lynne. "2006 NCAT Energy Saving Tips for Irrigators." *ATTRA - National Sustainable Agriculture Information Service*. 2006.
- ¹⁶⁵ Yedidiah, S. "Fluid Movers: Pumps Compressors, Fans and Blowers" *Chemical Engineering*. 1979 McGraw-Hill Companies and ASHRAE. 1996.
- ¹⁶⁶ "Agricultural Pumping Efficiency Improvements." *Pacific Gas and Electric Company*. May 1997.
- ¹⁶⁷ "Energy in Agriculture Program." *California Energy Commission*. 15 January 2009.
<http://www.energy.ca.gov/process/agriculture/index.html>.
- ¹⁶⁸ "Energy Efficiency in Agriculture." *Washington State Department of Agriculture*. 16 June 2008.
<http://agr.wa.gov/Bioenergy/EnergyEfficiency.aspx>.
- ¹⁶⁹ Svejksky, Cathy. "NCAT Energy Specialist Conserving Fuel on the Farm." *ATTRA - National Sustainable Agriculture Information Service*. 2007.
- ¹⁷⁰ Miranowski, John. "Energy Consumption in U.S. Agriculture," presentation at USDA conference on *Agriculture as a Producer and Consumer of Energy*, June 24, 2004. Conference proceedings are available at <http://www.farmfoundation.org/projects/03-35EnergyConferencepresentations.htm>.
- ¹⁷¹ Anderson, Margot. "Agricultural Resources and Environmental Indicators." *USDA ERS Agricultural Handbook*. No. 705. p. 108. December 1994.
- ¹⁷² "Energy Efficiency Farm Tips." *Utilities Consumer Advocate (UCA)*. Posting by the Alberta Government. 2006. <http://www.ucahelps.gov.ab.ca/213.html>
- ¹⁷³ "Conservation Practices that Save: Crop Residue Management." *U.S. Department of Agriculture (USDA) Natural Resource Conservation Service*. 2010.
<http://www.nrcs.usda.gov/TECHNICAL/energy/cropres.html>.
- ¹⁷⁴ Schnepf, Randy. "Energy Use in Agriculture: Background and Issues." *Congressional Research Service Report for congress: Received through the CRS Web*. Order Code RL32677. Table 5. 2004. www.nationalaglawcenter.org/assets/crs/RL32677.pdf.
- ¹⁷⁵ "Conservation Practices that Save: Crop Residue Management." *U.S. Department of Agriculture (USDA) Natural Resource Conservation Service*.
<http://www.nrcs.usda.gov/TECHNICAL/energy/cropres.html>
- ¹⁷⁶ Smolik, J., Dobbs, T., Rickerl, D. "The relative sustainability of alternative, conventional, and reduced-till systems." *American Journal of Alternative Agriculture* 10: 25-35. 1995.
- ¹⁷⁷ Labonte, Marc, and G. Makinen. "Energy Independence: Would it Free the United States From Oil Price Shocks?" CRS Report RS20727. *National Council for Science and the Environment*. 2000. <http://www.ncseonline.org/nle/crsreports/energy/eng-74.pdf> [A discussion of energy independence and its potential consequences on the U.S. economy.]
- ¹⁷⁸ Schnepf, Randy. "CRS Report for Congress Agriculture-Based Renewable Energy Production: RL32712." *Congressional Research Service*. January 4, 2005.
ncseonline.org/NLE/CRSreports/05Jan/RL32712.pdf

- ¹⁷⁹ Schnepf, Randy. "Energy Use in Agriculture: Background and Issues. RL32677." *Congressional Research Service Report for congress*. 2004.
www.nationalaglawcenter.org/assets/crs/RL32677.pdf.
- ¹⁸⁰ Schnepf, Randy. "CRS Report for Congress Agriculture-Based Renewable Energy Production: RL32712." *Congressional Research Service*. January 4, 2005.
ncseonline.org/NLE/CRSreports/05Jan/RL32712.pdf
- ¹⁸¹ Ibid.
- ¹⁸² "2007 Census of Agriculture: Colorado State and County Data." *United States Department of Agriculture National Agricultural Statistics Service*. December 2009.
http://www.agcensus.usda.gov/Publications/2007/Full_Report/Volume_1,_Chapter_1_State_Level/Colorado/cov1.pdf.
- ¹⁸³ Mumma, Tracy. (NCAT Agricultural Energy Specialist) "Efficient Agricultural Buildings: An Overview." *ATTRA*. 2002. attra.ncat.org/attra-pub/PDF/agbuildings.pdf
- ¹⁸⁴ Odeh, I, Y.G. Yohanis, and B. Norton. "Economic viability of photovoltaic water pumping systems." *Solar Energy*. 80 pp. 850-860. 2006. www.sciencedirect.com.
- ¹⁸⁵ Schnepf, Randy. "CRS Report for Congress Agriculture-Based Renewable Energy Production: RL32712." *Congressional Research Service*. January 4, 2005.
ncseonline.org/NLE/CRSreports/05Jan/RL32712.pdf
- ¹⁸⁶ Ibid.
- ¹⁸⁷ Rascalli, Ann. "Xcel Cuts Solar Incentives – Effective Immediately" *Colorado Energy News*. February 2011. <http://coloradoenergynews.com/2011/02/xcel-energy-reduces-solar-incentives-effective-immediately/>
- ¹⁸⁸ "The Economics of Wind Energy." *American Wind Energy Association*. March 2002.
<http://www.awea.org>
- ¹⁸⁹ Ibid.
- ¹⁹⁰ "Renewable Energy: Wind Power's Contribution to Electric Power Generation and Impact on Farms and Rural Communities." *Government Accountability Office (GAO)*. GAO-04-756, Sept. 2004. [An average U.S. household consumes roughly 10,000 kWh per year.]
- ¹⁹¹ Fortson, Leigh. "Wind energy in Colorado: A Practical Guide for Farmers and Ranchers About producing energy from wind." *Western Sustainable Agriculture Research and Education (WSARE) and Colorado State University Cooperative Extension*.
<http://www.coopext.colostate.edu/WR/windbooklet.pdf>
- ¹⁹² "Colorado 50-Meter Wind Resource Map." *United States Department of Energy: Energy Efficiency and Renewable Energy*. October 2010
http://www.windpoweringamerica.gov/maps_template.asp?stateab=CO
- ¹⁹³ Schnepf, Randy. "CRS Report for Congress Agriculture-Based Renewable Energy Production: RL32712." *Congressional Research Service*. January 4, 2005.
ncseonline.org/NLE/CRSreports/05Jan/RL32712.pdf
- ¹⁹⁴ Von Blottnitz, Harro, and M. A. Curran. "A review of assessments conducted on bio-ethanol as a transportation fuel from a net energy, greenhouse gas, and environmental life cycle perspective." *Journal of Cleaner Production: ScienceDirect*. 2006.
http://www2.bren.ucsb.edu/~writing/biofuel_jcp.pdf
- ¹⁹⁵ Schnepf, Randy. "CRS Report for Congress Agriculture-Based Renewable Energy Production: RL32712." *Congressional Research Service*. January 4, 2005.
ncseonline.org/NLE/CRSreports/05Jan/RL32712.pdf

- ¹⁹⁶ Renewable Fuels Association, Historic U.S. Fuel Ethanol Production, *National Biodiesel Board*. Production Capacity. 2008. Image from: <http://www.pewclimate.org/technology/overview/biofuels>
- ¹⁹⁷ Runge, C. Ford and B. Senauer. "How Biofuels could starve the poor." *Foreign Affairs*. May/June 2007. <http://www.foreignaffairs.com/articles/62609/c-ford-runge-and-benjamin-senauer/how-biofuels-could-starve-the-poor>
- ¹⁹⁸ "Colorado Incentives and Laws for Ethanol." U.S. Department of Energy. 2011. <http://www.afdc.energy.gov/afdc/laws/laws/CO/tech/3252>
- ¹⁹⁹ "Section 9005 Bioenergy Program for Advanced Biofuels Payments to Advanced Biofuel Producers." *USDA Rural Development*. Development. <http://www.rurdev.usda.gov/rbs/busp/9005Biofuels.htm>
- ²⁰⁰ Schnepf, Randy. "CRS Report for Congress Agriculture-Based Renewable Energy Production: RL32712." *Congressional Research Service*. January 4, 2005. ncseonline.org/NLE/CRSreports/05Jan/RL32712.pdf
- ²⁰¹ Ibid.
- ²⁰² Pacheco, M. "U.S. Senate Full Committee Hearing—Renewable Fuel Standards" National Renewable Energy Laboratory, National Bioenergy Center, 19 June 2006.
- ²⁰³ Shapouri, J. A. Duffield, M. S. Graboski "U.S. Department of Agriculture, Estimating the Net Energy Balance of Corn Ethanol," U.S. Department of Agriculture, Economic Research Service, Office of Energy, Agricultural Economic Report No. 721. www.ers.usda.gov/publications/aer721/AER721.PDF.
- ²⁰⁴ Hill, Jason, E. Nelson, D. Tilman, et al. "Environmental, economic, and energetic costs and benefits of biodiesel and ethanol biofuels." *Proceedings of the National Academy of Sciences of the United States of America*. 2006. <http://www.pnas.org/content/103/30/11206.long>
- ²⁰⁵ Pimentel, David. "Ethanol Fuels: Energy Balance, Economics, and Environmental Impacts are Negative." *Natural Resources Research*. June 2003. Vol. 12. No. 2
- ²⁰⁶ US DOE Energy Efficiency and Renewable Energy "Ethanol: the complete energy lifecycle picture" March 2007
- ²⁰⁷ Ibid.
- ²⁰⁸ Nonhebel, Sanderine. "Renewable energy and food supply: will there be enough land?" *Centre for Energy and Environmental Studies*, University of Groningen, The Netherlands. *Renewable and Sustainable Energy Reviews*. 2004. <http://ivem.eldoc.ub.rug.nl/ivempubs/publart/2005/RenSustEnRevNonhebel/>
- ²⁰⁹ McKendry, Peter. "Energy production from biomass (part 1): overview of biomass." *Bioresource Technology*. 2001. <http://faculty.washington.edu/stevehar/Biomass-Overview.pdf>
- ²¹⁰ "Anaerobic Digestion: Methane (Biogas) from Anaerobic Digesters." *Department of Energy: Energy Efficiency & Renewable Energy*. 2001. http://www.eere.energy.gov/basics/renewable_energy/anaerobic_digestion.html
- ²¹¹ Balsam, John. "Anaerobic Digestion of Animal Wastes: Factors to Consider," *ATTRA*, Oct. 2002. <http://www.attra.ncat.org/attra-pub/PDF/anaerobic.pdf>
- ²¹² "2007 Census of Agriculture: Colorado State and County Data." *United States Department of Agriculture National Agricultural Statistics Service*. Table 11. December 2009. http://www.agcensus.usda.gov/Publications/2007/Full_Report/Volume_1,_Chapter_1_State_Level/Colorado/cov1.pdf.
- ²¹³ Schnepf, Randy. "CRS Report for Congress Agriculture-Based Renewable Energy Production:

RL32712." *Congressional Research Service*. January 4, 2005.
ncseonline.org/NLE/CRSreports/05Jan/RL32712.pdf

²¹⁴ "Managing Manure with Biogas Recovery Systems," *EPA, OAR*, EPA-430-F-02-004, Winter 2002.



3. Water Use

- ²¹⁵ Barnett, T.P., D.W. Pierce, H.G. Hidalgo, et al. "Human-induced changes in the hydrology of the western United States." *Science*, 319(5866), 1080-1083. 2008.
- ²¹⁶ Rauscher, S.A., J.S. Pal, N.S. Diffenbaugh, and M.M. Benedetti. "Future changes in snowmelt-driven runoff timing over the western United States." *Geophysical Research Letters*, 35, L16703, doi:10.1029/2008GL034424. 2008.
- ²¹⁷ Adams, R.M., B.A. McCarl, D.J. Dudek, and J.D. Glycer. "Implications of Global Climate Change for Western Agriculture." *Western Journal of Agricultural Economics*. Volume 13, Number 2 (1988), 351.
- ²¹⁸ "Colorado's Water Supply Future." *Statewide Water Supply Initiative. Colorado Water Conservation Board*. 26 January, 2011. <http://cwcb.state.co.us/water-management/water-supply-planning/Documents/SWSI2010/SWSI2010FactSheet.pdf>.
- ²¹⁹ Abler, D., R. Darwin, K. Fuglie, et al. "U.S. AGRICULTURE AND CLIMATE CHANGE: NEW RESULTS." *Kluwer Academic Publishers. Climatic Change* 57, 52. 2003. <http://0-www.springerlink.com.bianca.penlib.du.edu/content/r20612355852572p/fulltext.pdf>.
- ²²⁰ Barta, Rachel, I. Broner, J. Schneekloth and R. Waskom. "Colorado High Plains Irrigation Practices Guide: Water Saving Options for Irrigators in Eastern Colorado" Special Report No. 14. *Colorado Water Resources Research Institute*. 2004
- ²²¹ Gollehon, Noel. "Agriculture Dominates Freshwater Use in the U.S." *Amber Waves, USDA ERS*. 2006.
- ²²² "Soil Survey of Boulder County Area, Colorado." *United States Department of Agriculture. Natural Resources Conservation Service*. 110. <http://websoilsurvey.nrcs.usda.gov/app/HomePage.htm>. Accessed December, 2010.
- ²²³ Hall, M.D. "Relative sensitivity of Colorado groundwater to pesticide impact: Colorado Department of Agriculture, Groundwater Protection Program," Fact Sheet 16, p 7 1998.
- ²²⁴ "Soil Survey of Boulder County Area, Colorado." *United States Department of Agriculture. Natural Resources Conservation Service*. 110. <http://websoilsurvey.nrcs.usda.gov/app/HomePage.htm>. Accessed December, 2010.
- ²²⁵ "2007 Census of Agriculture: Colorado State and County Data." *United States Department of Agriculture National Agricultural Statistics Service*. Table 46. December 2009. http://www.agcensus.usda.gov/Publications/2007/Full_Report/Volume_1,_Chapter_1_State_Level/Colorado/cov1.pdf.
- ²²⁶ "Soil Survey of Boulder County Area, Colorado." *United States Department of Agriculture. Natural Resources Conservation Service*. 110. <http://websoilsurvey.nrcs.usda.gov/app/HomePage.htm>. Accessed December, 2010.
- ²²⁷ Brenner, John, J. Walker, C. Gustafson, et al. "Irrigation Guide." *USDA National Resources Conservation Service: National Engineering Handbook*. 1997. ftp://ftp-fc.sc.egov.usda.gov/OK/tech/Irrigation%20Guide/national_all.pdf
- ²²⁸ Al-Kaisi, M.M. and I. Broner. "Crop Water Use and Growth Stages." no. 4.715. *Colorado State University Extension*. 2009. <http://www.ext.colostate.edu/pubs/crops/04715.html>.
- ²²⁹ Brenner, John, J. Walker, C. Gustafson, et al. "Irrigation Guide." *USDA National Resources Conservation Service: National Engineering Handbook*. 1997. ftp://ftp-fc.sc.egov.usda.gov/OK/tech/Irrigation%20Guide/national_all.pdf
- ²³⁰ Ibid.
- ²³¹ Al-Kaisi, M.M. and I. Broner. "Crop Water Use and Growth Stages." no. 4.715. *Colorado State Sustainable Agriculture Literature Review*

- University Extension*. 2009. <http://www.ext.colostate.edu/pubs/crops/04715.html>.
- ²³² Brenner, John, J. Walker, C. Gustafson, et al. "Irrigation Guide." *USDA National Resources Conservation Service: National Engineering Handbook*. 1997. ftp://ftp-fc.sc.egov.usda.gov/OK/tech/Irrigation%20Guide/national_all.pdf
- ²³³ "2007 Census of Agriculture: Colorado State and County Data." *United States Department of Agriculture National Agricultural Statistics Service*. Table 46. [Selected Operation and Operator Characteristics: 2007 and 2002]. December 2009. http://www.agcensus.usda.gov/Publications/2007/Full_Report/Volume_1,_Chapter_1_State_Level/Colorado/cov1.pdf.
- ²³⁴ Barta, Rachel, I. Broner, J. Schneekloth, and R. Waskom. "Colorado High Plains Irrigation Practices Guide Water Saving Options for Irrigators in Eastern Colorado" Special Report No. 14. *Colorado Water Resources Research Institute*. Spring 2004
- ²³⁵ "2007 Census of Agriculture: Colorado State and County Data." *United States Department of Agriculture National Agricultural Statistics Service*. Table 46. [Selected Operation and Operator Characteristics: 2007 and 2002]. December 2009. http://www.agcensus.usda.gov/Publications/2007/Full_Report/Volume_1,_Chapter_1_State_Level/Colorado/cov1.pdf.
- ²³⁶ Yonts, C. D. "Technical Considerations of Converting from Surface Irrigation." Proceedings of Central Plains Irrigation Short Course and Exposition. February 5-6, 2002, Lamar, Colorado. *Central Plains Irrigation Association*, Colby, Kansas. pp. 149-151. 2002.
- ²³⁷ Howell, T.A. "Irrigation System Efficiencies." Proceedings of Central Plains Irrigation Short Course and Exposition. February 5-6, 2002, Lamar, Colorado. *Central Plains Irrigation Association*, Colby, Kansas. pp. 80-92. 2002.
- ²³⁸ Barta, Rachel, I. Broner, J. Schneekloth, and R. Waskom. "Colorado High Plains Irrigation Practices Guide Water Saving Options for Irrigators in Eastern Colorado" Special Report No. 14. *Colorado Water Resources Research Institute*. Spring 2004
- ²³⁹ Lamm, F.R. "Corn production as related to sprinkler irrigation capacity." *Proceedings of the Central Plains Irrigation Conference*, Kearney, Nebraska. 2004.
- ²⁴⁰ Lamm, F.R. and T.P. Trooien. "Irrigation capacity and plant population effects on corn production using SDI." *Proceedings of 2001 Irrigation Association International Technical Conference and Exposition*, Nov. 4-6, 2001, San Antonio, Texas. Pages 73-80. 2001.
- ²⁴¹ Schneekloth, J.P., N.L. Klocke, G.W. Hergert, D.L. Martin, and R.T. Clark. "Crop rotations with full and limited irrigation and dryland management." *Trans. of the ASAE*. 34(6): 2372-2380. 1991.
- ²⁴² Schneekloth, J., T. Bauder, and N. Hansen. "Limited Irrigation Management: no. 4.720 Principles and Practices." *Irrigation* © Colorado State University Extension. 2009. <http://www.ext.colostate.edu/pubs/crops/04720.html>
- ²⁴³ Schneekloth, J. and Andales, A. "Seasonal Water Needs and Opportunities for Limited Irrigation for Colorado Crops." Colorado State University Extension. September, 2009. <http://www.ext.colostate.edu/pubs/crops/04718.html>
- ²⁴⁴ Ibid.
- ²⁴⁵ Ibid.
- ²⁴⁶ Trimmer, W. and H. Hansen. "Irrigation Scheduling." 1994. <http://ir.library.oregonstate.edu/jspui/bitstream/1957/15998/1/pnw288.pdf>
- ²⁴⁷ Hanson, Blaine, Douglas Peters, and Steve Orloff. "Effectiveness of tensionmeters and electrical resistance sensors varies with soil conditions." *California Agriculture*. Vol. 54. No 3. May-June 2000. 47-50. ucanr.org/sites/kingscounty/files/19213.pdf

- ²⁴⁸ Trimmer, W. and H. Hansen. "Irrigation Scheduling." 1994.
<http://ir.library.oregonstate.edu/jspui/bitstream/1957/15998/1/pnw288.pdf>
- ²⁴⁹ Ibid.
- ²⁵⁰ Ibid.
- ²⁵¹ Broner, I. "Irrigation Scheduling: The Water Balance Approach." *Colorado State University Extension*. 12 May, 2010. <http://www.ext.colostate.edu/pubs/crops/04707.html>.
- ²⁵² Ibid.
- ²⁵³ Enciso, Juan M., Dana Porter, and Xavier Périès. "Irrigation Monitoring with Soil Water Sensors." *Texas Cooperative Extension. The Texas A&M University System*. January, 2007. www.extension.org/mediawiki/files/d/db/SoilWaterSensors.pdf.
- ²⁵⁴ Trimmer, W. and H. Hansen. "Irrigation Scheduling." 1994.
<http://ir.library.oregonstate.edu/jspui/bitstream/1957/15998/1/pnw288.pdf>
- ²⁵⁵ Brenner, John, J. Walker, C. Gustafson, et al. "Irrigation Guide." *USDA National Resources Conservation Service: National Engineering Handbook*. 1997. ftp://ftp-fc.sc.egov.usda.gov/OK/tech/Irrigation%20Guide/national_all.pdf
- ²⁵⁶ "Soil Quality Resource Concerns: Compaction." *USDA Natural Resources Conservation Service*. April 1996. soils.usda.gov/sqi/publications/files/sq_nin_1.pdf.
- ²⁵⁷ Ibid.
- ²⁵⁸ Ibid.
- ²⁵⁹ "Soil Quality Management." *National Resources Conservation Services*.
<http://soils.usda.gov/sqi/management/management.html>.
- ²⁶⁰ Ibid.
- ²⁶¹ "Soil." *European Commission*. http://ec.europa.eu/agriculture/organic/environment/soil_en
- ²⁶² "Using Subsoiling To Reduce Soil Compaction." *United States Department of Agriculture Forest Service*. July 2008. <http://www.fs.fed.us/t-d/pubs/pdfpubs/pdf08342828/pdf08342828dpi72.pdf>.
- ²⁶³ Raper, R. L., D. W. Reeves, E. B. Schwab, & C. H. Burmester. "Reducing soil compaction of Tennessee Valley soils in conservation tillage systems." *Journal of Cotton Science*. 4 (2): 84-90. 2000.
- ²⁶⁴ J.G. Benjamin, H.G. & M.M. Mikha. "Land Degradation and Desertification: Assessment, Mitigation and Remediation." DOI: 10.1007/978-90-481-8657-0_49. Part 5: 649-656. 2010.
- ²⁶⁵ Ibid.
- ²⁶⁶ Ibid.
- ²⁶⁷ Ishaq, M. & M. Ibrahim ed. R. Lal. "Compaction and Crop Yield." *Encyclopedia of soil science, Volume 1* (Boca Raton, FL: CRC Press, 2006), 310.
- ²⁶⁸ Cahoon, J., N. Klocke, W. Kranz. "Crop Residue and Irrigation Water Management. University of Nebraska Lincoln Cooperative Extension." Institute of Agriculture and Natural Resources. 1993. www.ianr.unl.edu/pubs/irrigation/g1154.htm.
- ²⁶⁹ Bauder, T., R. Waskom, J. Schneekloth, J. Alldredge. "Best Management Practices for Colorado Corn." *Colorado State University Cooperative Extension*. Colorado State University, Fort Collins, Colorado. 2003.

-
- ²⁷⁰ “Conservation Practices that Save: Crop Residue Management.” *U.S. Department of Agriculture (USDA) Natural Resource Conservation Service*. 2010. <http://www.nrcs.usda.gov/TECHNICAL/energy/cropres.html>
- ²⁷¹ “Annual Report.” *U.S. Department of Agriculture (USDA)*. 2007. http://www.ars.usda.gov/research/programs/programs.htm?np_code=216&docid=16490
- ²⁷² Lilly, J.P. “Soil Facts – Best Management Practices for Agricultural Methods.” *Publication of North Carolina State University*. 1997. <http://www.soil.ncsu.edu/publications/Soilfacts/AG-439-20/>
- ²⁷³ Brouwer, C., K. Prins, M. Kay, M. Heibloem. “Irrigation Water Management: Irrigation Methods. Training Manual No. 5.” *Food and Agriculture Organization of the United Nations*. Rome, Italy. <http://www.fao.org/docrep/s8684e/s8684e00.htm#Contents>.
- ²⁷⁴ Ho, Mae-Wan, and L. L. Ching. “Mitigating Climate Change through Organic Agriculture and Localized Food Systems.” *Institute of Science and Society*. 31 January 2008. <http://www.issis.org.uk/mitigatingClimateChange.php>.

4. Water Pollution

- ²⁷⁵ Eisenhauer, D.E. and Bjorneberg, D. and Westermann, D. (2006) *Water management practices: Irrigated Cropland*. In: Schnepf, M. and Cox, C. (eds.) *Environmental Benefits of Conservation on Cropland: The Status of Our Knowledge* (1st Edition). pp. 131-148. Soil and Water Conservation Society, Ankeny, IA.
- ²⁷⁶ Fernald, A.G., Baker, T.T., and Guldan, S.J. "Hydrologic, Riparian, and Agroecosystem Functions of Traditional *Acequia* Irrigation Systems." *Journal of Sustainable Agriculture*, Vol. 30(2) 2007
- ²⁷⁷ Doorenbos, J. and W.O. Pruitt. 1992. *Crop Water Requirements*. FAO Irrigation and Drainage Paper No. 24. Food and Agriculture Organization of the United Nations. <http://www.fao.org/docrep/x0490e01.htm>
- ²⁷⁸ Harvey, F.E. and S.S. Sibray. 2001. Delineating ground water recharge from leaking irrigation canals using water chemistry and isotopes. *Ground Water* 39(3):408-421.
- ²⁷⁹ Brenner, John, J. Walker, C. Gustafson, et al. "Irrigation Guide." *USDA National Resources Conservation Service: National Engineering Handbook*. 1997. ftp://ftp-fc.sc.gov.usda.gov/OK/tech/Irrigation%20Guide/national_all.pdf
- ²⁸⁰ "Irrigation Ditch Lining, Code 428." Natural Resources Conservation Service – Conservation Practice Standard. September 2010.
- ²⁸¹ FAO. "Control of Water Pollution by Agriculture: Chapter 2. Pollution by Sediments." *FAO Corporate Document Repository*. 2011. <http://www.fao.org/docrep/w2598e/w2598e05.htm>
- ²⁸² "Soil and Water Quality: An Agenda for Agriculture." *Committee on Long-Range Soil and Water Conservation, Board of Agriculture, National Research Council*. National Academy Press, Washington, D.C. 1993.
- ²⁸³ "National Water Quality Inventory: Report to Congress 1992." *US-EPA*. EPA-841-R-94-001. Office of Water, Washington, DC. 1994.
- ²⁸⁴ "Control of Water Pollution by Agriculture: Chapter 2. Pollution by Sediments." *FAO Corporate Document Repository*. 2011. <http://www.fao.org/docrep/w2598e/w2598e05.htm>
- ²⁸⁵ "Introduction to Agricultural Water Pollution: Chapter 1. Pollution by Sediments." *FAO Corporate Document Repository*. 2011. <http://www.fao.org/docrep/w2598e/w2598e04.htm#irrigation%20impacts%20on%20surface%20water%20quality>
- ²⁸⁶ "National Water Quality Inventory: Report to Congress 1992." *US-EPA*. EPA-841-R-94-001. Office of Water, Washington, DC. 1994.
- ²⁸⁷ Barber, Larry B. "Chemical Loading into Surface Water along a Hydrological, Biogeochemical, and Land Use Gradient: A Holistic Watershed Approach" *Environmental Science and Technology*. 2006. Vol. 40 (2) pp. 475-48
- ²⁸⁸ US Geol. Surv. (USGS). 1999. "The quality of our nation's waters—nutrients and pesticides." *USGS Circular 1225*
- ²⁸⁹ LeVeen EP, WilleyWRZ.1983. "A political economic analysis of urban pest management." Frankie & Kohler 1983, pp. 19–40
- ²⁹⁰ Paul, Micheal J. "Streams in the Urban Landscape." *Annu. Rev. Ecol. Syst.* 2001. 32:333-365
- ²⁹¹ Hoffman RS, Capel PD, Larson SJ. 2000. "Comparison of pesticides in eight U.S. urban streams." *Env. Toxicol. Chem.* 19:2249–58
- ²⁹² US Geol. Surv. (USGS). 1999. "The quality of our nation's waters—nutrients and pesticides." *USGS Circular 1225*



- ²⁹³ Roose, E. "Introduction à la gestion conservatoire de l'eau, de la biomasse et de la fertilité des sols (GCES)." *Bulletin Pédologique de la FAO* No. 70. FAO, Rome. 1994.
- ²⁹⁴ Ibid.
- ²⁹⁵ "Control of Water Pollution by Agriculture: Chapter 2. Pollution by Sediments." *FAO Corporate Document Repository*. 2011. <http://www.fao.org/docrep/w2598e/w2598e05.htm>.
- ²⁹⁶ Ibid.
- ²⁹⁷ Cid, Nuria, Carles Ibanez, Albert Palanquez, Narcis Prat "Patterns of metal bioaccumulation in two filter-feeding macroinvertebrates: Exposure distribution, inter-species differences and variability across developmental stages" *Science of The Total Environment* Volume 408, Issue 14, 15 June 2010, Pages 2795-2806
- ²⁹⁸ Burger, Joanna, Karen F. Gaines, C, Shane Boring, et al. "Mercury and Selenium in Fish from the Savannah River: Species, Trophic Level, and Locational Differences" *Environmental Research* Volume 87, Issue 2, October 2001, Pages 108-118
- ²⁹⁹ Bioaccumulation of selenium in birds at Kesterson Reservoir, California" *Archives of Environmental Contamination and Toxicology* Volume 19, Number 4, 495-507, DOI: 10.1007/BF01059067
- ³⁰⁰ Vitousek, P.M., J.D. Aber, R.W. Howarth, et al. "Human alteration of the global nitrogen cycle: sources and consequences." *Ecol. Appl.* P 7, 737–750. 1997.
- ³⁰¹ Schonbeck, Mark. "Ecologically Sound Nitrogen Management: One Researcher's Educated Guess." *Online article for the Northeast Organic Farming Association*. February 2004. <http://www.nofa.org/tnf/nitrogen.php>
- ³⁰² Ibid.
- ³⁰³ Ibid.
- ³⁰⁴ "Agricultural Chemicals and Groundwater Protection in Colorado 1990-2006." Colorado Water Resources Water Resources Research Institute. Special Report No. 16. *Colorado Department of Agriculture, Colorado State University Extension, Colorado Department of Public Health and Environment*. www.cwi.colostate.edu/publications/sr/16.pdf
- ³⁰⁵ Bauder, Troy Allen. "Agricultural Chemicals and Groundwater Protection in Colorado 1990-2006." Colorado Dept. of Agriculture, Colorado Dept. of Public Health and Environment, Water Quality Control Division, and Colorado State University, Cooperative Extension. Special Report no. 16. 54 p. 2008.
- ³⁰⁶ "National Primary Drinking Water Regulations: Drinking Water Contaminations." *Environmental Protection Agency*. January 2011. <http://water.epa.gov/drink/contaminants/index.cfm#1>
- ³⁰⁷ Kross, B.C., G.R Hallberg, D.R. Bruner, K. Cherryholmes, and J.K. Johnson. "The Nitrate Contamination of Private Well Water in Iowa." *Am. J. Public Health*. 83: 270-272. 1993.
- ³⁰⁸ Bruning-Fann, C.S. and J.B. Kaneene. "The effects of nitrate, nitrite, and N-nitroso compounds on human health: a review." *Vet Human Toxicology* 35: 521-538. 1993.
- ³⁰⁹ Lilly, J.P. "Soil Facts – Best Management Practices for Agricultural Methods." *Publication of North Carolina State University*. 1997. <http://www.soil.ncsu.edu/publications/Soilfacts/AG-439-20/>
- ³¹⁰ "Eutrophication Definitions." *U.S. Geological Survey (USGS)*. 2010. <http://toxics.usgs.gov/definitions/eutrophication.html>
- ³¹¹ Cloern, James E., T. Krantz, and C. M. Hogan PhD. "Eutrophication." *The Encyclopedia of the Earth*. 2010. <http://www.eoearth.org/article/Eutrophication>
- ³¹² Ibid.
- ³¹³ Gelder, Brian, J. Loftis, M. Koski, B. Johnson, and L. Saito. "Eutrophication of Reservoirs on the

- Colorado Front Range." *Colorado Water Resources Research Institute*. 2003. www.cwi.colostate.edu/publications/cr/194.pdf
- ³¹⁴ "Disinfection Byproducts: A Reference Resource." *Environmental Protection Agency*. November 2010. http://www.epa.gov/envirofw/html/icr/gloss_dbp.html.
- ³¹⁵ Ibid.
- ³¹⁶ Ibid.
- ³¹⁷ Waskom, R.M. and B. Bauder. "Best Management Practices for Phosphorus Fertilization" *Colorado State University Extension, Colorado Department of Agriculture and the Agricultural Chemicals and Groundwater Protection Advisory Committee*.
- ³¹⁸ "Agricultural Chemicals and Groundwater Protection in Colorado 1990-2006." Colorado Water Resources Water Resources Research Institute. Special Report No. 16. *Colorado Department of Agriculture, Colorado State University Extension, Colorado Department of Public Health and Environment*. www.cwi.colostate.edu/publications/sr/16.pdf
- ³¹⁹ Dennehy, K.F., D.W. Litke, C.M. Tate, et al. "Water quality in the South Platte River Basin, Colorado, Nebraska, and Wyoming." 1992–95: *U.S. Geological Survey Circular 1167*, 38 p. 1998.
- ³²⁰ Ibid.
- ³²¹ Rupert, M. "Probability of Detecting Atrazine/Desethyl-atrazine and Elevated Concentrations of Nitrate in Ground Water in Colorado." Water-Resources Investigations Report 02–4269. *U.S. Geological Survey in cooperation with the Colorado Department of Agriculture, Colorado Department of Public Health and Environment, and Colorado State University Cooperative Extension*. Denver, Colorado. 2003.
- ³²² "The quality of our Nation's waters—Nutrients and pesticides: U.S. Geological Survey Circular 1225." *U.S. Geological Survey*. p 82. 1999. <http://water.usgs.gov/pubs/circ/circ1225/index.html>.
- ³²³ "Pesticide Information Profile: Glyphosate." *Extension Toxicology Network*. Pesticide Information Project of Cooperative Extension Offices of Cornell University, Michigan State University, Oregon State University, and University of California at Davis. May 1994.
- ³²⁴ Forest Service (1984). Pesticide Background Statements, Vol. I Herbicides. United States Dept. of Agriculture, Agriculture Handbook No. 633.
- ³²⁵ "Pesticide Information Profile: Glyphosate." *Extension Toxicology Network*. Pesticide Information Project of Cooperative Extension Offices of Cornell University, Michigan State University, Oregon State University, and University of California at Davis. May 1994.
- ³²⁶ "Agricultural Chemicals and Groundwater Protection in Colorado 1990-2006." Colorado Water Resources Water Resources Research Institute. Special Report No. 16. *Colorado Department of Agriculture, Colorado State University Extension, Colorado Department of Public Health and Environment*. www.cwi.colostate.edu/publications/sr/16.pdf
- ³²⁷ Kimbrough, R. and D.W. Litke. "Pesticides in Streams Draining Agricultural and Urban Areas in Colorado." *Environ. Sci. Technol.* 30: 908-916 *U.S. Geological Survey*. 1996.
- ³²⁸ "Bioconcentration Definitions." *U.S. Geological Survey (USGS)*. 2010. <http://toxics.usgs.gov/definitions/bioconcentration.html>.
- ³²⁹ "Agricultural Chemicals and Groundwater Protection in Colorado 1990-2006." Colorado Water Resources Water Resources Research Institute. Special Report No. 16. *Colorado Department of Agriculture, Colorado State University Extension, Colorado Department of Public Health and Environment*. www.cwi.colostate.edu/publications/sr/16.pdf
- ³³⁰ Ibid.



5. Soil Health

- ³³¹ Dorana, John W. and M. R. Zeiss. "Soil health and sustainability: managing the biotic component of soil quality." *Applied Soil Ecology* 15: p 3–11. 2000.
- ³³² M.R. Carter, E.G. Gregorich, D.W. Anderson, et al. "Concepts of Soil Quality and Their Significance" *Developments in Soil Science*. Soil Quality for Crop Production and Ecosystem Health. pg. 1-20. 2007
- ³³³ North Boulder Valley Inventory Report. City of Boulder Open Space Department. May 30, 1997.
- ³³⁴ "Boulder county Web Soil Survey." *Natural Resources Conservation Service. United States Department of Agriculture*. Accessed January 6, 2011.
- ³³⁵ Saunders, D.W. "International activities in assessing and monitoring soil degradation (Special Issue on Soil Quality)." *Am. J. Alter. Agric.* p 7, pp 17–24. 1992.
- ³³⁶ Oldeman, L.R. "The global extent of soil degradation." *Applied Soil Ecology* 15 (2000) 3–11.
- ³³⁷ "Sustainable Land Use." *CAB International*, Wallingford, Oxon, UK, pp. 99–118. 1994.
- ³³⁸ Houghton, R.A., J.E. Hobbie, J.M. Melillo, et al. "Changes in the carbon content of terrestrial biota and soils between 1860 and 1980: a net release of CO₂ to the atmosphere." *Ecol. Monog.* 53: 235–262. 1983.
- ³³⁹ Romig, D.E., M.J. Garlynd, R.F. Harris. "Farmer-based assessment of soil quality: A soil health scorecard." *Methods for Assessing Soil Quality. Soil Science Society of America, Special Publication 49*: Madison, WI, pp. 39–60. 1996.
- ³⁴⁰ "Farming in the 21st Century a Practical Approach to Improve Soil." Soil Quality National Technology Development Team. *United States Department of Agriculture –Natural Resources Conservation Service*. September 2010.
- ³⁴¹ Ibid.
- ³⁴² Montgomery, David R. "Soil erosion and agricultural sustainability." *Department of Earth and Space Sciences*, University of Washington. 2007.
- ³⁴³ "Soil, Water, and Related Resources in the United States: Status, Conditions and Trends." *US Department of Agriculture*. Washington, DC. 1980.
- ³⁴⁴ Selby, M.J. *Hillslope Materials and Processes*. Oxford University Press, Oxford. 1993.
- ³⁴⁵ Ursic, S.J. and F. E. Dendy. (1965) in *Proceedings of the Federal Inter-Agency Sedimentation Conference, 1963* (US Department of Agriculture, Washington, DC), pp 47–52.
- ³⁴⁶ Hooke RL "On the history of humans as geomorphic agents." *Geology*, 28: 843–846. 2000.
- ³⁴⁷ "World in Transition: The Threat to Soils. Annual Report." *German Advisory Council on Global Change. Bonn, Economica Verlag GmbH*. 1994.
- ³⁴⁸ "Web Soil Survey: Intro to Soils." *United States Department of Agriculture. Natural Resources Conservation Service*. 1999. <http://websoilsurvey.nrcs.usda.gov/app/WebSoilSurvey.aspx>.
- ³⁴⁹ Montgomery, David R. "Soil erosion and agricultural sustainability." *Department of Earth and Space Sciences*, University of Washington. 2007.
- ³⁵⁰ Pimentel, D., C. Harvey, P. Resosudarmo, et al. "Environmental and economic costs of soil erosion and conservation benefits." *Science*. Vol. 267, No. 5201. p. 1117-1123. 1995.
- ³⁵¹ Ibid.

- ³⁵² Troeh, F.R., J.A. Hobbs, R.L. Donahue et al. *Soil and Water Conservation*. Prentice- Hall, Englewood Cliffs, NJ. 1991.
- ³⁵³ "Web Soil Survey: Intro to Soils." *United States Department of Agriculture. Natural Resources Conservation Service*. 1999. <http://websoilsurvey.nrcs.usda.gov/app/WebSoilSurvey.aspx>.
- ³⁵⁴ "Boulder County Web Soil Survey." *Natural Resources Conservation Service United States Department of Agriculture*. Accessed January 6, 2011.
- ³⁵⁵ "North Boulder Valley Inventory Report." *City of Boulder Open Space Department*. May 30, 1997
- ³⁵⁶ "Impact of Genetically Engineered Crops on Farm Sustainability in the United States." *National Research Council, The National Academies Press*. p 63. 2010. http://www.nap.edu/catalog.php?record_id=12804
- ³⁵⁷ "2008 Amendment to the National Crop Residue Management Survey Summary. National Crop Residue Management Survey." *Conservation Technology Information Center*. [http://www.ctic.purdue.edu/media/pdf/National%20Summary%202008%20\(Amendment\).pdf](http://www.ctic.purdue.edu/media/pdf/National%20Summary%202008%20(Amendment).pdf)
- ³⁵⁸ Ebel, Robert, J. Horowitz, and K. Ueda. "No-Till' Farming Is a Growing Practice." *United States Department of Agriculture. Economic Research Service*. November 2010. <http://www.ers.usda.gov/Publications/EIB70/EIB70.pdf>.
- ³⁵⁹ Kuepper, George. "Pursuing Conservation Tillage Systems for Organic Crop Production." *NCAT/ATTRA National Sustainable Agriculture Information Service*. June 2001. <http://attra.ncat.org/attra-pub/organicmatters/conservationtillage.html>
- ³⁶⁰ Benjamin, J. G., H. Blanco-Canqui, D. J. Lyon, et al. "Regional Study of No-Till Impacts on Near-Surface Aggregate Properties that Influence Soil Erodibility." *Soil Science Society of America Journal* 73, no 4 (2009): 1361-1368.
- ³⁶¹ Ebel, Robert, J. Horowitz, and K. Ueda. "No-Till' Farming Is a Growing Practice." *United States Department of Agriculture. Economic Research Service*. November 2010. <http://www.ers.usda.gov/Publications/EIB70/EIB70.pdf>.
- ³⁶² Sullivan, Preston. "Sustainable Soil Management." *The National Sustainable Agriculture Information Service*. 2004. <http://attra.ncat.org/attra-pub/soilmgmt.html#tillage>.
- ³⁶³ Halvorson, Ardell D. and C. A. Reule. "Irrigated Corn and Soybean Response to Nitrogen under No-Till in Northern Colorado." *Agronomy Journal* 98, 1367–1374. 2008. <http://ddr.nal.usda.gov/dspace/bitstream/10113/3625/1/IND43855549.pdf>.
- ³⁶⁴ "Conservation Practices that Save: Crop Residue Management." *U.S. Department of Agriculture (USDA) Natural Resource Conservation Service*. <http://www.nrcs.usda.gov/TECHNICAL/energy/cropres.html>
- ³⁶⁵ "Agricultural System Competitiveness and Sustainability: 2007 Annual Report." *U.S. Department of Agriculture (USDA) Agricultural Research Service*. 2007. http://www.ars.usda.gov/research/programs/programs.htm?np_code=216&docid=16490
- ³⁶⁶ Archer, David W., A. D. Halvorson, and C. A. Reule. "Economics of Irrigated Continuous Corn under Conventional-Till and No-Till in Northern Colorado." *Agronomy Journal* 100(4): 1166-1172. 2008. <http://ddr.nal.usda.gov/dspace/bitstream/10113/18247/1/IND44074233.pdf>.
- ³⁶⁷ Berrada, Abdel. "Developing Sustainable Dryland Cropping Systems in SW Colorado and SE Utah Using Conservation Tillage and Crop Diversification." *Colorado State University: Agricultural Experiment Station*. September 2004. http://library.du.edu/clickthrough/index.php/clicks/?type=cou&url=http://hdl.handle.net/10176/co:6281_ucs20210tb042internet.pdf.
- ³⁶⁸ Peigné, J., B.C. Ball, J. Roger-Estrade, and C. David. "Is conservation tillage suitable for organic farming?" *Soil Use and Management* 23:129-144. 2007.

- ³⁶⁹ Blevins, R.L., and W.W. Frye. "Conservation tillage: an ecological approach to soil management." *Advances in Agronomy* 51:33-77. 1993.
- ³⁷⁰ Morse, R.D. "No-till vegetable production – its time is now." *HortTechnology* 9(3):373-379. 1999.
- ³⁷¹ Peigné, J., B.C. Ball, J. Roger-Estrade, and C. David. "Is conservation tillage suitable for organic farming?" *Soil Use and Management* 23:129-144. 2007.
- ³⁷² "Strip tillage write-up." National Resource Conservation Service (NRCS). *Direct Correspondence Boyd Byelich. USDA-NRCS, Longmont F.O.* March 2011.
- ³⁷³ McGinnis, Laura. "Show Me the Money: Why Economics Is Essential for Sustainable Agriculture." *United States Department of Agriculture*. 30 July 2007. <http://www.ars.usda.gov/is/AR/archive/jul07/money0707.htm>. Note: Figures adapted from David Archer's findings.
- ³⁷⁴ Ibid.
- ³⁷⁵ Archer, David W., A. D. Halvorson, and C. A. Reule. "Economics of Irrigated Continuous Corn under Conventional-Till and No-Till in Northern Colorado." *Agronomy Journal* 100(4): 1166-1172. 2008. <http://ddr.nal.usda.gov/dspace/bitstream/10113/18247/1/IND44074233.pdf>.
- ³⁷⁶ McGinnis, Laura. "Show Me the Money: Why Economics Is Essential for Sustainable Agriculture." *United States Department of Agriculture*. 30 July 2007. <http://www.ars.usda.gov/is/AR/archive/jul07/money0707.htm>. Note: Figures adapted from David Archer's findings.
- ³⁷⁷ Kuepper, George. "Pursuing Conservation Tillage Systems for Organic Crop Production." *NCAT/ATTRA National Sustainable Agriculture Information Service*. June 2001. <http://attra.ncat.org/attra-pub/organicmatters/conservationtillage.html>
- ³⁷⁸ "Tillage Practice Guide." *United States Department of Agriculture: Natural Resources Conservation Service*. 2006. <http://www.mn.nrcs.usda.gov/technical/ecs/agron/Tillage%2520Practice%2520Guide.pdf>
- ³⁷⁹ Ascough II, J., D. Hoag, and J. Popp. "Targeting soil-conservation policies for sustainability: New empirical evidence." *Journal of Soil and Water Conservation* 57(2): 66-74. March/April 2002. <http://0-proquest.umi.com/bianca.penlib.du.edu/pqdweb?index=0&did=132746331&SrchMode=1&sid=1&Fmt=6&VInst=PROD&VType=PQD&RQT=309&VName=PQD&TS=1291922754&clientId=48347>.
- ³⁸⁰ "Soil Survey of Boulder County Area, Colorado." *United States Department of Agriculture. Natural Resources Conservation Service*. 110. <http://websoilsurvey.nrcs.usda.gov/app/HomePage.htm>. Accessed December, 2010.
- ³⁸¹ Ibid.
- ³⁸² Trlica, M.J. "Grass Growth and Response to Grazing." *Colorado State University Extension*. 10 May, 2010. <http://www.ext.colostate.edu/pubs/natres/06108.html>.
- ³⁸³ Ibid.
- ³⁸⁴ Rauzi, Frank, and F. M. Smith. "Infiltration Rates: Three Soils with Three Grazing Levels in Northeastern." *Journal of Range Management*, 26(2): 126-129. March 1973. <http://www.jstor.org/stable/3896467>.
- ³⁸⁵ "Soil Survey of Boulder County Area, Colorado." *United States Department of Agriculture. Natural Resources Conservation Service*. 110. <http://websoilsurvey.nrcs.usda.gov/app/HomePage.htm>. Accessed December, 2010.

- ³⁸⁶ “Conservation Crop Rotation.” *United States Department of Agriculture. Natural Resources Conservation Service*. August, 2008. http://www.nrcs.usda.gov/programs/Env_Assess/ndocs/cons_crop_rotation_328_2008.doc.
- ³⁸⁷ Welsh, Dr. Douglas F. “Horticulture Updat.” *Texas A&M University System*, College Station, Texas. July/August 2001. <http://aggie-horticulture.tamu.edu/extension/newsletters/hortupdate/julaug01/art3jul.html>.
- ³⁸⁸ K.A. Barbarick and D.G. Westfall. “Biosolids Recycling.” no. 0.547. *Colorado State University Extension*. January 2007. <http://www.ext.colostate.edu/pubs/crops/00547.html>
- ³⁸⁹ Sullivan, Preston. “Overview of Cover Crops and Green Manures. Fundamentals of Sustainable agriculture.” ATTRA National Sustainable Agriculture Information Service. July 2003.
- ³⁹⁰ Frye, W.W., and R.L. Blevins. “Economically sustainable crop production with legume cover crops and conservation tillage.” *Journal of Soil and Water Conservation*. Volume 44, Number 1. p. 57-60. 1989.
- ³⁹¹ “Farming in the 21st Century a Practical Approach to Improve Soil.” Soil Quality National Technology Development Team. *United States Department of Agriculture Natural Resources Conservation Service*. September 2010.
- ³⁹² Clark, Andy. “Managing Cover Crops Profitably.” 3rd Edition. *Sustainable Agriculture Network*. 2007 [Funding by the Sustainable Agriculture Research and Education Program of CSREES, U.S. Department of Agriculture]. www.sare.org/publications/covercrops/covercrops.pdf.
- ³⁹³ Snapp, S. S., S. M. Swinton, R. Labarta, D. Mutch, et al. “Evaluating Cover Crops for Benefits, Costs and Performance within Cropping System Niches.” *Agronomy Journal* 97: 322–332. 2005. <http://www.kbs.msu.edu/images/stories/docs/snapp/evaluatingcovercropsforbenefitscostsandperformancewithincroppingsystemniches.pdf>.
- ³⁹⁴ Clark, Andy. “Managing Cover Crops Profitably.” 3rd Edition. *Sustainable Agriculture Network*. 2007 [Funding by the Sustainable Agriculture Research and Education Program of CSREES, U.S. Department of Agriculture]. www.sare.org/publications/covercrops/covercrops.pdf.
- ³⁹⁵ Koch, Bradley, and Rajiv Khosla. “The Role of Precision Agriculture in Cropping Systems.” *Journal of Crop Production* 9, no. 1/2: 361-381. 2003. classes.css.wsu.edu/css403/8_PrecisionAg.pdf.
- ³⁹⁶ Rosen, Carl J. and Peter M. Bierman. “Maintaining Soil Fertility in an Organic Fruit and Vegetable Crops System.” 2005. <http://www.extension.umn.edu/distribution/horticulture/M1191.html>
- ³⁹⁷ Unger, P.W. and M.F. Vigil. “Cover crops effects on soil water relationships.” *J. Soil Water Cons.* 53:241–244. 1998.
- ³⁹⁸ Ibid.
- ³⁹⁹ Ibid.
- ⁴⁰⁰ Sullivan, Preston. “Overview of Cover Crops and Green Manures.” 2003. <http://attra.ncat.org/attra-pub/covercrop.html>.
- ⁴⁰¹ Ibid.
- ⁴⁰² Snapp, S. S., S. M. Swinton, R. Labarta, D. Mutch, et al. “Evaluating Cover Crops for Benefits, Costs and Performance within Cropping System Niches.” *Agronomy Journal* 97: 322–332. 2005. <http://www.kbs.msu.edu/images/stories/docs/snapp/evaluatingcovercropsforbenefitscostsandperformancewithincroppingsystemniches.pdf>.
- ⁴⁰³ Dabney, S. “Cover crop integration into conservation production systems.” SARE Project Report #LS96-073. *Southern Region SARE*. Griffin, Ga. 1996. www.sare.org/projects
- ⁴⁰⁴ Tillman, G. et al. “Influence of cover crops on insect pests and predators in conservation tillage cotton.” *Journal of Economic Entomology* 97:1217-1232. 2004.

- ⁴⁰⁵ Clark, Andy. "Managing Cover Crops Profitably." 3rd Edition. *Sustainable Agriculture Network*. 2007 [Funding by the Sustainable Agriculture Research and Education Program of CSREES, U.S. Department of Agriculture]. www.sare.org/publications/covercrops/covercrops.pdf.
- ⁴⁰⁶ Snapp, S. S., S. M. Swinton, R. Labarta, D. Mutch, et al. "Evaluating Cover Crops for Benefits, Costs and Performance within Cropping System Niches." *Agronomy Journal* 97: 322–332. 2005. <http://www.kbs.msu.edu/images/stories/docs/snapp/evaluatingcovercropsforbenefitscostsandperformancewithincroppingsystemniches.pdf>.
- ⁴⁰⁷ Halvorson, A.D. et al. "Nitrogen and tillage effects on irrigated continuous corn yields." *Journal of Agronomy*. 98:63–71. 2006.
- ⁴⁰⁸ Halvorson, A.D. and C.A.Reule. "Irrigated corn and soybean response to nitrogen under no-till in northern Colorado." *Journal of Agronomy*. 98:1367–1374. 2006.
- ⁴⁰⁹ Sullivan, Preston. "Overview of Cover Crops and Green Manures." *ATTRA National Sustainability Agriculture Information Service*. 2003. <http://attra.ncat.org/attra-pub/covercrop.html#cover>.
- ⁴¹⁰ Ibid.
- ⁴¹¹ Clark, Andy. "Managing Cover Crops Profitably." 3rd Edition. *Sustainable Agriculture Network*. 2007 [Funding by the Sustainable Agriculture Research and Education Program of CSREES, U.S. Department of Agriculture]. www.sare.org/publications/covercrops/covercrops.pdf.
- ⁴¹² Ibid.
- ⁴¹³ "Cover Crops." *Colorado State University Extension*. Planttalk Colorado. 28 October 2010. <http://www.ext.colostate.edu/ptlk/1616.html>
- ⁴¹⁴ Schonbeck, Mark. "Ecologically Sound Nitrogen Management: One Researcher's Educated Guess." Online article for the *Northeast Organic Farming Association*. 5 February 2004. <http://www.nofa.org/tnf/nitrogen.php>
- ⁴¹⁵ Sullivan, Preston. "Overview of Cover Crops and Green Manures." *ATTRA National Sustainability Agriculture Information Service*. 2003. <http://attra.ncat.org/attra-pub/covercrop.html#cover>.
- ⁴¹⁶ McDonald, Sandra K, Ed., Lindsay Hofsteen, and Lisa Downey. "Crop Profile for Alfalfa in Colorado." *Colorado State University Extension*. *Colorado Environmental and Pesticide Education Program*. September 2003. www.ipmcenters.org/cropprofiles/docs/coalfalfa.pdf.
- ⁴¹⁷ Carr, Patrick M. "Crop Rotation Benefits Of Annual Forages." *North Dakota State University Dickinson Research Extension*. 2006 Annual Report. <http://www.ag.ndsu.nodak.edu/dickinso/research/2005/agron05f.htm>.
- ⁴¹⁸ Erker, B. and M.A. Brick. "Legume Seed Inoculants." *Colorado State University Extension*. 10 May 2010. <http://www.ext.colostate.edu/pubs/crops/00305.html>.
- ⁴¹⁹ Carr, Patrick M. "Crop Rotation Benefits Of Annual Forages." *North Dakota State University Dickinson Research Extension*. 2006 Annual Report. <http://www.ag.ndsu.nodak.edu/dickinso/research/2005/agron05f.htm>.
- ⁴²⁰ Singer, Jeremy. "Legume Living Mulches in Corn and Soybean." *Iowa State University Extension*. August 2005. <http://www.extension.iastate.edu/Publications/PM2006.pdf>.
- ⁴²¹ Lehmann, Johannes. "Biochar: the new frontier." *Soil Biogeochemistry Program*. Cornell University.
- ⁴²² Moravec, Catherine, J. Reeder, D. Whiting, and C. Wilson. "Soil Amendments." *University of Colorado Extension*. *Colorado Master Gardener Garden Notes*. 241-1. December 2009. <http://www.cmg.colostate.edu/gardennotes/241.pdf>.
- ⁴²³ Ibid.

- ⁴²⁴ Frasier, M., A. Hornung, D. Inman, et al. "A synthesis of multi-disciplinary research in precision agriculture: site-specific management zones in the semi-arid western Great Plains of the USA." *Precision Agriculture* 9, no. 1-2. 85-100. 3 March, 2008. <http://0-www.springerlink.com.bianca.penlib.du.edu/content/n733241lm08p6116/fulltext.pdf>
- ⁴²⁵ Abnstedt, Bret, J. G. Davis, and M. Young. "Soil characteristics of cropland fertilized with feedlot manure in the South Platte River basin of Colorado." *Journal of Soil and Water Conservation* 52. no. 5. 327. 1997. http://0-find.galegroup.com.bianca.penlib.du.edu/gtx/downloadDocument.do?contentSet=IAC-Documents&workId=&tabID=T002&docId=A20418438&prodId=AONE&callistoContentSet=&userGroupNa me=udenver&noOfPages=&pageIndex=0&inPS=true&pdfHigherLimit=&actionCmd=DO_LIST_
<http://0-find.galegroup.com.bi>
- ⁴²⁶ Ibid.
- ⁴²⁷ Frasier, M., A. Hornung, D. Inman, et al. "A synthesis of multi-disciplinary research in precision agriculture: site-specific management zones in the semi-arid western Great Plains of the USA." *Precision Agriculture* 9, no. 1-2 (3 March, 2008): 85-100. Springer. <http://0-www.springerlink.com.bianca.penlib.du.edu/content/n733241lm08p6116/fulltext.pdf>
- ⁴²⁸ Mosier, Arvin, C. Kroeze, C. Nevison, et al. "Closing the global N₂O budget: nitrous oxide emissions through the agricultural nitrogen cycle." *Nutrient Cycling in Agroecosystems*. Volume 52, Numbers 2-3, 225-248, DOI: 10.1023/A: 1009740530221 <http://www.springerlink.com/content/lu04703848m261w5/>
- ⁴²⁹ Cole, V., C. Cerri, K. Minami, et al. "Chapter 23. Agricultural Options for Mitigation of Greenhouse Gas Emissions." pp 745–771. Climate Change 1995. Impacts, Adaptations and Mitigation of Climate Change: Scientific- Technical Analyses. Published for the Intergovernmental Panel on Climate Change. Cambridge University Press, Cambridge. 1996
- ⁴³⁰ Bellarby, Jessica, B. Foereid, A. Hastings, and P. Smith. "Cool Farming: Climate Impacts of Agriculture and Mitigation Potential." *Greenpeace Report*. January 2008. <http://www.greenpeace.org/raw/content/international/press/reports/cool-farming-full-report.pdf>
- ⁴³¹ Bouwman, A.F. "Direct emission of nitrous oxide from agricultural soils." *Nutrient Cycling in Agroecosystems*. 46: 53–70. 1996.
- ⁴³² Schonbeck, Mark. "Ecologically Sound Nitrogen Management: One Researcher's Educated Guess." Online article for the *Northeast Organic Farming Association*. 5 February 2004. <http://www.nofa.org/tnf/nitrogen.php>
- ⁴³³ Ibid.
- ⁴³⁴ Scialabba, Nadia El-Hage and C. Hattam. "Organic Agriculture, Environment and Food Security." *Food and Agriculture Organization of the United Nations*. 2002. <http://www.fao.org/DOCREP/005/Y4137E/Y4137E00.HTM>
- ⁴³⁵ Bellarby, Jessica, B. Foereid, A. Hastings, and P. Smith. "Cool Farming: Climate Impacts of Agriculture and Mitigation Potential." *Greenpeace Report*. January 2008. <http://www.greenpeace.org/raw/content/international/press/reports/cool-farming-full-report.pdf>
- ⁴³⁶ Bouwman, A.F. "Direct emission of nitrous oxide from agricultural soils." *Nutrient Cycling in Agroecosystems*. 46: 53–70. 1996.
- ⁴³⁷ Roberts, Roland K., Burton C. English, and S.B. Mahajanashetti. "Evaluation the Returns to Variable Rate Nitrogen Application." *Journal of Agriculture and Applied Economics*, 32, no. 1: 133-143. 2000. <http://ageconsearch.umn.edu/bitstream/15393/1/32010133.pdf>.
- ⁴³⁸ Danso S.K.A. "Sustainable agriculture. The role of biological nitrogen fixing plants." IAEA (ed) *Nuclear Techniques in Soil- Plant Studies for Sustainable Agriculture and Environmental Preservation*. pp 205–224. IAEA, Vienna. 1995.

- ⁴³⁹ Bartolo, Michael E., R. F. Follett, A. D. Halvorson, and F. C. Schweissing, "Nitrogen Fertilizer Use Efficiency of Furrow-Irrigated Onion and Corn." *Agronomy Journal* 94, 442-447. May-June, 2002. <http://ddr.nal.usda.gov/bitstream/10113/11395/1/IND23284332.pdf>.
- ⁴⁴⁰ Zhang, Hailin. Stiegler, Jim. "Animal Manure and Soil Quality." *Production Technology*. Oklahoma Cooperative Extension Service. February 1998.
- ⁴⁴¹ Risse, L.M. et al. "Land Application of Manure for Beneficial Reuse." Animal Agriculture and the Environment: National Center for Manure and Animal Waste Management White Papers. Pp. 283-316. Published by the *American Society of Agricultural and Biological Engineers*. 2006
- ⁴⁴² Bauder, Troy. Et al. "Best Management Practices for Colorado Corn". Best Management Practices for Colorado Corn. *Colorado State University Cooperative Extension*. February 2003.
- ⁴⁴³ Davis, J.G. et al. "Feedlot Manure Management." Livestock Series No 1.220. *Colorado State University Extension*.
<http://www.cde.state.co.us/artemis/UCSU20/UCSU2062212202002INTERNET.pdf>
- ⁴⁴⁴ "2007 Census of Agriculture: Colorado State and County Data." *United States Department of Agriculture National Agricultural Statistics Service*. December 2009.
http://www.agcensus.usda.gov/Publications/2007/Full_Report/Volume_1,_Chapter_1_State_Level/Colorado/cov1.pdf.
- ⁴⁴⁵ Bauder, Troy. Et al. "Best Management Practices for Colorado Corn". Best Management Practices for Colorado Corn. *Colorado State University Cooperative Extension*. February 2003.
- ⁴⁴⁶ Ibid.
- ⁴⁴⁷ Ibid.
- ⁴⁴⁸ "Costs of Manure Application and Transport." *Colorado State University: Extension*. 14 February 2011. http://www.extension.org/pages/Costs_of_Manure_Application_and_Transport
- ⁴⁴⁹ Ibid.
- ⁴⁵⁰ Elliott, A.L., J.G. Davis, R.M. Waskom, J.R. Self and D.K. Christensen. "Phosphorus Fertilizers for Organic Farming Systems." October 2009. <http://www.ext.colostate.edu/pubs/crops/00569.html>.
- ⁴⁵¹ Rector, Natalie and Jon Rausch. "Optimizing Use of Nutrients for Crops: Dairy Manure Replaces Commercial Fertilizer." *Michigan State University: Extension*.
<http://www.animalagteam.msu.edu/Portals/0/Optimizing%20Use%20of%20Nutrients%20for%20Crops.doc>.
- ⁴⁵² Barbarick, K.A., N.C. Hansen, and J.P. McDaniel. "Biosolids Application to No-Till Dryland Rotations: 2008 Results." *Colorado State University: Agricultural Experiment Station*. 4 April 2010.
<http://digitool.library.colostate.edu/webclient/DeliveryManager?pid=82508>.
- ⁴⁵³ Bauder, Troy, and R. M. Waskom. "Best Management Practices for Phosphorus Fertilization." *Colorado State University: Extension*.
<http://library.du.edu/clickthrough/index.php/clicks/?type=cou&url=http://www.ext.colostate.edu/pubs/crops/xcm175.pdf>
- ⁴⁵⁴ Bauder, T.A., G.E. Cardon, J.G. Davis, and R.M. Waskom. "Managing Saline Soils." *Colorado State University Extension*. 12 May, 2010. <http://www.ext.colostate.edu/pubs/crops/00503.html>.

6. Inputs

- ⁴⁵⁵ “Colorado agriculture [electronic source]: a profile.” *United States Department of Agriculture. Colorado Agriculture Statistic Services*. April 2009.
- ⁴⁵⁶ Park, Timothy. “Farm Income and Costs: 2011 Farm Sector Income Forecast.” *United States Department of Agriculture*. <http://www.ers.usda.gov/briefing/farmincome/nationalestimates.htm>
- ⁴⁵⁷ Ibid.
- ⁴⁵⁸ Edwards, Clive A. “The importance of integration in sustainable agricultural systems.” *Agriculture, Ecosystems & Environment*, 27, no.1-4. 25-35. 1989.
- ⁴⁵⁹ Park, Timothy. “Farm Income and Costs: 2011 Farm Sector Income Forecast.” *United States Department of Agriculture*. <http://www.ers.usda.gov/briefing/farmincome/nationalestimates.htm>
- ⁴⁶⁰ “Colorado agriculture [electronic source]: a profile.” *United States Department of Agriculture. Colorado Agriculture Statistic Services*. April 2009.
- ⁴⁶¹ Fernandez-Cornejo, Jorge, and William D. McBride, “Genetically Engineered Crops for Pest Management in U.S. Agriculture: Farm-Level Effects.” *United States Department of Agriculture Economic Research Service*. April 2000. <http://www.ers.usda.gov/publications/AER786/>.
- ⁴⁶² E. Beus, Curtis and R. E. Dunlap. “Conventional versus Alternative Agriculture The Paradigmatic Roots of the Debate.” *Rural Sociology*. 55(4): pp-590-616. 1990. <http://www.soc.iastate.edu/class/325/beus.pdf> p. 591
- ⁴⁶³ W. Huang. “Impact of Rising Natural Gas Prices on U.S. Ammonia Supply.” *USDA*. p1-2 2007. http://usda.mannlib.cornell.edu/usda/ers/WRS/2000s/2007/WRS-08-06-2007_Special_Report.pdf
- ⁴⁶⁴ Schnepf, Randy. “Energy Use in Agriculture: Background and Issues.” *Congressional Research Service*. 19 November 2004.
- ⁴⁶⁵ W. Huang. “Agricultural Chemicals and Production Technology: Nutrient Management.” *USDA Economic Research Service*. 2005. <http://www.ers.usda.gov/Briefing/AgChemicals/nutrientmangement.htm>
- ⁴⁶⁶ “Colorado agriculture [electronic source]: a profile.” *United States Department of Agriculture. Colorado Agriculture Statistic Services*. April 2009.
- ⁴⁶⁷ W. Huang. “Agricultural Chemicals and Production Technology: Nutrient Management.” *USDA Economic Research Service*. 2005. <http://www.ers.usda.gov/Briefing/AgChemicals/nutrientmangement.htm>
- ⁴⁶⁸ Schnepf, Randy. “Energy Use in Agriculture: Background and Issues.” *Congressional Research Service*. 19 November 2004.
- ⁴⁶⁹ Ibid.
- ⁴⁷⁰ W. Huang. “Impact of Rising Natural Gas Prices on U.S. Ammonia Supply.” *USDA*. p1-2 2007. http://usda.mannlib.cornell.edu/usda/ers/WRS/2000s/2007/WRS-08-06-2007_Special_Report.pdf
- ⁴⁷¹ W. Huang. “Factors Contributing to the Recent Increase in U.S. Fertilizer Prices, 2001-08.” *USDA*. 2009. p 4 <http://www.ers.usda.gov/Publications/AR33/AR33.pdf>
- ⁴⁷² W. Huang. “Impact of Rising Natural Gas Prices on U.S. Ammonia Supply.” *USDA*. p1-2 2007. http://usda.mannlib.cornell.edu/usda/ers/WRS/2000s/2007/WRS-08-06-2007_Special_Report.pdf
- ⁴⁷³ Ibid.

- ⁴⁷⁴ W. Huang. "Factors Contributing to the Recent Increase in U.S. Fertilizer Prices, 2001-08." *USDA*. 2009. p 4 <http://www.ers.usda.gov/Publications/AR33/AR33.pdf>
- ⁴⁷⁵ Ibid.
- ⁴⁷⁶ W. Huang. "Impact of Rising Natural Gas Prices on U.S. Ammonia Supply." *USDA*. p1-22007. http://usda.mannlib.cornell.edu/usda/ers/WRS/2000s/2007/WRS-08-06-2007_Special_Report.pdf
- ⁴⁷⁷ W. Huang. "Factors Contributing to the Recent Increase in U.S. Fertilizer Prices, 2001-08." *USDA*. 2009. p 4 <http://www.ers.usda.gov/Publications/AR33/AR33.pdf>
- ⁴⁷⁸ Reducing Nitrogen Fertilizer and Indirect Energy Usage." *National Sustainable Agriculture Information Service*. 2010. http://attra.ncat.org/attra-pub/farm_energy/nitrogen.html
- ⁴⁷⁹ Koehler, B., and B. Lazarus. "Determining Manure Value." *University of Minnesota*. 2007. <http://swroc.cfans.umn.edu/Bob/docs/manurevalue.pdf>
- ⁴⁸⁰ "2007 Census of Agriculture: Colorado State and County Data." *United States Department of Agriculture National Agricultural Statistics Service*. December 2009. http://www.agcensus.usda.gov/Publications/2007/Full_Report/Volume_1,_Chapter_1_State_Level/Colorado/cov1.pdf.
- ⁴⁸¹ Ibid.
- ⁴⁸² Entz, Marin H., A. J. Franzuebbers, and M. P. Russelle. "Reconsidering Integrated Crop-Livestock Systems in North America." *Agronomy Journal* 99. 6 Feb. 2007. www.fao.org/fileadmin/templates/agphome/.../wk1_c19_franzluebbbers.pdf.
- ⁴⁸³ Production Management: Pest Management." *USDA*. p. 181. <http://www.ers.usda.gov/publications/arei/ah712/AH7124-4.PDF>
- ⁴⁸⁴ Schnepf, Randy. "Energy Use in Agriculture: Background and Issues." *Congressional Research Service*. 19 November 2004.
- ⁴⁸⁵ "Production Management: Pest Management." *USDA*. p. 181. <http://www.ers.usda.gov/publications/arei/ah712/AH7124-4.PDF>
- ⁴⁸⁶ "The Future Role of Pesticides in US Agriculture." *National Academy of Press*, Washington DC. p. 36. 2000. http://books.nap.edu/openbook.php?record_id=9598&page=36
- ⁴⁸⁷ Fernandez-Cornejo, Jorge. "The Seed Industry in U.S. Agriculture." *Economic Research Service. United States Department of Agriculture*. January 2004. www.ers.usda.gov/publications/aib786/aib786.pdf.
- ⁴⁸⁸ Ibid.
- ⁴⁸⁹ Ibid.
- ⁴⁹⁰ Ibid.
- ⁴⁹¹ Ibid.
- ⁴⁹² Lupi, Claudio. "Genetic Engineering for Plant Protection." *BATS: Centre for Biosafety and Sustainability*. http://www.bats.ch/bats/publikationen/1995-1_TA/2-methods.php.
- ⁴⁹³ Fernandez-Cornejo, Jorge. "The Seed Industry in U.S. Agriculture." *Economic Research Service. United States Department of Agriculture*. (January 2004). www.ers.usda.gov/publications/aib786/aib786.pdf.
- ⁴⁹⁴ Jeff Schahczenski, Katherine Adam. "Transgenic Crops." *National Sustainable Agriculture Information Service*. 2006. <http://attra.ncat.org/attra-pub/geneticeng.html>.

- ⁴⁹⁵ Fernandez-Cornejo, Jorge, and William D. McBride, "Genetically Engineered Crops for Pest Management in U.S. Agriculture: Farm-Level Effects." *United States Department of Agriculture Economic Research Service*. April 2000. <http://www.ers.usda.gov/publications/AER786/>.
- ⁴⁹⁶ Ferry, Natalie, and Angharad M.R. Gatehouse [eds.]. "Environmental impact of genetically modified crops." *CABI Publishing* 35: Feb., 2009. <http://0-site.ebrary.com.bianca.penlib.du.edu/lib/udenver/docDetail.action?docID=10281501>.
- ⁴⁹⁷ "The First Decade of Genetically Engineered Crops in the United States." *United States Department of Agriculture. Economic Research Service*. 11 April 2006.
- ⁴⁹⁸ Byrne, P.F., and S. Fromherz. "Can GM and non-GM crops coexist? Setting a precedent in Boulder County, Colorado, USA." *Food, Agriculture, & Environment* 1. no. 2 258. 2003. <http://www.iphandbook.org/jforum/posts/downloadAttach/516.page>.
- ⁴⁹⁹ Riddle, Jim. "An Introduction to Organic Certification Requirements." *Colorado State University Extension*. 20, October, 2010. <http://www.extension.org/article/18735>
- ⁵⁰⁰ Byrne, P.F., and S. Fromherz. "Can GM and non-GM crops coexist? Setting a precedent in Boulder County, Colorado, USA." *Food, Agriculture, & Environment* 1. no. 2 258. 2003. <http://www.iphandbook.org/jforum/posts/downloadAttach/516>
- ⁵⁰¹ Thomison, P.R. "Managing 'Pollen Drift' to Minimize Contamination of Non-GMO Corn." *Ohio State University Extension. AGF_153_04*. 2001. ohioline.osu.edu/agf-fact/pdf/0153.pdf
- ⁵⁰² Ibid.
- ⁵⁰³ Ibid.
- ⁵⁰⁴ Whitman, Deborah B. "Genetically Modified Foods: Harmful or Helpful?" *CSA Discovery Guides*. April, 2000. <http://www.csa.com/discoveryguides/gmfood/review.pdf>
- ⁵⁰⁵ "Guide to U.S. Regulation of Genetically Modified Food and Agricultural Biotechnology Products." *Pew Initiative on Food and Biotechnology*. September 2001. http://www.pewtrusts.org/uploadedFiles/wwwpewtrustsorg/Reports/Food_and_Biotechnology/hs_biotech_0901.pdf
- ⁵⁰⁶ Ibid.
- ⁵⁰⁷ Ibid.
- ⁵⁰⁸ Ibid.
- ⁵⁰⁹ Korves, Ross. "Biotech Alfalfa Environmental Impact Statement." *The Truth About Trade and Technology*. 23 December 2010. <http://www.truthabouttrade.org/news/editorials/trade-policy-analysis/17118-biotech-alfalfa-environmental-impact-statement->
- ⁵¹⁰ "Gyphosate-Tolerant Alfalfa Events J101 and J163: Request for Nonregulated Status." *Animal and Plant Health Inspection Service. United States Department of Agriculture*. 27 January 2011. http://www.aphis.usda.gov/brs/aphisdocs/04_11001p_rod.pdf
- ⁵¹¹ Putnam, Daniel H. "Methods to Enable Coexistence of Diverse Production Systems Involving Genetically Engineered Alfalfa." *University of California: Division of Agriculture and Natural Resources. ucanr.org/freepubs/docs/8193.pdf*.
- ⁵¹² "Experts: Contamination from GM alfalfa certain." *Associated Press*. 7 February 2011. <http://www.google.com/hostednews/ap/article/ALeqM5jM3y4h6-OJoZysfZ2k056PfiNRHQ?docId=e1796a22a6784755aab777145b965992>
- ⁵¹³ "USDA Action to Support Continued Dialogue and Constructive Coexistence in U.S. Agriculture." *United States Department of Agriculture*. <http://www.google.com/url?sa=t&source=web&cd=1&ved=0CBMQFjAA&url=http%3A%2F%2Fwww.usda.gov%2Fdocuments%2FUSDAContinuedDialogueConstructiveCoexistence.pdf&rct=j>

&q=www.usda.gov%2F...%2FUSDAContinuedDialogueConstructiveCoexistence.pdf&ei=DnBU
TZ_9I1qCsQPngLHBBQ&usg=AFQjCNGqtnTHwiyVEo3kizKi7G9tqXt-
1g&sig2=KVFw6lcOjnH3SoGdrl9sUw&cad=rja

⁵¹⁴ Ibid.

⁵¹⁵ “USDA Completely Deregulates Genetically Engineered Alfalfa—It is Time to Demand Congressional Hearings!” *Alliance for Natural Health USA*. 1 February 2011. <http://www.anh-usa.org/usda-completely-deregulates-genetically-engineered-alfalfa-it-is-time-to-demand-congressional-hearings-action-alert/>

⁵¹⁶ “Center Announces Immediate Legal Challenge to USDA’s Flawed Assessment.” *Center for Food Safety*. 27 January 2011. <http://www.centerforfoodsafety.org/2011/01/27/usda-decision-on-ge-alfalfa-leaves-door-open-for-contamination-rise-of-superweeds/>

⁵¹⁷ Press Release: USDA Announces Partial Deregulation for Roundup Ready Sugar Beets. *U.S. Department of Agriculture*. http://www.aphis.usda.gov/newsroom/2011/02/rr_sugar_beets.shtml. 4 February 2011.

⁵¹⁸ Ibid.

⁵¹⁹ “Mandatory Condition Requirements for Roundup Ready Sugar Beets.” *United States Department of Agriculture*. http://www.aphis.usda.gov/brs/aphisdocs/03_32301p_req.pdf.

⁵²⁰ Ibid.

⁵²¹ Press Release: USDA Announces Partial Deregulation for Roundup Ready Sugar Beets. *U.S. Department of Agriculture*. http://www.aphis.usda.gov/newsroom/2011/02/rr_sugar_beets.shtml. 4 February 2011.

⁵²² Gillam, C. & Abbott, C. “USDA partially deregulating biotech sugar beets.” *Reuters*. <http://www.reuters.com/article/2011/02/05/us-sugarbeet-usda-idUSTRE71369O20110205>. February 4, 2011.

⁵²³ “Press Release: USDA Announces Partial Deregulation for Roundup Ready Sugar Beets.” *U.S. Department of Agriculture*. http://www.aphis.usda.gov/newsroom/2011/02/rr_sugar_beets.shtml. 4 February 2011.

⁵²⁴ Gillam, C. & Abbott, C. “USDA partially deregulating biotech sugar beets.” *Reuters*. <http://www.reuters.com/article/2011/02/05/us-sugarbeet-usda-idUSTRE71369O20110205>. February 4, 2011.

⁵²⁵ Jeffrey S. White, District Judge. No. 10-17719 D.C. No. 3:10-cv-04038-JSW. *United States Court of Appeals for the Ninth Circuit*. Feb 25, 2011. <http://www.ca9.uscourts.gov/datastore/opinions/2011/02/25/1017719.pdf>

⁵²⁶ Ibid.

⁵²⁷ Ibid.



7. Pest Management

- ⁵²⁸ Schnepf, Randy. "Energy Use in Agriculture: Background and Issues." *Congressional Research Service Report for congress: Received through the CRS Web*. Order Code RL32677. Table 5. 2004. www.nationalaglawcenter.org/assets/crs/RL32677.pdf
- ⁵²⁹ "Agricultural Chemicals and Production Technology: Pest Management." *USDA Economic Research Service*. 2005. <http://www.ers.usda.gov/Briefing/Agchemicals/pestmangement.htm>
- ⁵³⁰ Ibid.
- ⁵³¹ Pimentel D, A. Greiner, T. Bashore. "Economic and environmental costs of pesticide use." *Arch. Environ. Contam. Toxicol.* 21: 84–90. 1991.
- ⁵³² Schnepf, Randy. "Energy Use in Agriculture: Background and Issues." *Congressional Research Service Report for congress: Received through the CRS Web*. Order Code RL32677. Table 5. 2004. www.nationalaglawcenter.org/assets/crs/RL32677.pdf
- ⁵³³ "Agricultural Chemicals and Production Technology: Pest Management." *USDA Economic Research Service*. 2005. <http://www.ers.usda.gov/Briefing/Agchemicals/pestmangement.htm>.
- ⁵³⁴ Schnepf, Randy. "Energy Use in Agriculture: Background and Issues." *Congressional Research Service Report for congress: Received through the CRS Web*. Order Code RL32677. Table 5. 2004. www.nationalaglawcenter.org/assets/crs/RL32677.pdf
- ⁵³⁵ "Agricultural Chemicals and Production Technology: Pest Management." *USDA Economic Research Service*. 2005. <http://www.ers.usda.gov/Briefing/Agchemicals/pestmangement.htm>.
- ⁵³⁶ Ibid.
- ⁵³⁷ Ibid.
- ⁵³⁸ Ibid.
- ⁵³⁹ Knutson, Ronald D. and Edward G. Smith. "Economic Impacts of the Elimination of Organophosphates and Carbamates on Texas Agriculture." *Texas A& M Agriculture and Food Policy Center Working Paper 99-3*. April 1999.
- ⁵⁴⁰ Sexton, Steven E., Zhen Lei, and David Zilberman. "The Economics of Pesticides and Pest Control". *International Review of Environmental and Resource Economics*. 1: 271-326. 2007.
- ⁵⁴¹ Schnepf, Randy. "Energy Use in Agriculture: Background and Issues." *Congressional Research Service Report for congress: Received through the CRS Web*. Order Code RL32677. Table 5. 2004. www.nationalaglawcenter.org/assets/crs/RL32677.pdf
- ⁵⁴² "Colorado agriculture [electronic source]: a profile." *United States Department of Agriculture. Colorado Agriculture Statistic Services*. April 2009.
- ⁵⁴³ Sexton, S.E., et al. "The Economics of Pesticides and Pest Control." *International Review of Environmental and Resource Economics*, 2007, 1: 271–326
- ⁵⁴⁴ Zilberman, David., et al. "The Economics of Pesticide Use and Regulation." *Science*. August 1991. Vol. 253 no.5019 pp.518-522
- ⁵⁴⁵ Sexton, S.E., et al. "The Economics of Pesticides and Pest Control." *International Review of Environmental and Resource Economics*, 2007, 1: 271–326
- ⁵⁴⁶ Knutson, R. D. et al. "Economic impacts of reduced, chemical use." *Agricultural and Food Policy Center*. 1990

- 547 Pimental, David. "Environmental And Economic Costs of the Application of Pesticides Primarily in the United States." *Environment, Development and Sustainability*. 2005. Vol 7: 229-252
- 548 Ibid.
- 549 Ibid.
- 550 Fernando-Cornejo, Jorge, Sharon Jans, and Mark Smith. "Issues in the Economics of Pesticide Use in Agriculture: A Review of the Empirical Evidence." *Review of Agricultural Economics*. 20,2: 462-488. 1998.
- 551 Zadoks, J. C. and H. Waibel. "From Pesticides to Genetically Modified Plants: History, Economics, and Politics." *Netherlands Journal of Agricultural Science*. 48 (2000) 125-149
- 552 Fernando-Cornejo, Jorge, Sharon Jans, and Mark Smith. "Issues in the Economics of Pesticide Use in Agriculture: A Review of the Empirical Evidence." *Review of Agricultural Economics*. 20,2: 462-488. 1998.
- 553 Sexton, Steven E., Zhen Lei, and David Zilberman. "The Economics of Pesticides and Pest Control". *International Review of Environmental and Resource Economics*. 1: 271-326. 2007.
- 554 Fernando-Cornejo, Jorge, Sharon Jans, and Mark Smith. "Issues in the Economics of Pesticide Use in Agriculture: A Review of the Empirical Evidence." *Review of Agricultural Economics*. 20,2: 462-488. 1998.
- 555 Sexton, Steven E., Zhen Lei, and David Zilberman. "The Economics of Pesticides and Pest Control". *International Review of Environmental and Resource Economics*. 1: 271-326. 2007.
- 556 Fernando-Cornejo, Jorge, Sharon Jans, and Mark Smith. "Issues in the Economics of Pesticide Use in Agriculture: A Review of the Empirical Evidence." *Review of Agricultural Economics*. 20,2: 462-488. 1998.
- 557 Knutson, Ronald D. and Edward G. Smith. "Economic Impacts of the Elimination of Organophosphates and Carbamates on Texas Agriculture." *Texas A& M Agriculture and Food Policy Center Working Paper 99-3*. April 1999.
- 558 Fernando-Cornejo, Jorge, Sharon Jans, and Mark Smith. "Issues in the Economics of Pesticide Use in Agriculture: A Review of the Empirical Evidence." *Review of Agricultural Economics*. 20,2: 462-488. 1998.
- 559 "Production Management: Pest Management." *USDA*. p. 182.
<http://www.ers.usda.gov/publications/arei/ah712/AH7124-4.PDF>
- 560 Pimentel, D., A. Greiner, and T. Bashore. "Economic and environmental costs of pesticide use." *Arch. Environ. Contam. Toxicol.* 21:84-90. 1991.
- 561 Fernandez-Cornejo, Jorge, and S. Jans. "Pest Management in U.S. Agriculture." *Resource Economics Division, Economic Research Service, U.S. Department of Agriculture*. Agricultural Handbook No. 717.
- 562 "The First Decade of Genetically Engineered Crops in the United States." *United States Department of Agriculture Economic Research Service*. 11 April 2006.
<http://www.ers.usda.gov/publications/eib11/eib11c.pdf>.
- 563 Ibid.
- 564 Ibid.
- 565 "Adoption of Genetically Engineered Crops in the U.S." *USDA Economic Research Service*. 2010.
<http://www.ers.usda.gov/data/biotechcrops/>

- ⁵⁶⁶ “Crop Genetic Diversity Boosts Productivity But Faces Threats.” *USDA Economic Research Service*. 2005. <http://www.ers.usda.gov/AmberWaves/September05/pdf/FindingsRESeptember2005.pdf>.
- ⁵⁶⁷ “Adoption of Genetically Engineered Crops in the U.S.” *USDA Economic Research Service*. 2010. <http://www.ers.usda.gov/data/biotechcrops/>
- ⁵⁶⁸ Schadczeni, J., and K. Adam. “Transgenic Crops.” *National Sustainable Agriculture Information Service*. 2006. <http://attra.ncat.org/attra-pub/geneticeng.html>.
- ⁵⁶⁹ Fernandez-Cornejo, Jorge, and William D. McBride, “Genetically Engineered Crops for Pest Management in U.S. Agriculture: Farm-Level Effects.” *United States Department of Agriculture Economic Research Service*. April 2000. <http://www.ers.usda.gov/publications/AER786/>.
- ⁵⁷⁰ “Agricultural Chemicals and Production Technology: Genetically Engineered Crops.” *USDA Economic Research Service*. 27 April, 2005. <http://www.ers.usda.gov/briefing/agchemicals/geneticengineered.htm>
- ⁵⁷¹ Fernandez-Cornejo, Jorge, and William D. McBride, “Genetically Engineered Crops for Pest Management in U.S. Agriculture: Farm-Level Effects.” *United States Department of Agriculture Economic Research Service*. April 2000. <http://www.ers.usda.gov/publications/AER786/>.
- ⁵⁷² Byrne, P.F., and Fromherz, S. “Can GM and non-GM crops coexist? Setting a precedent in Boulder County, Colorado, USA.” *Food, Agriculture & Environment* 1, no. 2: 258-261. 2003. <http://www.iphandbook.org/jforum/posts/downloadAttach/516>.
- ⁵⁷³ Current Opinion in Biotechnology 2006, 17:105–112
- ⁵⁷⁴ J. Schadczeni, K. Adam. “Transgenic Crops.” *National Sustainable Agriculture Information Service*. 2006 <http://attra.ncat.org/attra-pub/geneticeng.html>.
- ⁵⁷⁵ Ibid.
- ⁵⁷⁶ James, C. “Global Status of Commercialized Transgenic Crops: 2003.” *International Service for the Acquisition of Agri-Biotech Applications*. 2003.
- ⁵⁷⁷ Fernandez Cornejo J and M. Caswell. “The First Decade of Genetically Engineered Crops in the United States.” *United States Department of Agriculture, Economic Research Service*, Washington, DC. 2006. <http://www.ers.usda.gov/publications/EIB11>
- ⁵⁷⁸ Ibid.
- ⁵⁷⁹ Sankula S, G. Marmon and E. Blumenthal. “Biotechnology-Derived Crops Planted in 2004 – Impacts on US Agriculture.” *National Center for Food and Agricultural Policy*, Washington, D.C. 2005. <http://www.ncfap.org/whatwedo/pdf/2004biotechimpacts.pdf>
- ⁵⁸⁰ Brookes, G. and P. Barfoot. “GM crops: the global economic and environmental impact – the first nine years 1996–2004.” *AgBioForum* 8:187–196. 2005. <http://www.agbioforum.org/v8n23/v8n23a15-brookes.htm>
- ⁵⁸¹ Benbrook, C. M., “Impacts of Genetically Engineered Crops on Pesticide Use in the United States: The First Nine Years.” *BioTech InfoNet Technical Paper Number 7, Ag Biotech InfoNet, Ecologic, Inc.*, Sandpoint. 2004. Available: [http://www.biotech-info.net/Full version first nine.pdf](http://www.biotech-info.net/Full%20version%20first%20nine.pdf)
- ⁵⁸² “Agricultural Chemical Usage (PCU-BB).” *National Agricultural Statistics Service, Agricultural Statistics Board, US Department of Agriculture*, Washington, DC. 2006. <http://usda.mannlib.cornell.edu/MannUsda/viewDocumentInfo.do?documentID=1001>
- ⁵⁸³ Benbrook, C.M. “Impacts of Genetically Engineered Crops on Pesticide Use in the United States: The First Nine Years.” *BioTech InfoNet Technical Paper Number 7, Ag Biotech InfoNet, Ecologic, Inc.*, Sandpoint. 2004. Available: [http://www.biotech-info.net/Full version first nine.pdf](http://www.biotech-info.net/Full%20version%20first%20nine.pdf)
- ⁵⁸⁴ “Agricultural Chemical Usage (PCU-BB).” *National Agricultural Statistics Service, Agricultural Statistics Board, U.S. Department of Agriculture*, Washington, DC. 2006.

- <http://usda.mannlib.cornell.edu/MannUsda/viewDocumentInfo.do?documentID=1001>
- 585 Fernandez, Cornejo J. and M. Caswell. "The First Decade of Genetically Engineered Crops in the United States." *United States Department of Agriculture, Economic Research Service*, Washington, DC. 2006. <http://www.ers.usda.gov/publications/EIB11>
- 586 Ibid.
- 587 Ibid.
- 588 Ferry, Natalie, and A. M. R. Gatehouse. "Environmental impact of genetically modified crops." *CABI Publishing*. 117. February 2009. <http://0-site.ebrary.com.bianca.penlib.du.edu/lib/udenver/docDetail.action?docID=10281501>.
- 589 Ibid.
- 590 Ibid.
- 591 Fernandez-Cornejo, Jorge, and William D. McBride. "Genetically Engineered Crops for Pest Management in U.S. Agriculture: Farm-Level Effects." *United States Department of Agriculture, Economic Research Service*. 21. April 2000.
- 592 "The First Decade of Genetically Engineered Crops in the United States." *United States Department of Agriculture Economic Research Service*. 11 April 2006. <http://www.ers.usda.gov/publications/eib11/eib11c.pdf>
- 593 Ferry, Natalie, and A. M. R. Gatehouse. "Environmental impact of genetically modified crops." *CABI Publishing*. 76. February 2009. <http://0-site.ebrary.com.bianca.penlib.du.edu/lib/udenver/docDetail.action?docID=10281501>.
- 594 Ibid.
- 595 "U.S. National Research Council, Committee on Pest and Pathogen Control." *Ecologically Based Pest Management: New Solutions for a New Century*. Washington, DC: National Academy Press. 1996.
- 596 "Herbicide Resistant Weeds of USA." *Weed Science Society of America, Herbicide Resistance Action Committee, North American Herbicide Resistance Action Committee*. 2009. <http://www.weedscience.org/summary/UniqueCountry.asp?lstCountryID=45>.
- 597 "Number of Resistant Biotypes." *Weed Science Society of America, Herbicide Resistance Action Committee, North American Herbicide Resistance Action Committee*. 2010. <http://www.weedscience.org/ChronIncrease.gif>.
- 598 "Herbicide Resistant Weeds of USA." *Weed Science Society of America, Herbicide Resistance Action Committee, North American Herbicide Resistance Action Committee*. 2009. <http://www.weedscience.org/summary/UniqueCountry.asp?lstCountryID=45>.
- 599 Powles, S. B. "Evolved glyphosate-resistant weeds around the world: lessons to be learnt." *Pest. Management Science.*, (2008). Vol. 64, 360–365
- 600 Powles, S. B; Lorraine-Colwill, D. F., Dellow, J. J. & Preston, C. "Evolved resistance to glyphosate in rigid ryegrass (*Lolium rigidum*) in Australia." *Weed Science.*, 1998. Vol 46, 604–607
- 601 Heap, I. "The international survey of herbicide resistant weeds." *WeedScience.org*, 2010. <http://www.weedscience.org/>. Accessed March 31, 2010.
- 602 "The Impact of Genetically Engineered Crops on Farm Sustainability in the United States." *National Research Council*. Washington, D.C. The National Academies Press. 2010.
- 603 Heap, I. "The international survey of herbicide resistant weeds." *WeedScience.org*, 2010. <http://www.weedscience.org/>. Accessed March 31, 2010.

- ⁶⁰⁴ Gressel, J. "Fewer constraints than proclaimed to the evolution of glyphosate-resistant weeds." *Resistant Pest Management* 8(2): 2–5. 1996.
- ⁶⁰⁵ Owen, M.D.K., and I.A. Zelaya. "Herbicide-resistant crops and weed resistance to herbicides." *Pest Management Science* 61(3): 301–311. 2005.
- ⁶⁰⁶ Johnson, W.G., M.D.K. Owen, G.R. Kruger, et al. "U.S. farmer awareness of glyphosate-resistant weeds and resistance management strategies." *Weed Technology*. 23(2): 308–312. 2009.
- ⁶⁰⁷ Mueller, T.C., P.D. Mitchell, B.G. Young, and A.S. Culpepper. Proactive versus reactive management of glyphosate-resistant or -tolerant weeds. *Weed Technology*. 19(4): 924–933. 2005.
- ⁶⁰⁸ "The Impact of Genetically Engineered Crops on Farm Sustainability in the United States." National Research Council. Washington, D.C.: *The National Academies Press*. 2010.
- ⁶⁰⁹ Palumbi, S.R. "Humans as the world's greatest evolutionary force." *Science* 293(5536): 1786–1790. 2001.
- ⁶¹⁰ Onstad, D.W. "Insect resistance management: Biology, economics, and prediction." *Elsevier*. San Diego, CA: 2008.
- ⁶¹¹ Matten, S.R., G.P. Head, and H.D. Quemada. "How governmental regulation can help or hinder the integration of Bt crops into IPM programs." *Integration of insect-resistant genetically modified crops within IPM programs, Progress in biological control*. Vol. 5. pp. 27–39. New York. 2008.
- ⁶¹² Thompson, G.D., S. Matten, I. Denholm, M.E. Whalon, and P. Leonard. "The politics of resistance management: Working towards pesticide resistance management globally." *Global pesticide resistance in arthropods*. pp. 146–164. Wallingford, UK: CAB International. 2008.
- ⁶¹³ Tabashnik, B.E., J.B.J. Van Rensburg, and Y. Carrière. "Field-evolved insect resistance to Bt crops: Definition, theory, and data." *Journal of Economic Entomology* 102: 2011–2025. 2009.
- ⁶¹⁴ Tabashnik, B.E., A.J. Gassmann, D.W. Crowder, and Y. Carrière. "Insect resistance to Bt crops: Evidence versus theory." *Nature Biotechnology* 26(2): 199–202. 2008.
- ⁶¹⁵ Tabashnik, B.E., and Y. Carrière. "Evolution of insect resistance to transgenic plants." *Specialization, speciation, and radiation: The evolutionary biology of herbivorous insects, The Evolutionary Biology of Herbivorous Insects*. pp. 267–279. Berkeley: University of California Press. 2008.
- ⁶¹⁶ Matten, S.R., G.P. Head, and H.D. Quemada. "How governmental regulation can help or hinder the integration of Bt crops into IPM programs." *Integration of insect-resistant genetically modified crops within IPM programs, Progress in biological control*. Vol. 5. pp. 27–39. New York: Springer. 2008.
- ⁶¹⁷ Van Rensburg, J.B.J. "First report of field resistance by the stem borer, *Busseola fusca* (Fuller) to Bt-transgenic maize." *South African Journal of Plant and Soi*. 24(3): 147–151. 2007.
- ⁶¹⁸ Kruger, M., J.B.J. Van Rensburg, and J. Van den Berg. "Perspective on the development of stem borer resistance to Bt maize and refuge compliance at the Vaalharts irrigation scheme in South Africa." *Crop Protection*. 28(8): 684–689. 2009.
- ⁶¹⁹ Georghiou, G.P. "The magnitude of the resistance problem." *Pesticide resistance: Strategies and tactics for management*. pp. 14–43. Washington, DC: National Academies Press. 1986.
- ⁶²⁰ Alexandratos, N. "World Agriculture: Towards 2010: An FAO Study. Chichester, England." *Food and Agriculture Organization of the United Nations/John Wiley & Sons*. 1995.
- ⁶²¹ Ehler, L. E. "Perspective integrated pest management (IPM): definition, historical development and implementation, and the other IPM." *Pest Man. Sci*. 62:787-789. 2006.
- ⁶²² Sullivan, Preston. "Overview of Cover Crops and Green Manures." (ATTRA) *National Sustainability Agriculture Information Service*. 2003. <http://attra.ncat.org/attra-pub/covercrop.html#cover>.

-
- ⁶²³ Ehler, L. E. "Perspective integrated pest management (IPM): definition, historical development and implementation, and the other IPM." *Pest Man. Sci.* 62:787-789. 2006.
- ⁶²⁴ Weiss, James E. and J. Funderburk. "Assessment of Implementation and Sustainability of Integrated Pest Management Programs." *Florida Entomologist* 92(1). March 2009.
- ⁶²⁵ Sullivan, Preston. "Overview of Cover Crops and Green Manures." (ATTRA) *National Sustainability Agriculture Information Service*. 2003. <http://attra.ncat.org/attra-pub/covercrop.html#cover>.
- ⁶²⁶ Kuepper, George. "Pursuing Conservation Tillage Systems for Organic Crop Production." *NCAT/ATTRA National Sustainable Agriculture Information Service*. June 2001. <http://attra.ncat.org/attra-pub/organicmatters/conservationtillage.html>
- ⁶²⁷ Van Lenteren, J. C. "Integrated pest management in protected crops." *Integrated Pest Management*. Chapman and Hall, London, 1995.
- ⁶²⁸ Fernandez-Cornejo, J., and W.D. McBride. "Adoption of bioengineered crops. Agricultural economic report no. 810." *U.S. Department of Agriculture Economic Research Service*. Washington, D.C. May 1, 2002. <http://www.ers.usda.gov/publications/aer810/> Accessed July 25, 2009.
- ⁶²⁹ Smith, K.R. "Does off-farm work hinder "smart" farming?" *Agricultural outlook*. U.S. Department of Agriculture—Economic Research Service, AGO-294, 294: 28–30. September 2002. <http://usda.mannlib.cornell.edu/ers/AO/>.

8. Biodiversity

- ⁶³⁰ "What's Happening to Agrobiodiversity?" Food and Agriculture Organization (FAO), 1999. Available at the FAO Website: <http://www.fao.org/docrep/007/y5609e/y5609e02.htm> (8/23/07).
- ⁶³¹ Lori Ann Thrupp, *Linking Biodiversity and Agriculture: Challenges and Opportunities for Sustainable Food Security* (Washington: World Resources Institute, 1997). NAL Call # HC57 E5W755 no. 1997 March.
- ⁶³² Cromwell, Elizabeth. "Agriculture, biodiversity and livelihoods: issues and entry points." *Overseas Development Institute*. April 1999.
- ⁶³³ Altieri, Miguel A. "The Ecological role of biodiversity in agroecosystems." *Agriculture, Ecosystems and Environment* 74 (1999): 21.
<http://www.geography.siu.edu/courses/429/AgroEco/AgroEcoC.pdf>
- ⁶³⁴ Lori Ann Thrupp, *Linking Biodiversity and Agriculture: Challenges and Opportunities for Sustainable Food Security* (Washington: World Resources Institute, 1997). NAL Call # HC57 E5W755 no. 1997 March.
- ⁶³⁵ Altieri, Miguel A. "The Ecological role of biodiversity in agroecosystems." *Agriculture, Ecosystems and Environment* 74 (1999): 19-31.
<http://www.geography.siu.edu/courses/429/AgroEco/AgroEcoC.pdf>
- ⁶³⁶ Tuxill, John. "Appreciating the Benefits of Plan Biodiversity." *State of the World* (1999).
http://www.globalchange.umich.edu/gctext/Inquiries/Inquiries_by_Unit/Module%20Activities/State%20of%20the%20World/Plant%20biodiversity.pdf
- ⁶³⁷ Altieri, Miguel A. "The Ecological role of biodiversity in agroecosystems." *Agriculture, Ecosystems and Environment* 74 (1999): 19-31.
<http://www.geography.siu.edu/courses/429/AgroEco/AgroEcoC.pdf>
- ⁶³⁸ Tuxill, John. "Appreciating the Benefits of Plan Biodiversity." *State of the World*. 1999.
http://www.globalchange.umich.edu/gctext/Inquiries/Inquiries_by_Unit/Module%20Activities/State%20of%20the%20World/Plant%20biodiversity.pdf
- ⁶³⁹ Ibid.
- ⁶⁴⁰ Ibid.
- ⁶⁴¹ Wolfenbarger, L. L. "The Ecological Risks and Benefits of Genetically Engineered Plants." *Science* 290, no. 5499 (December 15, 2000): 2088. *Academic Search Premier*, EBSCOhost (accessed December 9, 2010).
- ⁶⁴² Tuxill, John. "Appreciating the Benefits of Plan Biodiversity." *State of the World*. 102. 1999.
http://www.globalchange.umich.edu/gctext/Inquiries/Inquiries_by_Unit/Module%20Activities/State%20of%20the%20World/Plant%20biodiversity.pdf
- ⁶⁴³ Ibid.
- ⁶⁴⁴ Ibid.
- ⁶⁴⁵ Ibid.
- ⁶⁴⁶ Ibid.
- ⁶⁴⁷ National Center for Genetic Resources Preservation (NCGRP). 2008.
<http://www.ars.usda.gov/Aboutus/docs.htm?docid=17886>
- ⁶⁴⁸ S. Pimm, T. Brooks. "The Sixth Extinction: How Large, Where, and When." *Department of Ecology and Evolutionary Biology*, University of Tennessee, Knoxville, Tn. Pg. 358. 1997.
<http://books.google.com/books?hl=en&lr=&id=nDgrAAAAAYAAJ&oi=fnd&pg=PA46&dq=sixth+ex>

- inction&ots=dF3-GMdA62&sig=GbZbR18xLsaEWqJAIKm5rorMIs0#v=onepage&q=sixth%20extinction&f=false
- ⁶⁴⁹ Tuxill, John. "Appreciating the Benefits of Plan Biodiversity." *State of the World*. 108. 1999. http://www.globalchange.umich.edu/gctext/Inquiries/Inquiries_by_Unit/Module%20Activities/State%20of%20the%20World/Plant%20biodiversity.pdf
- ⁶⁵⁰ Altieri, Miguel A. "The Ecological role of biodiversity in agroecosystems." *Agriculture, Ecosystems and Environment* 74: 21. 1999. <http://www.geography.siu.edu/courses/429/AgroEco/AgroEcoC.pdf>
- ⁶⁵¹ Brosi, Berry, Daily, Gretchen C., Ehrlich, Paul R., Fischer, Joern, Goldman, Rebecca, Goldstein, Joshua, Lindenmayer, David B., Manning, Adrian D., Mooney, Harold A., Pejchar, Liba, Ranganathan, Jai, and Tallis, Heather. "Should agricultural policies encourage land sparing or wildlife-friendly farming?" *The Ecological Society of America*. 2008. [http://classes.uleth.ca/200803/geog3090a/Fischer%20et%20al%202008%20\(for%20later%20biodiversity%20section\).pdf](http://classes.uleth.ca/200803/geog3090a/Fischer%20et%20al%202008%20(for%20later%20biodiversity%20section).pdf).
- ⁶⁵² Daly, Herman E. and Farley, Joshua. "Ecological Economics: Principles and Applications." *Island Press*. (pp. 158-159). 2003.
- ⁶⁵³ Nelson, Eric. "Modeling multiple ecosystem services, biodiversity conservation, commodity production, and tradeoffs at landscape scales." *Front Ecol Environ* 7(1): 4–11, doi:10.1890/080023. 2009
- ⁶⁵⁴ Power, Alison G. "Ecosystem services and agriculture: tradeoffs and synergies." *Philosophical Transactions of The Royal Society*. September 2010 vol. 365 no. 1554 2959-2971
- ⁶⁵⁵ Altieri, Miguel A. "The Ecological role of biodiversity in agroecosystems." *Agriculture, Ecosystems and Environment* 74: 19-31. 1999. <http://www.geography.siu.edu/courses/429/AgroEco/AgroEcoC.pdf>.
- ⁶⁵⁶ Ibid.
- ⁶⁵⁷ Tuxill, John. "Appreciating the Benefits of Plan Biodiversity." *State of the World*. 97. 1999. http://www.globalchange.umich.edu/gctext/Inquiries/Inquiries_by_Unit/Module%20Activities/State%20of%20the%20World/Plant%20biodiversity.pdf
- ⁶⁵⁸ S. Pimm, T. Brooks. "The Sixth Extinction: How Large, Where, and When." *Department of Ecology and Evolutionary Biology, University of Tennessee, Knoxville, Tn*. Pg. 358. 1997. <http://books.google.com/books?hl=en&lr=&id=nDgrAAAAYAAJ&oi=fnd&pg=PA46&dq=sixth+extinction&ots=dF3-GMdA62&sig=GbZbR18xLsaEWqJAIKm5rorMIs0#v=onepage&q=sixth%20extinction&f=false> 358
- ⁶⁵⁹ Tuxill, John. "Appreciating the Benefits of Plan Biodiversity." *State of the World*. 1999. http://www.globalchange.umich.edu/gctext/Inquiries/Inquiries_by_Unit/Module%20Activities/State%20of%20the%20World/Plant%20biodiversity.pdf
- ⁶⁶⁰ Wolfenbarger, L. L. and P. R. Phifer. "The Ecological Risks and Benefits of Genetically Engineered Plants." *Science's Compass. Science*. Vol. 290. p. 2089. 15 December 2000. <http://0-www.sciencemag.org.bianca.penlib.du.edu/content/290/5499/2088.full.pdf>
- ⁶⁶¹ Whitman, Deborah B. "Genetically Modified Foods: Harmful or Helpful?" *CSA Discovery Guides*. April 2000. <http://www.csa.com/discoveryguides/gmfood/review.pdf>.
- ⁶⁶² Ferry, Natalie and A. M. R. Gatehouse. "Environmental impact of genetically modified crops." *CABI Publishing*. 199-209. February 2009. <http://0-site.ebrary.com.bianca.penlib.du.edu/lib/udenver/docDetail.action?docID=10281501>.
- ⁶⁶³ Brussaard, Lijbert, P. C. de Ruiter, and G. G. Brown. "Soil biodiversity for agricultural sustainability." *Agriculture, Ecosystems, and Environment*. 121: 233–244. 15 February 2007



- ⁶⁶⁴ Pimentel, D.C., C. Wilson, C. McCullum, et al. "Economic and environmental benefits of biodiversity." *BioScience*. 47: 747–757. 1997.
- ⁶⁶⁵ Van der Putten, W.H., J.M. Anderson, R.D. Bardgett, et al. "The sustainable delivery of goods and services provided by soil biota." *Sustaining Biodiversity and Ecosystem Services in Soils and Sediments*. *Island Press*, San Francisco, pp. 15–43. 2004.
- ⁶⁶⁶ Hendrix, P.F., D. A. Crossley Jr., J. M. Blair, and D. C. Coleman. "Soil biota as components of sustainable agroecosystems." *Sustainable Agricultural Systems*. Soil and Water Conservation Society, Ankeny, USA, pp. 637–654. 1990.
- ⁶⁶⁷ Brown, G.G., M. J. Swift, D. E. Bennack, et al. "Management of soil biodiversity in agricultural systems." In: *Managing Biodiversity in Agricultural Systems*. *Columbia University Press*, in press.
- ⁶⁶⁸ Garbeva, P., J. A. van Veen, and J. D. van Elsas. "Microbial diversity in soil: selection of microbial populations by plant and soil type and implications for disease suppression." *Annu. Rev. Phytopathol.* 42: 243–270. 2004.
- ⁶⁶⁹ The´bault, E. and M. Loreau. "Food-web constraints on biodiversityecosystem functioning relationships." *Proc. Natl. Acad. Sci.* 25: 14949–14954. 2003.
- ⁶⁷⁰ Tilman, D. "The ecological consequences of changes in biodiversity: a search for general principles." *Ecology* 80: 1455–1474. 1999.
- ⁶⁷¹ Hendrix, P.F., D. A. Crossley Jr., J. M. Blair, and D. C. Coleman. "Soil biota as components of sustainable agroecosystems." *Sustainable Agricultural Systems*. Soil and Water Conservation Society, Ankeny, USA, pp. 637–654. 1990.
- ⁶⁷² Brown, G.G., M. J. Swift, D. E. Bennack, et al. "Management of soil biodiversity in agricultural systems." *Managing Biodiversity in Agricultural Systems*. *Columbia University Press*, in press.
- ⁶⁷³ Brussaard, Lijbert, P. C. de Ruiter, and G. G. Brown. "Soil biodiversity for agricultural sustainability." *Agriculture, Ecosystems, and Environment*. 121: 233–244. 15 February 2007
- ⁶⁷⁴ Brown, G.G., M. J. Swift, D. E. Bennack, et al. "Management of soil biodiversity in agricultural systems." In: *Managing Biodiversity in Agricultural Systems*. *Columbia University Press*, in press.
- ⁶⁷⁵ House, G.J. and R. W. Parmelee. "Comparison of soil arthropods and earthworms from conventional and no-tillage agroecosystems." *Soil Tillage Res.* 5: 351–360. 1985.
- ⁶⁷⁶ Collins, Wanda Williams. "Biodiversity in agroecosystems." *Boca Raton [u.a.]: CRC-Press*. 1999.
- ⁶⁷⁷ Brussaard, Lijbert, P. C. de Ruiter, and G. G. Brown. "Soil biodiversity for agricultural sustainability." *Agriculture, Ecosystems, and Environment*. 121: 233–244. 15 February 2007
- ⁶⁷⁸ Altieri, Miguel A. "The Ecological role of biodiversity in agroecosystems." *Agriculture, Ecosystems and Environment* 74: 21. 1999.
<http://www.geography.siu.edu/courses/429/AgroEco/AgroEcoC.pdf>.
- ⁶⁷⁹ Chiverton, P.A. and N. W. Sotherton. "The effects on beneficial arthropods of exclusion of herbicides from cereal crop edges." *Journal of Applied Ecology*. 28: 1027–1039. 1991.
- ⁶⁸⁰ Winston, M.L. "Nature Wars. People Vs. Pests." *Harvard University Press*, Cambridge, MA. 1997
- ⁶⁸¹ Ibid.
- ⁶⁸² Oldroyd, BP. "What's killing American honey bees?" *Public Library of Science*. (2007) 5: e168
- ⁶⁸³ Soil Association. "How does Organic Farming Benefit Wildlife?" Information Fact Sheet on Biodiversity. 12 December 2005.
<http://www.soilassociation.org/Web/SA/SAWeb.nsf/848d689047cb466780256a6b00298980/a7d79a080fe1ed3480256f6900372883!OpenDocument>

- ⁶⁸⁴ National Agricultural Statistics Service. "Honey Production." *US Department of Agriculture*, Washington, D.C., USA. 2009. <http://www.nass.usda.gov>
- ⁶⁸⁵ Cox-Foster, Diane L. et al. "A Metagenomic Survey of Microbes in Honey Bee Colony Collapse Disorder." *Science*. 318, 283. 2007
- ⁶⁸⁶ Oldroyd, BP. "What's killing American honey bees?" *Public Library of Science*. (2007) 5: e168
- ⁶⁸⁷ Van Engelsdorp, Dennis. Et al. "Colony Collapse Disorder: A Descriptive Study." *Public Library of Science*. 2009
- ⁶⁸⁸ National Agricultural Statistics Service. "Honey Production." *US Department of Agriculture*, Washington, D.C., USA. 2009. <http://www.nass.usda.gov>
- ⁶⁸⁹ Ellis, James D. et al. "Colony losses, managed colony population decline, and Colony Collapse Disorder in the United States." *Journal of Apicultural Research*. 49(1): 134-136 2010
- ⁶⁹⁰ Ibid.
- ⁶⁹¹ Morse, R A; Calderone, N.W. "The value of honey bees as pollinators of U.S. crops in 2000." *Bee Culture* 128: 1-15. 2000
- ⁶⁹² Chiverton, P.A. "The creation of within-field overwintering sites for natural enemies of cereal aphids." *Weeds*. pp. 1093–1096. Brighton Crop Protection Conference Publications, Farnham, UK. 1989.
- ⁶⁹³ Alexandratos, N. "World Agriculture: Towards 2010: An FAO Study." Chichester, England: *Food and Agriculture Organization of the United Nations/John Wiley & Sons*. 1995.
- ⁶⁹⁴ Hole, D.G., A.J. Perkins, J.D. Wilson, et al. "Does organic farming benefit biodiversity?" *Biological Conservation*. 122: 113–130. 2005.
- ⁶⁹⁵ Ibid.
- ⁶⁹⁶ Anon. "Standards for Organic Food Production, UKFROFS Reference OB4." 2001. (www.defra.gov.uk/farm/organic/ukrofs/standard/pdf).

9. Labor

- ⁶⁹⁷ Kandel, William. "United States Department of Agriculture, Economic Research Service." *Profile of Hired Farmworkers, A 2008 Update*. 2008.
- ⁶⁹⁸ United States Department of Commerce. Bureau of Economic Analysis. *Regional Economic Information Systems*. 2001–2007.
- ⁶⁹⁹ "State Fact Sheets: Colorado." *USDA Economic Research Service*. 2010.
<http://www.ers.usda.gov/statefacts/co.htm>
- ⁷⁰⁰ United States Department of Commerce. Bureau of Economic Analysis. *Regional Economic Information Systems*. 2001–2007.
- ⁷⁰¹ Bureau of Economic Analysis, U. S. Department of Commerce, 2009.
- ⁷⁰² Pena, Anita Alves, Dawn Thilmany McFadden, and Jessica Hernandez. "Economic Implications of Labor and Immigration Policy: The Case of Greeley's Swift Plant." *Agricultural Labor Report*. ALR 09-02. April 2009. <http://dare.colostate.edu/pubs/alr09-02.pdf>
- ⁷⁰³ McFadden, Dawn Thilmany, Anita Alvez Pena, and Jessica Hernandez. "Agricultural Labor in Colorado: Has Recent Immigration and Labor Policy Resulted from Colorado's Employment Trends?" *Agricultural Labor Report*. ALR 09-01. April 2009.
<http://dare.colostate.edu/pubs/alr09-01.pdf>
- ⁷⁰⁴ *Ibid.*
- ⁷⁰⁵ *Ibid.*
- ⁷⁰⁶ Pena, Anita Alves, Dawn Thilmany McFadden, and Jessica Hernandez. "Economic Implications of Labor and Immigration Policy: The Case of Greeley's Swift Plant." *Agricultural Labor Report*. ALR 09-02. April 2009. <http://dare.colostate.edu/pubs/alr09-02.pdf>
- ⁷⁰⁷ McFadden, Dawn Thilmany, Anita Alvez Pena, and Jessica Hernandez. "Agricultural Labor in Colorado: Has Recent Immigration and Labor Policy Resulted from Colorado's Employment Trends?" *Agricultural Labor Report*. ALR 09-01. April 2009.
<http://dare.colostate.edu/pubs/alr09-01.pdf>
- ⁷⁰⁸ *Ibid.*
- ⁷⁰⁹ *Ibid.*
- ⁷¹⁰ "2007 Census of Agriculture: Colorado State and County Data." *United States Department of Agriculture National Agricultural Statistics Service*. Table 63. December 2009.
http://www.agcensus.usda.gov/Publications/2007/Full_Report/Volume_1,_Chapter_1_State_Level/Colorado/cov1.pdf.
- ⁷¹¹ *Ibid.*
- ⁷¹² *Ibid.*
- ⁷¹³ *Ibid.*
- ⁷¹⁴ *Ibid.*
- ⁷¹⁵ *Ibid.*
- ⁷¹⁶ "2007 Census of Agriculture: Colorado State and County Data." *United States Department of Agriculture National Agricultural Statistics Service*. Table 50. December 2009.
http://www.agcensus.usda.gov/Publications/2007/Full_Report/Volume_1,_Chapter_1_State_Level/Colorado/cov1.pdf.
- ⁷¹⁷ "1987 Census of Agriculture." *United States Department of Agriculture*. Vol. 1. Geographic Area

- Series. Table 17. 1989.
- ⁷¹⁸ Ibid.
- ⁷¹⁹ “2007 Census of Agriculture: Colorado State and County Data.” *United States Department of Agriculture National Agricultural Statistics Service*. December 2009. http://www.agcensus.usda.gov/Publications/2007/Full_Report/Volume_1,_Chapter_1_State_Level/Colorado/cov1.pdf.
- ⁷²⁰ “2007 Census of Agriculture: Colorado State and County Data.” *United States Department of Agriculture National Agricultural Statistics Service*. Table 49. December 2009. http://www.agcensus.usda.gov/Publications/2007/Full_Report/Volume_1,_Chapter_1_State_Level/Colorado/cov1.pdf.
- ⁷²¹ “1950 Census of Agriculture.” *United States Department of Agriculture*. Vol. 1. Geographic Area Series. Table 5. 1952.
- ⁷²² “2007 Census of Agriculture: Colorado State and County Data.” *United States Department of Agriculture National Agricultural Statistics Service*. Table 46. [Selected Operation and Operator Characteristics: 2007 and 2002]. December 2009. http://www.agcensus.usda.gov/Publications/2007/Full_Report/Volume_1,_Chapter_1_State_Level/Colorado/cov1.pdf.
- ⁷²³ “2007 Census of Agriculture: Colorado State and County Data.” *United States Department of Agriculture National Agricultural Statistics Service*. Table 49. December 2009. http://www.agcensus.usda.gov/Publications/2007/Full_Report/Volume_1,_Chapter_1_State_Level/Colorado/cov1.pdf.
- ⁷²⁴ “1950 Census of Agriculture.” *United States Department of Agriculture*. Vol. 1. Geographic Area Series. Table 5. 1952.
- ⁷²⁵ Kandel, William. “Profile of Hired Farmworkers, A 2008 Update.” *United States Department of Agriculture, Economic Research Service*. 2008.
- ⁷²⁶ “Rural Labor and Education: Farm Labor.” *United States Department of Agriculture, Economic Research Service*. 2008. <http://www.ers.usda.gov/Briefing/LaborAndEducation/farmlabor.htm>
- ⁷²⁷ Ibid.
- ⁷²⁸ “National Agricultural Workers Survey.” *United States Department of Labor*. 2006.
- ⁷²⁹ “Profile of the Working Poor.” *United States Department of Labor*. Bureau of Labor Statistics. 2007. (Chart adapted from *State of the Rockies: 2009*)
- ⁷³⁰ “Profile of the Working Poor.” *United States Department of Labor*. Bureau of Labor Statistics. 2007.
- ⁷³¹ “Profile of the Working Poor.” *United States Department of Labor*. Bureau of Labor Statistics. 2007. (Chart adapted from *State of the Rockies: 2009*)
- ⁷³² “Rural Labor and Education: Farm Labor.” *United States Department of Agriculture, Economic Research Service*. 2008. <http://www.ers.usda.gov/Briefing/LaborAndEducation/farmlabor.htm>
- ⁷³³ Ibid.
- ⁷³⁴ Ibid.
- ⁷³⁵ Ibid.
- ⁷³⁶ “Farm and Ranch Irrigation Survey.” *U.S. Department of Agriculture (USDA) National Agricultural Statistics Service (NASS)*. Vol. 3, Special Studies, Part 1. 2003.
- ⁷³⁷ Ibid.
- ⁷³⁸ “2007 Census of Agriculture: Colorado State and County Data.” *United States Department of Agriculture National Agricultural Statistics Service*. Table 46. [Selected Operation and Operator

- Characteristics: 2007 and 2002.] December 2009.
http://www.agcensus.usda.gov/Publications/2007/Full_Report/Volume_1,_Chapter_1_State_Level/Colorado/cov1.pdf.
- ⁷³⁹ Ibid.
- ⁷⁴⁰ Truitt, Gary. "Ag Census Predicts Future by Looking at the Past." *Hoosier Ag Today*. 2009.
http://www.hoosieragtoday.com/wire/comments/00158_census_180833.php. (accessed July, 2009).
- ⁷⁴¹ Blankenau, Joe, Jon Bailey, and Julia Hudson. "The Causes and Consequences of the Rural Uninsured and Underinsured." *The Center for Rural Affairs*. Vol. 3. 2009.
<http://files.cfra.org/pdf/Causes-and-Consequences-of-Rural-Uninsured.pdf> (Accessed November 10, 2009).
- ⁷⁴² Alavanja, M.C.R., D. P. Sandler, C. F. Lynch, et al. "Cancer Incidence in the Agricultural Health Study." *Scand J Work Environ Health*, 31(S1): 39–45. 2005.
<http://dceg2.cancer.gov/pdfs/alavanja31392005.pdf>
- ⁷⁴³ Ibid.
- ⁷⁴⁴ Ibid.
- ⁷⁴⁵ Ibid.
- ⁷⁴⁶ Eriksson, M., L. Hardell, M. Carlberg, and M. Akerman. "Pesticide exposure as risk factor for non-Hodgkin lymphoma including histopathological subgroup analysis." *Int. J. Cancer*. 123:1657–1663. 2008.
- ⁷⁴⁷ Fortes, C., S. Mastroeni, F. Melchi, et al. "The association between residential pesticide use and cutaneous melanoma." *Eu.r. J Cancer*. 43: 1066–1075. 2007.
- ⁷⁴⁸ Merhi, M., H. Raynal, E. Cahuzac, et al. "Occupational exposure to pesticides and risk of hematopoietic cancers: metaanalysis of case-control studies." *Cancer Causes Control*. 18: 1209–1226. 2007.
- ⁷⁴⁹ Samanic, C.M., A.J. De Roos, P.A. Stewart, et al. "Occupational exposure to pesticides and risk of adult brain tumors." *Am. J. Epidemiol.* 167: 976–985. 2008.
- ⁷⁵⁰ Van Maele-Fabry, G., V. Libotte, J. Willems, D. Lison. "Review and meta-analysis of risk estimates for prostate cancer in pesticide manufacturing workers." *Cancer Causes Control*. 17: 353–373. 2006.
- ⁷⁵¹ Alavanja, M.C.R., D. P. Sandler, C. F. Lynch, et al. "Cancer Incidence in the Agricultural Health Study." *Scand J Work Environ Health*, 31(S1): 39–45. 2005.
<http://dceg2.cancer.gov/pdfs/alavanja31392005.pdf>
- ⁷⁵² "Number of fatal work injuries, 1992–2008." *US Bureau of Labor Statistics, US Department of Labor*. 2010. <http://www.bls.gov/iif/oshwc/foi/cfch0007.pdf>. Accessed March 31, 2010.
- ⁷⁵³ Liebman, Amy K. and W. Augustave. "Agricultural Health and Safety: Incorporating the Worker Perspective." *Journal of Agromedicine*. 15: 3, 192-199. 2010.
- ⁷⁵⁴ Aherin RA, D. J. Murphy, and J. D. Westaby. "Reducing farm injuries: issues and methods." *American Society of Agricultural Engineers*. 1992.
- ⁷⁵⁵ Zhou C, and J. M. Roseman. "Agricultural injuries among a population-based sample of farm operators in Alabama." *Am. J. Industrial. Med.* 25(3): 385-402. 1994.
- Stallones, L. "Surveillance of fatal and non-fatal farm injuries in Kentucky." *Am. J. Industrial Med.* 18(2): 223-234. 1990.
- Nordstrom, D.L., P.M. Layde, K.A. Olson, et al. "Fall-related occupational injuries on farms." *Am. J. Industrial Med.* 29(5): 509-515. 1996.

-
- Stallones, L., K.J. Keefe, and H. Y. Xiang. "Characteristics associated with increased farm-work related injuries among male resident farm operators in Colorado, 1993." *J. Agric. Safety and Health*. 3(3): 195-201. 1997.
- ⁷⁵⁶ Ibid.
- ⁷⁵⁷ "Number of fatal work injuries, 1992-2008." *US Bureau of Labor Statistics, US Department of Labor*. 2009. <http://www.bls.gov/iif/oshwc/foi/cfch0007.pdf>. Accessed March 31, 2010.
- ⁷⁵⁸ Hernandez-Peck, M. C. "Older Farmers: Factors Affecting Their Health and Safety". Washington, DC: *Centers for Disease Control and Prevention*. 2001.
- ⁷⁵⁹ Ibid.
- ⁷⁶⁰ "2007 Census of Agriculture: Colorado State and County Data." *United States Department of Agriculture National Agricultural Statistics Service*. Table 46. [Selected Operation and Operator Characteristics: 2007 and 2002] December 2009. http://www.agcensus.usda.gov/Publications/2007/Full_Report/Volume_1,_Chapter_1_State_Level/Colorado/cov1.pdf.
- ⁷⁶¹ "Traumatic Occupational Injuries: Agricultural Safety." *National Institute for Occupational Safety and Health*. 2004. <http://www.cdc.gov/niosh/injury/traumaagric.html>. Accessed November 12, 2004.
- ⁷⁶² "2001 Childhood Agricultural-Related Injuries." *National Agricultural Statistics Service (NASS): Fact Finders for Agriculture, United States Department of Agriculture*. 2004. <http://usda.mannlib.cornell.edu/usda/nass/ChilInju//2000s/2004/ChilInju-01-08-2004.pdf>

10. Human Health

- ⁷⁶³ Sobsey, M. D., L. A. Khatib, V. R. Hill, E. Alocilja, S. Pillai. "Pathogens in Animal Wastes and the Impacts of Waste Management Practices on Their Survival, Transport, and Fate." *National Center for Manure and Animal Waste Management*.
http://www.cals.ncsu.edu/waste_mgt/natlcenter/whitepapersummaries/pathogens.pdf Accessed on February 22, 2011
- ⁷⁶⁴ Ibid.
- ⁷⁶⁵ Overcash, M.R., F.J. Humenik, and J.R. Miner. *Livestock Waste Management*, Volumes I and II. Boca Raton, FL: CRC Press. 1983.
- ⁷⁶⁶ Kudva, I.T., K. Blanch, and C.J. Hovde. "Analysis of *Escherichia coli* O157:H7 survival in ovine and bovine manure and manure slurry." *Applied and Environmental Microbiology*. 64(9): 3166-3174. 1998.
- ⁷⁶⁷ "Pollution in America: An Emerging National Problem." Report compiled for Senator Tom Harkin. *U.S. Senate Committee on Agriculture, Nutrition and Forestry*. Animal Waste 105th Congress, 1st Session. December 1997.
- ⁷⁶⁸ Glasgow, H.B., J.M. Burkholder, D.E. Schmechel, P.A. Tester, P.A. Rublee. "Insidious effects of a toxic dinoflagellate on fish survival and human health." *J. Toxicol. Environ. Health*. 46: 501–522. 1995.
- ⁷⁶⁹ Tilman, David, K. G. Cassman, P. A. Matson, R. Naylor, and S. Polasky. "Agricultural sustainability and intensive production practices." *Nature*. Vol 418. 8 August 2002.
- ⁷⁷⁰ "The use of drugs in food animals: benefits and risks." National Academy of Sciences Committee on Drug Use in Food Animals. Washington, DC: *National Academy Press*. 1999.
- ⁷⁷¹ Mellon, M., C. Benbrook, K.L. Benbrook. "Hogging It: Estimates of Antimicrobial Abuse in Livestock." Cambridge, MA: *Union of Concerned Scientists*. 2001.
http://www.ucsusa.org/food_and_agriculture/science_and_impacts/impacts_industrial_agriculture/hogging-it-estimates-of.html
- ⁷⁷² Ibid.
- ⁷⁷³ "The Use of Drugs in Food Animals: Benefits and Risks." National Research Council and Institute of Medicine. Washington, DC: *National Academy Press*. 1999.
- ⁷⁷⁴ "Antibiotic Use in Food-Producing Animals Must Be Curtailed to Prevent Increased Resistance in Humans." Press Release WHO: 73. Geneva: *World Health Organization*. 20 October 1997.
- ⁷⁷⁵ "Toxicity of Pesticides." Pesticide Safety Fact Sheet. Pennsylvania State Agricultural Research and Cooperative Extension. 2006.
- ⁷⁷⁶ "LD50, 50% Lethal Dose Definition." Interactive Learning Paradigms Incorporated. *Safety Emporium*. 5 May 2010. <http://www.ilpi.com/msds/ref/ld50.html>
- ⁷⁷⁷ "Toxicity of Pesticides." Pesticide Safety Fact Sheet. Pennsylvania State Agricultural Research and Cooperative Extension. 2006.
- ⁷⁷⁸ "Draft Environmental Impact Statement: Glyphosate – Tolerant Alfalfa." United States Department of Agriculture. November 2009.
- ⁷⁷⁹ D.B. Barr, L.L. Needham, J. Chromatogr. B 778 (2005) 5.
- ⁷⁸⁰ Siebers, J., and R. Hanel. "Handbook of Residue Analytical Methods for Agrochemicals." Vol. 1, *John Wiley & Sons*, England. p. 13. 2003. [ftp://195.214.211.1/books/DVD-025/Lee_P.W._\(ed.\),_Aizawa_H._\(ed.\)_Handbook_of_Residue_Analytical_Methods_for_Agrochemicals_\(2003\)\(en\)\(1200s\).pdf](ftp://195.214.211.1/books/DVD-025/Lee_P.W._(ed.),_Aizawa_H._(ed.)_Handbook_of_Residue_Analytical_Methods_for_Agrochemicals_(2003)(en)(1200s).pdf)

- ⁷⁸¹ Repetto, R., S.S. Baliga. "Pesticides and the Immune System: The Public Health Risks." Washington, DC: *World Resources Institute*. 1996.
- ⁷⁸² Blair, A., S.H. Zahm. "Agricultural exposures and cancer." *Environ. Health Perspect.* 103 (suppl 8): 205–208. 1995.
- ⁷⁸³ Ibid.
- ⁷⁸⁴ Margni, M., D. Rossier, P. Crettaz, O. Jolliet. "Life cycle impact assessment of pesticides on human health and ecosystems." *Agriculture, Ecosystems and Environment*, 93: 379–392. 2001.
- ⁷⁸⁵ Ibid.
- ⁷⁸⁶ Jolliet, O., M. Margni, D. Rossier, P. Crettaz. 1998. "Life cycle impact assessment of pesticides on human health and ecosystems." Proceedings of the VTO Conference on Life Cycle Assessment in *Agriculture, Agroindustry and Forestry*. Brussels. 3-4 December 1998, pp. 109-119.
- ⁷⁸⁷ Margni, M., D. Rossier, P. Crettaz, O. Jolliet. "Life cycle impact assessment of pesticides on human health and ecosystems." *Agriculture, Ecosystems and Environment*, 93: 379–392. 2001.
- ⁷⁸⁸ Kaushik, Geetanjali, S. Satya, and S.N. Naik. "Food processing a tool to pesticide residue dissipation – A review." *Center for Rural Development and Technology, Indian Institute of Technology Delhi*, New Delhi 110016, India. *Food Research International* 42: 26-40. 2009.
- ⁷⁸⁹ Domingo, J.L. "Health risks of GM foods: many opinions but few data." *Science* 288: 1748–1749. 2000.
- ⁷⁹⁰ Meningaud, J.P., G. Moutel, C. Herve. "Ethical acceptability, health policy, and foods biotechnology based foods: is there a third way between the precaution principle and on overly enthusiastic dissemination of GMO?" *Med Law* 20:133–141. 2001.
- ⁷⁹¹ Séralini, Gilles-Eric, Dominique Cellier and Joël Spiroux de Vendomois. "New Analysis of a Rat Feeding Study with a Genetically Modified Maize Reveals Signs of Hepatorenal Toxicity." *Environmental Contamination and Toxicology*.
- ⁷⁹² "Safety of Genetically Engineered Foods: Approaches to Assessing Unintended Health Effects. Report in Brief." *National Academy of Science*. July 2004.
- ⁷⁹³ Ibid.
- ⁷⁹⁴ Ibid.
- ⁷⁹⁵ Sampson, H.A. "Update on food allergy." *J. Allergy Clin. Immunol.* 113: 805–19. 2004.
- ⁷⁹⁶ Sampson, H.A. "Food allergy. Part 1: immunopathogenesis and clinical disorders." *J. Allergy Clin. Immunol.* 103: 717–728. 1999.
- ⁷⁹⁷ Sicherer, S.H. "Food allergy." *Lancet.* 360: 701–10. 2002.
- ⁷⁹⁸ Branum, A.M. and S.L. Lukacs. "Food allergy among U.S. children: Trends in prevalence and hospitalizations." NCHS data brief, no 10. Hyattsville, MD: *National Center for Health Statistics*. 2008. <http://cdc.gov/nchs/data/databriefs/db10.pdf>
- ⁷⁹⁹ Sampson, H.A. "Food allergy. Part 1: immunopathogenesis and clinical disorders." *J. Allergy Clin. Immunol.* 103: 717–728. 1999.
- ⁸⁰⁰ Burks, A.W. and H.A. Sampson. "Food allergies in children." *Curr. Probl. Pediatr.* 23: 230–252. 1993.
- ⁸⁰¹ Hefle, S.L., J.A. Nordlee, and S.L. Taylor. "Allergenic foods." *Crit. Rev. Food Sci. Nutr.* 36(Suppl.): S69–S89. 1996.

- ⁸⁰² A. Pusztai, Susan Bardocz, and Stanley W.B. Ewen. "Genetically Modified Foods: Potential Human Health Effects," *Food Safety: Contaminants and Toxins*. (Wallingford Oxon, UK: CAB International), 347–372. April 2003.
- ⁸⁰³ Lehrer, S. B. and G. A. Bannon. "Risks of allergic reactions to biotech proteins in foods: perception and reality." Article first published online: 6 APR 2005 DOI: 10.1111/j.1398-9995.2005.00704.x. *Allergy*. Vol 60, Issue 5, pages 559–564, May 2005
<http://onlinelibrary.wiley.com/doi/10.1111/all.2005.60.issue-5/issuetoc>
- ⁸⁰⁴ "Safety of Genetically Engineered Foods: Approaches to Assessing Unintended Health Effects. Report in Brief." *National Academy of Science*. July 2004.
- ⁸⁰⁵ Nordlee, J.A., S.L. Taylor, J.A. Townsend, and L.A. Thomas. "Identification of a Brazil nut allergen in transgenic soybean." *New England Journal of Medicine*. 334, 688-692. 1996.
- ⁸⁰⁶ Bindslev-Jensen, C. and Poulsen, L.K. (1997) Hazards of unintentional/intentional introduction of allergens into foods. *Allergy* 52, 1184-1186.
- ⁸⁰⁷ Helm, R.M. and Burks, A.W. (2000) Mechanisms of food allergy. *Current Opinion in Immunology* 12, 647-653.
- ⁸⁰⁸ A. Pusztai, Susan Bardocz, and Stanley W.B. Ewen. "Genetically Modified Foods: Potential Human Health Effects," *Food Safety: Contaminants and Toxins*. (Wallingford Oxon, UK: CAB International), 347–372. April 2003.
- ⁸⁰⁹ "Evaluation of Allergenicity of Genetically Modified Foods Report of a Joint FAO/WHO Expert Consultation on Allergenicity of Foods Derived from Biotechnology." 22-25. *Food and Agriculture Organization of the United Nations (FAO)*. Rome, Italy. January 2001.
- ⁸¹⁰ Prescott, Vanessa E., Peter M. Campbell, Andres Moore, et al. "Transgenic Expression of Bean α -Amylase Inhibitor in Peas Results in Altered Structure and Immunogenicity." *J. Agric. Food Chem.* 53, 9023–9030. 2005.
- ⁸¹¹ Goodman, Richard E., Stefan Vieths, Hugh A Sampson, et al. "Allergenicity assessment of genetically modified crops—what makes sense?" *Nature Biotechnology*. Vol. 26. No 1. January 2008
- ⁸¹² "Genetically modified mush." *Nat. Biotechnol.* 24(2): 2006. [No authors listed.]
- ⁸¹³ Codex Alimentarius Commission. Alinorm 03/34: Joint FAO/WHO Food Standard Programme, Codex Alimentarius Commission, Twenty-Fifth Session, Rome, 30 June–5 July, 2003. Appendix III, Guideline for the conduct of food safety assessment of foods derived from recombinant-DNA plants and Appendix IV, Annex on the assessment of possible allergenicity, pp. 47–60 (2003).
- ⁸¹⁴ Prescott, Vanessa E., Peter M. Campbell, Andrew Moore, et al. "Transgenic Expression of Bean α -Amylase Inhibitor in Peas Results in Altered Structure and Immunogenicity" *Journal of Agricultural and Food Chemistry*. Vol. 53: Issue 23 pages 9023 – 9030. November 16, 2005.
- ⁸¹⁵ Astwood, James D., Gary A. Bannon, Raymond L. Dobert, and Roy L. Fuchs. "Food Biotechnology and Genetic Engineering." *Food Allergy: Adverse Reactions to Food and Food Additives*. 2003, 51-71.
http://books.google.com/books?hl=en&lr=&id=IDUWKkgqwy0C&oi=fnd&pg=PA51&dq=Food+biotechnology+and+genetic+engineering&ots=_PC-nYIsZY&sig=f6kcvYPyYhDqT7cmRiC4tuLt6tw#v=onepage&q=Food%20biotechnology%20and%20genetic%20engineering&f=false
- ⁸¹⁶ Lehrer, S. B. and G. A. Bannon "Risks of allergic reactions to biotech proteins in foods: perception and reality." *Allergy*. Volume 60, Issue 5, pages 559–564, May 2005.
- ⁸¹⁷ Batista, Rita, B. S. Baltazar Nunes, M. S. Manuela Carmo, et al. "Lack of detectable allergenicity of transgenic maize and soya samples." *J. Allergy Clin. Immunol.* August 2005

- ⁸¹⁸ Sutton, S.A., A.H. Assa'ad, C. Steinmetz, and M.E. Rothenberg. "A negative, double-blind, placebo-controlled challenge to genetically modified corn." *J. Allergy Clin. Immunol.* 112: 1011–1012. CrossRef, PubMed, Web of Science®. 2003.
<http://onlinelibrary.wiley.com/resolve/reference/PMED?id=14610498>
- ⁸¹⁹ Taylor, S.L. "Review of the development of methodology for evaluating the human allergenic potential of novel proteins." *Mol. Nutr. Food Res.* 50, 604–609. 2006.
- ⁸²⁰ A. Pusztai, Susan Bardocz, and Stanley W.B. Ewen. "Genetically Modified Foods: Potential Human Health Effects," *Food Safety: Contaminants and Toxins.* (Wallingford Oxon, UK: CAB International), 347–372. April 2003.
- ⁸²¹ "Evaluation of Allergenicity of Genetically Modified Foods Report of a Joint FAO/WHO Expert Consultation on Allergenicity of Foods Derived from Biotechnology." 22-25. *Food and Agriculture Organization of the United Nations (FAO)*. Rome, Italy. January 2001.
- ⁸²² Lehrer, S. B. and G. A. Bannon. "Risks of allergic reactions to biotech proteins in foods: perception and reality." Article first published online: 6 APR 2005. DOI: 10.1111/j.1398-9995.2005.00704.x. *Allergy*. Vol. 60. Issue 5, pages 559–564. May 2005.
<http://onlinelibrary.wiley.com/doi/10.1111/all.2005.60.issue-5/issuetoc>
- ⁸²³ A. Pusztai, Susan Bardocz, and Stanley W.B. Ewen. "Genetically Modified Foods: Potential Human Health Effects," *Food Safety: Contaminants and Toxins.* (Wallingford Oxon, UK: CAB International), 347–372. April 2003.
- ⁸²⁴ "Safety of Genetically Engineered Foods: Approaches to Assessing Unintended Health Effects. Report in Brief." *National Academy of Science*. July 2004.

11. Local Economy

- ⁸²⁵ “2007 Census of Agriculture: State Profile: Colorado.” *United States Department of Agriculture National Agricultural Statistics Service*. 4 February 2009.
http://www.agcensus.usda.gov/Publications/2007/Online_Highlights/County_Profiles/Colorado/cp99008.pdf
- ⁸²⁶ “Data Sets: State Fact Sheets: Colorado.” United States Department of Agriculture Economic Research Service. 16 December 2010. <http://www.ers.usda.gov/statefacts/co.htm#FC>
- ⁸²⁷ “2007 Census of Agriculture: State Profile: Colorado.” *United States Department of Agriculture National Agricultural Statistics Service*. 4 February 2009.
http://www.agcensus.usda.gov/Publications/2007/Online_Highlights/County_Profiles/Colorado/cp99008.pdf
- ⁸²⁸ Hoppe, Robert A. “Farm Structure: Declining – But Persistent Small Commercial Farms.” *Amber Waves*. USDA. September 2010.
<http://www.ers.usda.gov/AmberWaves/September10/Features/USFarm.htm>
- ⁸²⁹ “2007 Census of Agriculture: Colorado State and County Data.” *United States Department of Agriculture National Agricultural Statistics Service*. December 2009.
http://www.agcensus.usda.gov/Publications/2007/Full_Report/Volume_1,_Chapter_1_State_Level/Colorado/cov1.pdf.
- ⁸³⁰ Hoppe, Robert A. “U.S. Farm Structure: Declining – But Persistent – Small Commercial Farms.” *Amber Waves: The Economics of Food, Farming, Natural Resources, and Rural America*. September 2010. <http://www.ers.usda.gov/AmberWaves/September10/Features/USFarm.htm>
- ⁸³¹ Ibid.
- ⁸³² Ibid.
- ⁸³³ “2007 Census of Agriculture: Colorado State and County Data.” *United States Department of Agriculture National Agricultural Statistics Service*. December 2009.
http://www.agcensus.usda.gov/Publications/2007/Full_Report/Volume_1,_Chapter_1_State_Level/Colorado/cov1.pdf.
- ⁸³⁴ Ibid.
- ⁸³⁵ Ibid.
- ⁸³⁶ Hoppe, Robert A. “U.S. Farm Structure: Declining – But Persistent – Small Commercial Farms.” *Amber Waves: The Economics of Food, Farming, Natural Resources, and Rural America*. September 2010. <http://www.ers.usda.gov/AmberWaves/September10/Features/USFarm.htm>
- ⁸³⁷ Ibid.
- ⁸³⁸ “Farm Costs and Returns Survey (1988-95) and Agricultural Resource management Survey (1996-2004).” *Economic Research Service*. Graphic can be viewed at: “Farm Family Income.” *U.S. Department of Agriculture (USDA)*. www.usda.gov/documents/FARM_FAMILY_INCOME.doc
- ⁸³⁹ Hoppe, Robert A. “U.S. Farm Structure: Declining – But Persistent – Small Commercial Farms.” *Amber Waves: The Economics of Food, Farming, Natural Resources, and Rural America*. September 2010. <http://www.ers.usda.gov/AmberWaves/September10/Features/USFarm.htm>
- ⁸⁴⁰ “2007 Census of Agriculture: Colorado State and County Data.” *United States Department of Agriculture National Agricultural Statistics Service*. December 2009.
http://www.agcensus.usda.gov/Publications/2007/Full_Report/Volume_1,_Chapter_1_State_Level/Colorado/cov1.pdf.
- ⁸⁴¹ Ibid.

- 842 Thorvaldson, J. and J. Pritchett. "Profile of the South Platte River Basin." *Department of Agricultural and Resource Economics Economic Development Report*. EDR 05-03. December 2005. <http://dare.colostate.edu/pubs/extension.aspx>
- 843 Ibid.
- 844 Ibid.
- 845 Ibid.
- 846 Ibid.
- 847 Ibid.
- 848 Ibid.
- 849 Howe, C.W. and C. Goemans. "Water Transfers and Their Impacts: Lessons from Three Colorado Water Markets." *Journal of the American Water Resources Association*. 1055-1065. October 2003. <http://www.kysq.org/docs/HoweGoemans.pdf>
- 850 Ibid.
- 851 Ibid.
- 852 Houk, E., M. Frasier, and R.G. Taylor. "Evaluating Water Transfers from Agriculture for Reducing Critical Habitat Water Shortages in the Platte Basin." *Journal of Water Resources Planning and Management*. Vol. 133: No. 4. 320-328. July/August 2007. <http://cedb.asce.org/cgi/WWWdisplay.cgi?159222>
- 853 Ibid.
- 854 "Alternative Agricultural Transfer Methods Grant Program Summary of Key Issues Evaluation." Colorado Water Conservation Board. July 2010. <http://cwcb.state.co.us/LoansGrants/alternative-agricultural-water-transfer-methods-grants/Documents/AltAgTransferMethodsGrantProgramSummKeyIssuesDraftTechMemo.pdf>
- 855 Thorvaldson, J., J. Pritchett, A. Jha, and N. Hansen. "Water Leasing: Opportunities and Challenges for Colorado's South Platte Basin." *Department of Agriculture and Resource Economics' Production and Farm Management Report*. PFMR 08-02. September 2008. <http://dare.colostate.edu/pubs/extension.aspx>
- 856 "Ag Water Conservation Policy." Agricultural Water Conservation Clearinghouse. 2009 http://www.agwaterconservation.colostate.edu/FAQs_AGWATERCONSERVATIONPOLICY.aspx
- 857 "Colorado's Water Future: Executive Summary for the DU Water Futures Panel." University of Denver. 2007.
- 858 Thorvaldson, J., J. Pritchett, A. Jha, and N. Hansen. "Water Leasing: Opportunities and Challenges for Colorado's South Platte Basin." *Department of Agriculture and Resource Economics' Production and Farm Management Report*. PFMR 08-02. September 2008. <http://dare.colostate.edu/pubs/extension.aspx>
- 859 Ibid.
- 860 Ibid.
- 861 Coupal, R. and A. Seidl. "Rural Land Use and Your Taxes: The Fiscal Impact of Rural Residential Development in Colorado." *Department of Agriculture and Resource Economics Land Use and Planning Report*. LUPR 03-02. March 2003. <http://dare.colostate.edu/pubs/extension.aspx>
- 862 Ibid.
- 863 Thilmany, D.D. "Colorado Crop to Cuisine." *Review of Agricultural Economics*. Vol. 26: No. 3. 404-416. 2004. <http://www.jstor.org/pss/3700810>



- ⁸⁶⁴ Starr, A., A. Card, C. Benepe, G. Auld, D. Lamm, K. Smith, and K. Wilken. "Sustaining Local Agriculture: Barriers and Opportunities to Direct Marketing Between Farms and Restaurants in Colorado." *Agriculture and Human Values*. Vol. 20: 301-321. 2003.
<http://www.trabal.org/texts/foodlinksfinalarticle.pdf>
- ⁸⁶⁵ Ibid.
- ⁸⁶⁶ Ibid.
- ⁸⁶⁷ Ibid.
- ⁸⁶⁸ "2007 Census of Agriculture: Colorado State and County Data." *United States Department of Agriculture National Agricultural Statistics Service*. December 2009.
http://www.agcensus.usda.gov/Publications/2007/Full_Report/Volume_1,_Chapter_1_State_Level/Colorado/cov1.pdf.
- ⁸⁶⁹ "Data Sets: Organic Production." *United States Department of Agriculture*. 14 September 2010.
<http://www.ers.usda.gov/Data/Organic/>
- ⁸⁷⁰ Greene, Catherine and Amy Kremen. "U.S. Organic Farming in 2000-2001: Adoption of Certified Systems." *Agriculture Information Bulletin No. 780*. (February 2003)
<http://www.ers.usda.gov/publications/aib780/aib780.pdf>
- ⁸⁷¹ "2007 Census of Agriculture: Colorado State and County Data." *United States Department of Agriculture National Agricultural Statistics Service*. December 2009.
http://www.agcensus.usda.gov/Publications/2007/Full_Report/Volume_1,_Chapter_1_State_Level/Colorado/cov1.pdf.
- ⁸⁷² Sherwood, K. "Overview Section: Land and Water – Common Ground for Competing Uses." *The 2010 Colorado College State of the Rockies Report Card*. April 2010.
<http://www.coloradocollege.edu/stateoftherockies/reportcard.html>

Glossary of Terms

- ⁸⁷³ Fernandez-Cornejo, Jorge, and William D. McBride, "Genetically Engineered Crops for Pest Management in U.S. Agriculture: Farm-Level Effects." *United States Department of Agriculture Economic Research Service*. April 2000. <http://www.ers.usda.gov/publications/AER786/>.
- ⁸⁷⁴ Senseagent. "Roughness Length". (2011)
<http://dictionary.senseagent.com/roughness+length/en-en/>
- ⁸⁷⁵ "Glossary: Agroecology." *USDA National Agricultural Library*.
<http://agclass.nal.usda.gov/mtwdk.exe?k=glossary&l=60&w=225&n=1&s=5&t=2> Accessed on 14 December 2010.
- ⁸⁷⁶ "About Agroforestry." *National Agroforestry Center, USDA*. <http://www.unl.edu/nac/index.htm>, accessed on February 25, 2010
- ⁸⁷⁷ Budikova, D. and C. Michael Hogan. "Albedo". *The Encyclopedia of the Earth*. 26 January 2011. <http://www.eoearth.org/article/Albedo?topic=54300>
- ⁸⁷⁸ USDA Sustainable Agriculture: Definitions & Terms
<http://www.nal.usda.gov/afsic/pubs/terms/srb9902terms.shtml>.
- ⁸⁷⁹ Bioconcentration Definitions. *U.S. Geological Survey (USGS)*. (2010).
<http://toxics.usgs.gov/definitions/bioconcentration.html>
- ⁸⁸⁰ "Toxicology Glossary." *U.S. National Library of Medicine. U.S. Department of Health and Human Services*. 1 December 2005. <http://sis.nlm.nih.gov/enviro/glossaryb.html>
- ⁸⁸¹ Integrated Pest Management Tools. *University of Massachusetts Amherst*. (2010).
http://www.umassgreeninfo.org/fact_sheets/ipmtools/biorationals.html.
- ⁸⁸² "Sewage Sludge (Biosolids): Introduction." *United States Environmental Protection Agency*. 2010.
<http://water.epa.gov/polwaste/wastewater/treatment/biosolids/index.cfm>
- ⁸⁸³ Soil Survey of Boulder County Area, Colorado. *National Cooperative Soil Survey (NCSS)*.
- ⁸⁸⁴ Fernandez-Cornejo, Jorge, and William D. McBride, "Genetically Engineered Crops for Pest Management in U.S. Agriculture: Farm-Level Effects." *United States Department of Agriculture Economic Research Service*. April 2000. <http://www.ers.usda.gov/publications/AER786/>
- ⁸⁸⁵ Ibid.
- ⁸⁸⁶ Ibid.
- ⁸⁸⁷ Scherer, Thomas F. "Irrigation water pumps." *North Dakota State University Extension*. April 1993. <http://www.ag.ndsu.edu/pubs/ageng/irrigate/ae1057w.htm>.
- ⁸⁸⁸ Soil Survey of Boulder County Area, Colorado. *National Cooperative Soil Survey (NCSS)*.
- ⁸⁸⁹ Eicher, Annie. "Organic Program Coordinator." *University of California Cooperative Extension*. February 2003. <http://ucce.ucdavis.edu/files/filelibrary/1068/8286.pdf> Accessed on February 25, 2010.
- ⁸⁹⁰ "Irrigation Glossary." *Washington State University*. 2011.
<http://irrigation.wsu.edu/Content/Resources/Irrigation-Glossary.php#c>
- ⁸⁹¹ Soil Survey of Boulder County Area, Colorado. *National Cooperative Soil Survey (NCSS)*.
- ⁸⁹² Sullivan, Preston "Overview of Cover Crops and Green Manures." *National Sustainable Agriculture Information Service*. Published 2003 NCAT. <http://attra.ncat.org/attra-pub/covercrop.html#principal> Accessed March 2011.

- ⁸⁹³ Watson, Ben. "Hybrid or Open Pollinated." *National Gardening Association*.
<http://www.garden.org/subchannels/care/seeds?q=show&id=293> Accessed on March 2011.
- ⁸⁹⁴ Ritter, Michael E. "The Physical Environment: an Introduction to Physical Geography." October 2009. http://www.uwsp.edu/geo/faculty/ritter/geog101/textbook/title_page.html.
- ⁸⁹⁵ "Organic Diets for Small Poultry Flocks." *Manitoba*.
<http://www.gov.mb.ca/agriculture/livestock/poultry/bba01s20.html>.
- ⁸⁹⁶ *Cornell University Ecoagriculture Working Group*. 2009. <http://ecoag.cals.cornell.edu/>
- ⁸⁹⁷ "Safety of Genetically Engineered Foods: Approaches to Assessing Untended Health Effects: Endogenous Allergens." *National Research Council and Institute of Medicine (U.S.) The National Academies Press: Washington D.C.* 2004.
- ⁸⁹⁸ Lehrer, S. B. and G. A. Bannon. "Risks of allergic reactions to biotech proteins in foods: perception and reality." Article first published online: 6 APR 2005 DOI: 10.1111/j.1398-9995.2005.00704.x. *Allergy*. Vol 60, Issue 5, pages 559–564, May 2005
<http://onlinelibrary.wiley.com/doi/10.1111/all.2005.60.issue-5/issuetoc>
- ⁸⁹⁹ "Glossary: Eutrophication." *USDA National Agricultural Library*.
<http://agclass.nal.usda.gov/mtwdk.exe?k=glossary&l=60&w=2330&n=1&s=5&t=2>. Accessed on 14 December 2010.
- ⁹⁰⁰ Hanson, R.L. "Evapotranspiration and Droughts." in Paulson, R.W., Chase, E.B., Roberts, R.S., and Moody, D.W. Compilers. National Water Summary 1988-89--Hydrologic Events and Floods and Droughts: *U.S. Geological Survey Water-Supply Paper 2375*, p. 99-104. 1991. Accessed on March 2011. <http://geochange.er.usgs.gov/sw/changes/natural/et/>
- ⁹⁰¹ Soil Survey of Boulder County Area, Colorado. *National Cooperative Soil Survey (NCSS)*.
- ⁹⁰² Ibid.
- ⁹⁰³ Fernandez-Cornejo, Jorge, and William D. McBride, "Genetically Engineered Crops for Pest Management in U.S. Agriculture: Farm-Level Effects." *United States Department of Agriculture Economic Research Service*. April 2000. <http://www.ers.usda.gov/publications/AER786/>.
- ⁹⁰⁴ "Glossary: Genetic Engineering." *USDA National Agricultural Library*.
<http://agclass.nal.usda.gov/mtwdk.exe?k=glossary&l=60&w=2891&n=1&s=5&t=2>. Accessed on 14 December 2010.
- ⁹⁰⁵ "Pesticide Information Project." *Cooperative Extension Offices of Cornell University, Michigan State University, Oregon State University, and University of California at Davis*.
<http://pmep.cce.cornell.edu/profiles/extoxnet/dienochlor-glyphosate/glyphosate-ext.html>
 Accessed on February 25, 2010
- ⁹⁰⁶ Colorado State University Extension. September 2008.
<http://www.extension.org/pages/16597/green-chop>
- ⁹⁰⁷ Sullivan, Preston. "Overview of Cover Crops and Green Manures." *National Sustainable Agriculture Information Service*. Published 2003 NCAT. <http://attra.ncat.org/attra-pub/covercrop.html#principal> Accessed March, 2011
- ⁹⁰⁸ Ingham, E. R. "Soil Biology." *USDA/Natural Resources Conservation Service*.
http://soils.usda.gov/sqi/concepts/soil_biology/soil_food_web.html.
- ⁹⁰⁹ "Roundup Ready® - Sugar Beet H7-1." *Monsanto - KWS SAAT AG*. October, 2007.
http://www.google.com/url?sa=t&source=web&cd=16&ved=0CDUQFjAFOAo&url=http%3A%2F%2Fwww.kws.de%2Fglobal%2Fshow_document.asp%3Fid%3Daaaaaaaaaaeukul%26download%3D1&rct=j&q=H7%E2%80%901%20sugar%20beets&ei=oV5-TfKfEtL6rAHm4MiHBg&usq=AFQjCNEB1N6yDTEly4IGxUAXPWDD28aMjA&sig2=t8-xTyw0hD9_YCM9mDQBvQ&cad=rja



- ⁹¹⁰ "Indirect Energy and Your Wallet." AEI Outlook Series. *American Enterprise Institute For Public Policy Research*. <http://www.aei.org/outlook/100017> Accessed on February, 25 2010
- ⁹¹¹ "Life-Cycle Assessment (LCA)." *National Risk Management Research Laboratory*. <http://www.epa.gov/nrmrl/lcaccess/>, accessed on February 25, 2010
- ⁹¹² Singer, Jeremy. "Legume Living Mulches in Corn and Soybean." *Iowa State University Extension*. August 2005. <http://www.extension.iastate.edu/Publications/PM2006.pdf>.
- ⁹¹³ "Sustainable Agriculture: Definitions & Terms." *USDA National Agricultural Library*. August 2007. <http://www.nal.usda.gov/afsic/pubs/terms/srb9902terms.shtml>.
- ⁹¹⁴ "Glossary: Continuous Cropping." *U.S. Department of Agriculture National Agricultural Library*. [a search of monoculture brought up "use continuous cropping."] <http://agclass.nal.usda.gov/mtwdk.exe?k=glossary&l=60&w=1513&n=1&s=5&t=2> Accessed on February 25, 2010.
- ⁹¹⁵ "National Organic Program." *United States Department of Agriculture, Agricultural Marketing Services*. 2011. <http://www.ams.usda.gov/AMSv1.0/nop> Accessed on February 25, 2010.
- ⁹¹⁶ "Sustainable Agriculture: Definitions & Terms." *USDA National Agricultural Library*. August 2007. <http://www.nal.usda.gov/afsic/pubs/terms/srb9902terms.shtml>.
- ⁹¹⁷ Denninger, Corey, Yassert Gonzalez. "Estimating Net Irrigation Requirement (NIR) for Utility Service Areas using ModelBuilder." *Southwest Florida Water Management District*. http://proceedings.esri.com/library/userconf/serug08/papers/user/water/1/estima_1.pdf
- ⁹¹⁸ Ascough II, J., D. Hoag, and J. Popp. "Targeting soil-conservation policies for sustainability: New empirical evidence." *Journal of Soil and Water Conservation* 57(2): 66-74. March/April 2002. <http://0-proquest.umi.com/bianca.penlib.du.edu/pqdweb?index=0&did=132746331&SrchMode=1&sid=1&Fmt=6&VInst=PROD&VType=PQD&RQT=309&VName=PQD&TS=1291922754&clientId=48347>.
- ⁹¹⁹ "NOAA's State of the Coast: Glossary." *National Oceanic and Atmospheric Administration*. 2010. <http://stateofthecoast.noaa.gov/glossary.html>
- ⁹²⁰ Watson, Ben. "Hybrid or Open Pollinated." *National Gardening Association*. <http://www.garden.org/subchannels/care/seeds?q=show&id=293> Accessed on March 2011.
- ⁹²¹ "Sustainable Agriculture: Definitions & Terms." *USDA National Agricultural Library*. August 2007. <http://www.nal.usda.gov/afsic/pubs/terms/srb9902terms.shtml>.
- ⁹²² "Hydrologic Cycle." *Northwest River Forecast Center*. http://www.nwrfc.noaa.gov/info/water_cycle/hydrology.cgi Accessed on March 2011.
- ⁹²³ "Sustainable Agriculture: Definitions & Terms." *USDA National Agricultural Library*. August 2007. <http://www.nal.usda.gov/afsic/pubs/terms/srb9902terms.shtml>.
- ⁹²⁴ "Permeability." *Michigan Tech University: Environmental Education Curriculum Groundwater Supply*. <http://techalive.mtu.edu/meec/module06/Permeability.htm>
- ⁹²⁵ "Control of Water Pollution by Agriculture: Chapter 2. Pollution by Sediments." *FAO Corporate Document Repository*. 2011. <http://www.fao.org/docrep/w2598e/w2598e05.htm>
- ⁹²⁶ Knebusch, Kurt. "Polyculture 'Modules' for Small Farms, Suburbia: Fewer Pests, \$90,000 an Acre?" *Ohio State University*. <http://www.ag.ohio-state.edu/~news/story.php?id=3379> Accessed on February 25, 2010.
- ⁹²⁷ "Potash: Statistics and Information." *U.S. Geological Survey*. January 2011. <http://minerals.usgs.gov/minerals/pubs/commodity/potash/>.

- ⁹²⁸ "What is Precision Agriculture?" *Precision Agriculture Center*. Modified January 29th, 2007. <http://www.precision.agri.umn.edu/education.shtml> accessed on March 11, 2011
- ⁹²⁹ Progeny. Dictionary.com. *Dictionary.com Unabridged*. Random House, Inc. <http://dictionary.reference.com/browse/progeny> accessed: March 11, 2011.
- ⁹³⁰ Ritter, Michael E. "The Physical Environment: an Introduction to Physical Geography." September 2006. http://www.uwsp.edu/geo/faculty/ritter/glossary/S_U/salinization.html.
- ⁹³¹ Watson, Ben. "Hybrid or Open Pollinated." *National Gardening Association*. <http://www.garden.org/subchannels/care/seeds?q=show&id=293> Accessed on March 2011.
- ⁹³² Ess, Daniel R. Stephen E. Hawkins, D Keith Morris. "Implementing Site-Specific Management: Liquid Manure Application." *Precision Agriculture*. Purdue University. <http://www.extension.purdue.edu/extmedia/AE/SSM-1-W.pdf> Accessed on February 25, 2010.
- ⁹³³ Soil Survey of Boulder County Area, Colorado. *National Cooperative Soil Survey (NCSS)*.
- ⁹³⁴ "Stecklings: Definition." *Agricultural Dictionary*. <http://www.agriculturedictionary.com/definition/stecklings.html>
- ⁹³⁵ "Glossary: Strip Cropping." *USDA National Agricultural Library*. <http://agclass.nal.usda.gov/mtwdk.exe?k=glossary&l=60&w=6091&n=1&s=5&t=2> Accessed on 14 December 2010.
- ⁹³⁶ Soil Survey of Boulder County Area, Colorado. *National Cooperative Soil Survey (NCSS)*.
- ⁹³⁷ Ascough II, J., D. Hoag, and J. Popp. "Targeting soil-conservation policies for sustainability: New empirical evidence." *Journal of Soil and Water Conservation* 57(2): 66-74. March/April 2002. <http://0-proquest.umi.com/bianca.penlib.du.edu/pqdweb?index=0&did=132746331&SrchMode=1&sid=1&Fmt=6&VInst=PROD&VType=PQD&RQT=309&VName=PQD&TS=1291922754&clientId=48347>.
- ⁹³⁸ "Sustainable Agriculture: Definitions and Terms." *United States Department of Agriculture National Agricultural Library*. Special Reference Brief Series no. SRB 99-02. 1999. <http://www.nal.usda.gov/afsic/pubs/terms/srb9902.shtml#toc4>
- ⁹³⁹ "Glossary: Sustainable Agriculture." *USDA National Agricultural Library*. <http://agclass.nal.usda.gov/mtwdk.exe?k=glossary&l=60&w=6146&n=1&s=5&t=2> Accessed on 14 December 2010.
- ⁹⁴⁰ Food, Agriculture, Conservation, and Trade Act of 1990 (FACTA), Public Law 101-624, Title XVI, Subtitle A, Section 1603 (Government Printing Office, Washington, DC, 1990) NAL Call # KF1692.A31 1990]
- ⁹⁴¹ "Sustainable Agriculture." *Scientific Certification Systems*. http://www.scscertified.com/fff/sustainable_agriculture.php
- ⁹⁴² "SCS Sustainable Agriculture Practice Standard." *Scientific Certification Systems*. Version 1.1 August 20, 2009. http://www.scscertified.com/docs/SCS_STN_SustainAgStandard_V1-1_082009.pdf
- ⁹⁴³ "Sustainable Agriculture." *Scientific Certification Systems*. http://www.scscertified.com/fff/sustainable_agriculture.php
- ⁹⁴⁴ "Toxicology Glossary." U.S. National Library of Medicine. *U.S. Department of Health and Human Services*. 1 December 2005. <http://sis.nlm.nih.gov/enviro/glossaryb.html>
- ⁹⁴⁵ Whiting, David, Adrian Card, Carl Wilson, et al. "Managing Soil Tilth." Colorado Master Gardener Program, Colorado Master Certificate Training, Colorado State University Extension, <http://www.cmg.colostate.edu/gardennotes/213.pdf>



-
- ⁹⁴⁶ "Hydrologic Cycle." *Northwest River Forecast Center*.
http://www.nwrfc.noaa.gov/info/water_cycle/hydrology.cgi Accessed on March 2011.
- ⁹⁴⁷ Murphy, S. "General Information on Turbidity." City of Boulder/USGS Water Quality Monitoring.
<http://bcn.boulder.co.us/basin/data/NEW/info/Turb.html>.
- ⁹⁴⁸ "Introduction to Prescription Maps for Variable-rate Application." *Alabama Cooperative Extension System. Alabama A&M and Auburn Universities*. <http://www.aces.edu/pubs/docs/A/ANR-1362/ANR-1362.pdf?PHPSESSID=291b6b396978b1e620c98e0a46a5325c> Accessed on February 25, 2010
- ⁹⁴⁹ Dickerson, George W. "Vermicomposting." *Cooperative Extension Service, College of Agriculture and Home Economics, New Mexico State University*. http://aces.nmsu.edu/pubs/_h/h-164.pdf Accessed on February 25, 2010
- ⁹⁵⁰ "Vermiculite." *Mineral Information Institute*. 2011. <http://www.mii.org/Minerals/photoverm.html>.
- ⁹⁵¹ "Aerated (Turned) Windrow Composting." *U.S. Environmental Protection Agency*.
<http://www.epa.gov/osw/conserves/rrr/composting/windrow.htm>